

K16 Series

Ø16mm Switches/Buttons



















- 16mm (5/8") Mounting Holes
- IP 65 degree of protection (Water & dust proof)
- Snap action contacts
- Illuminated Mushroom & Round, square, rectangular heads (Selector switches are optional)
- Useful quick connector (tap #110) or available solder socket or PCB pin sockets
- Flush mountable switches available - see page F4

Specifications

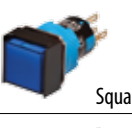
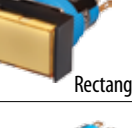
Contacts	Contact Arrangement	SPDT (1C), DPDT (2C)
	Contact Material	Ag Alloy (24K Gold plated)
	Rated Insulation Voltage	250VAC
	Rated Operating Current	3A MAX
	Max. On/Off Voltage	250VAC, 110VDC
	Rated Load	1A at 24VDC/ 120VAC, 0.5A at 250VAC
	Max. Applicable Load	1mA 5VDC
LED	Regular Voltage	24VDC, 12VDC, 6VDC
	Norminal Current	15mA Approx.
	Expected Life	50,000hrs
Buzzer	Sound	80dB continous alert sound at 0.1m
	Voltage/Current	24VDC/15mA Approx.

General Spec	Contact Resistance	Max. 50mΩ	
	Insulation Resistance	100MΩ at 500V DC	
	Dielectric Strength	2,000VAC for 1 Min.	
	Vibration Resistance	25~55Hz Dual amplitude : 0.75mm	
	Shock Resistance	Endurance: 500m/s ² , Operatin error: 200m/s ²	
	Expected Life	Mechanical	Push Button (release): Min. 1,000,000
			Selector, Key Selector: 250,000
	Expected Life	Electrical	Others: Min. 100,000
			Maintained: Min. 50,000 (frequency 1,200 times/hrs)
	Ambient Temperature	Operation: -25°C~ +55°C, Storage: -30°C~+80°C	Others: Min. 100,000
Ambient Humidity			45~85%RH
Degree of Protection	IP65		
Terminal Soldering Temp.	20W 5sec / 260°C 3sec		

	Style	Operation	Contact	Part Numbers		
				Non Illuminated	Illuminated	
Push Button		Momentary	SPDT DPDT	K16-211 K16-212	K16-271 - V K16-272 - V	
		Maintained	SPDT DPDT	K16-311 K16-312	K16-371 - V K16-372 - V	
		Momentary	SPDT DPDT	K16-221 K16-222	K16-281 - V K16-282 - V	
		Maintained	SPDT DPDT	K16-321 K16-322	K16-381 - V K16-382 - V	
		Momentary	SPDT DPDT	K16-231 K16-232	K16-291 - V K16-292 - V	
		Maintained	SPDT DPDT	K16-331 K16-332	K16-391 - V K16-392 - V	
Mushroom Switches		Momentary	SPDT DPDT	K16-911 K16-912	K16-971 - V K16-972 - V	
		Maintained	SPDT DPDT	K16-911H K16-912H	K16-971H - V K16-972H - V	
		Momentary	SPDT DPDT	K16-921 K16-922	K16-981 - V K16-982 - V	
		Maintained	SPDT DPDT	K16-921H K16-922H	K16-981H - V K16-982H - V	
		Momentary	SPDT DPDT	K16-931 K16-932	K16-991 - V K16-992 - V	
		Maintained	SPDT DPDT	K16-931H K16-932H	K16-991H - V K16-992H - V	
	E-Stop Switches		Turn to Release	SPDT DPDT	K16-811R K16-812R	K16-871- V K16-872- V
	Buzzers		80dB	N/A	K16-CZ	K16-CZL- V
		80dB	N/A	K16-BZ	K16-BZL- V	

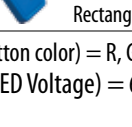
	Style	Operation	Contact	Part Numbers
Pilot Lamp		Pilot Lamp	N/A	K16-170 - V
		Pilot Lamp	N/A	K16-180 - V
		Pilot Lamp	N/A	K16-190 - V
Selector Switches		2 Step	SPDT DPDT	K16-411 K16-412
		3 Step	DPDT	K16-512
		2 Step	SPDT DPDT	K16-421 K16-422
		3 Step	DPDT	K16-522
		2 Step	SPDT DPDT	K16-431 K16-432
		3 Step	DPDT	K16-532
Key Selector Switches		2 Step	SPDT DPDT	⊗ K16-611 ⊗ K16-612
		3 Step	DPDT	⊕ K16-712
		2 Step	SPDT DPDT	⊗ K16-621 ⊗ K16-622
		3 Step	DPDT	⊕ K16-722
		2 Step	SPDT DPDT	⊗ K16-631 ⊗ K16-632
		3 Step	DPDT	⊕ K16-732

* (Button color) = R, G, Y, B, and W (Red, Green, Yellow, Blue, and White)
 * V (LED Voltage) = 6, 12, 24V DC & 110/220VAC with optional transformer

Dimensions

Pilot Lamps & Push Buttons

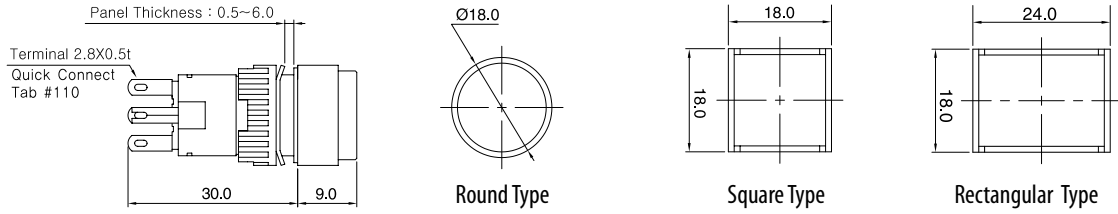

Selector Switches

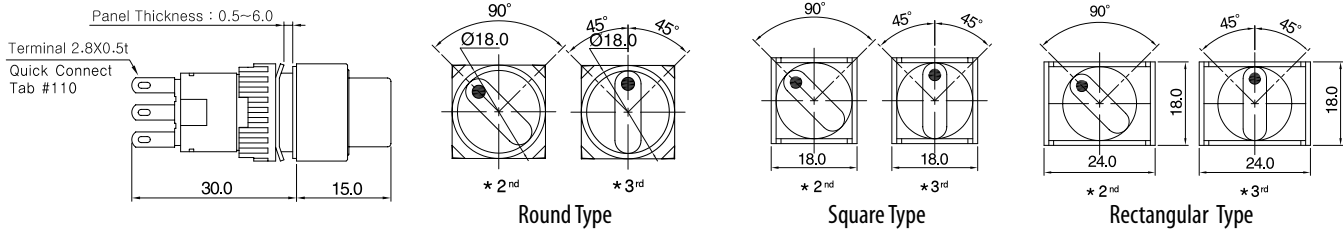

Key Switches

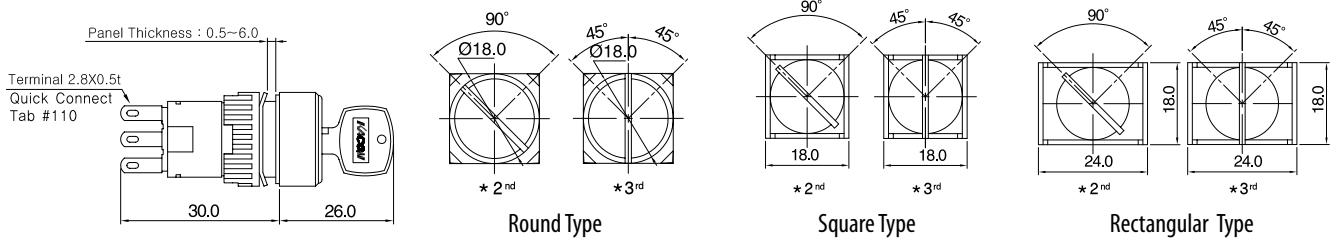

Mushroom Type Push Buttons

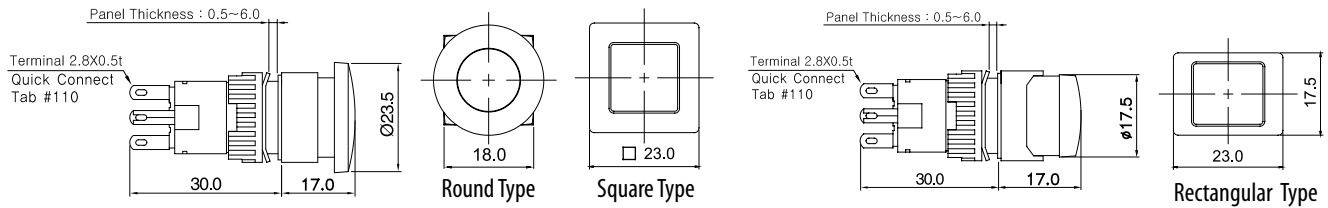

Buzzers

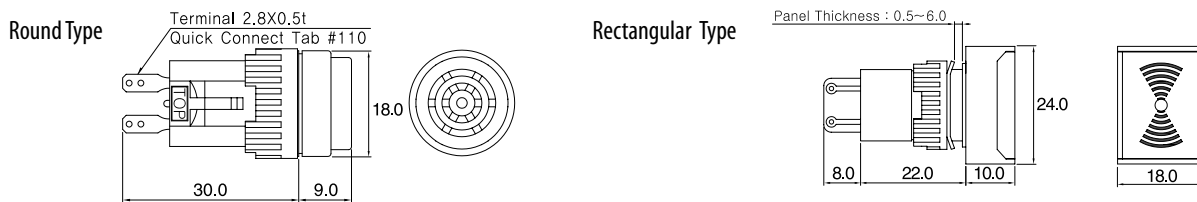

Emergency Resets

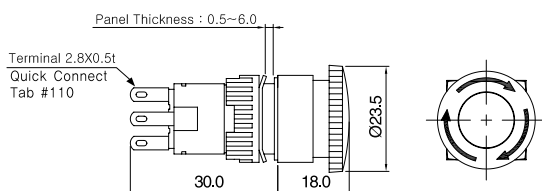

K16 Accessories

Protection Covers - Round & Square Type

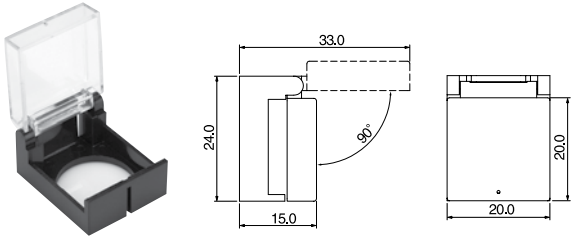

K16-S111 - Opens 90 degree

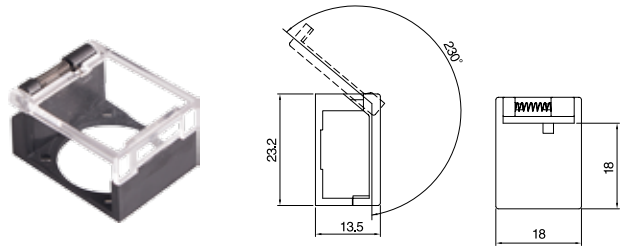

K16-S221 - Opens 230 degree

Protection Covers - Rectangular Type

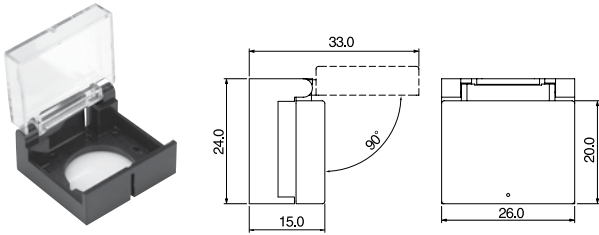

K16-S112 - Opens 90 degree

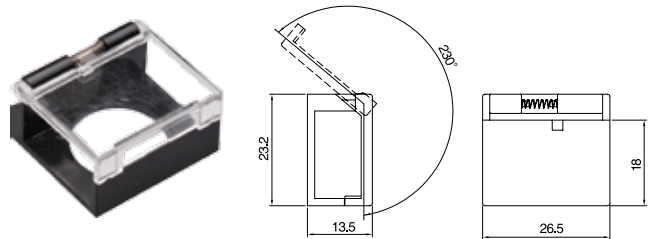

K16-S222 - Opens 230 degree

Safety Guard

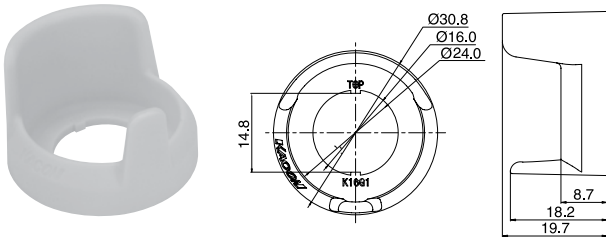

K16-G1

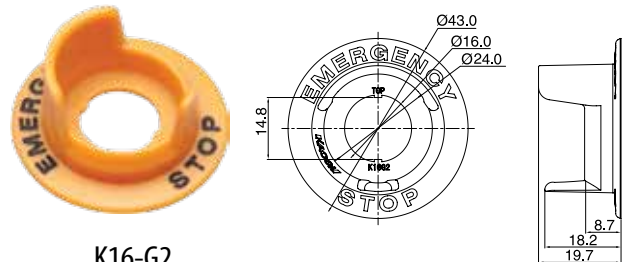

K16-G2

LED

K16-S115 - R, Y, G, B, C & 6, 12, 24VDC



Transformer

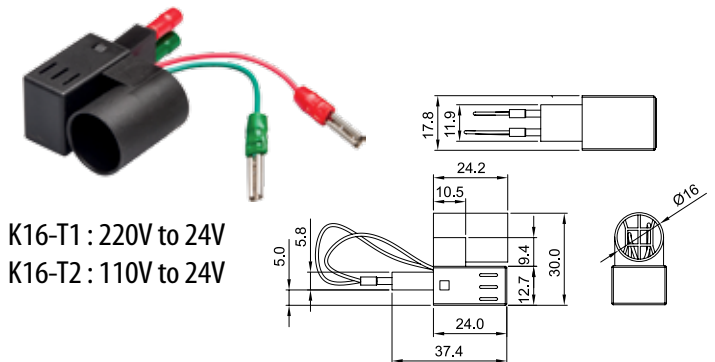

K16-T1 : 220V to 24V
K16-T2 : 110V to 24V

Hand Tools

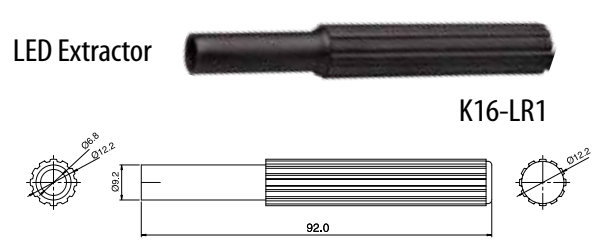
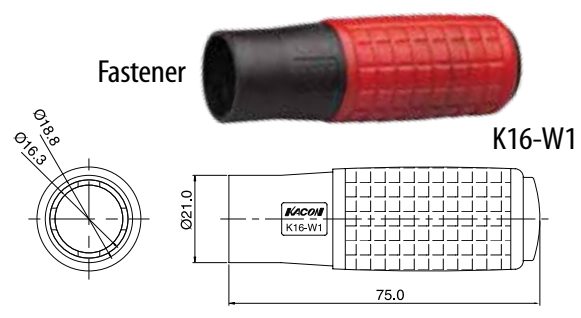

Sockets

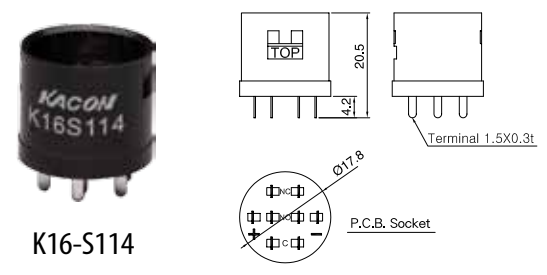
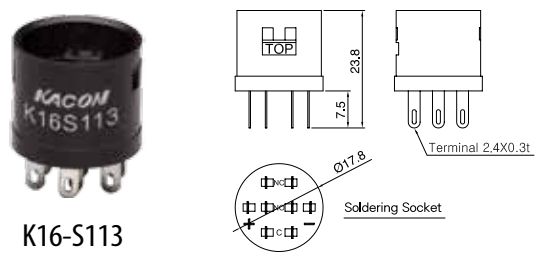

Terminal Protection Protection Cover R Type Lens



Flush Mounting Guide



Tower Lights

Beacon Lights

LED Indicators
Pilot Lamps

Buzzer Alarms

Pushbutton Switches

Limit Switches

Foot Switches

SSR

Relay & Sockets

Relay Terminal Blocks

Terminal Blocks

Fuse Holders

Enclosures

F4