



PS-S10 Series Specifications



Features:

- Universal AC input / full range
- Protections: Short Circuit / Overload / Overvoltage
- Cooling by free air convection
- DIN rail mountable
- NEC class 2 / LPS compliant
- Built in DC OK active signal
- LED indicator for power on
- No load power consumption < 0.75W
- 100% full load burn-in test
- 3 year warranty

OUTPUT

INPUT

PROTECTION

ENVIRONMENT

SAFETY & EMC

OTHERS

Cat. No.	PS-S1005	PS-S1012	PS-S1015	PS-S1024
DC VOLTAGE	5V	12V	15V	24V
RATED CURRENT	2A	0.84A	0.67A	0.42A
CURRENT RANGE	0~2A	0~0.84A	0~0.67A	0~0.42A
RATED POWER	10W	10W	10W	10W
RIPPLE & NOISE (max)	80mVp-p	120mVp-p	120mVp-p	150mVp-p
VOLTAGE TOLERANCE	±5.0%	±3.0%	±3.0%	±2.0%
LINE REGULATION	±1.0%	±1.0%	±1.0%	±1.0%
LOAD REGULATION	±5.0%	±3.0%	±3.0%	±2.0%
SETUP, RISE TIME	500ms, 30ms/230VAC; 1000ms, 30ms/115VAC at full load			
HOLD UP TIME (Typ.)	120ms/230VAC; 25ms/115VAC at full load			
VOLTAGE RANGE	85~264VAC; 120~370VDC			
FREQUENCY RANGE	47~63Hz			
EFFICIENCY (Typ.)	77%	81%	81%	84%
AC CURRENT (max.)	0.33A/115VAC; 0.21A/230VAC			
INRUSH CURRENT (Typ.)	COLD START: 35A/115VAC; 70A/230VAC			
LEAKAGE CURRENT	<1mA/ 240VAC			
OVERLOAD PROTECTION	Above 105% rated output power Protection type: Hiccup mode, recovers automatically after fault condition is removed			
OVER VOLTAGE PROTECTION	5.75~6.75V	13.8~16.2V	17.25~20.25V	27.6~32.4V
OVER TEMPERATURE PROTECTION	Power supply shut down at 70°C constant current limiting / output voltage goes to 0; re-power on to recover			
DC OK AKTIV SIGNAL (max.)	3.75~6V (50mA)	9~13.5V (40mA)	11.5~16.5V (40mA)	18~27V (20mA)
WORKING TEMP.	-20 ~ +70°C (Refer to output load derating curve)			
WORKING HUMIDITY	20 ~ 90% RH non-condensing			
STORAGE TEMP. / HUMIDITY	-40 ~ +85°C; 10 ~ 95% RH			
TEMP. COEFFICIENT	±0.03% /°C (0 ~ 50°C)			
VIBRATION	Component: 10 ~ 500Hz, 2G 10min. / 1cycle, 60 min. each long X,Y, Z axes			
MOUNTING	Compliance to IEC60068-2-6			
SAFETY STANDARDS	UL508 EN60950-1 approved NEC class2 / LPS compliant			
WITHSTAND VOLTAGE	I/P-O/P: 3KVAC I/P-FG: 1.5KVAC O/P-FG: 0.5KVAC			
ISOLATION RESISTANCE	I/P-O/P, I/P-FG, O/P-FG: 100M Ohms/500VDC			
EMI CONDUCTION & RADIATION	Compliance to EN55011 EN55022 (CISPR22) EN61204-3 Class B			
HARMONIC CURRENT	Compliance to EN61000-3-2,-3			
EMS IMMUNITY	Compliance to EN61000-4-2,3,4,5,6,8,11; EN55024; ENV50204; EN61000-6-1;EN61204-3; light industry level; criteria A			
MTBF	584K hrs min. MIL-HDBK-217K (25°C)			
DIMENSION	22.5x90x100mm (WxHxD)			
PACKING	0.17Kg; 72pcs / 13.2Kg / 0.91CUFT			

All parameters NOT specially mentioned are measured at 230V AC input, rated load and 25°C of ambient temperature

Mechanical Specification

Terminal Pin. No Assign. (TB1)

Pin No.	Assignment
1	FG ⊕
2	AC/N
3	AC/L

Terminal Pin. No Assign. (TB2)

Pin No.	Assignment
4	DC OUTPUT +V
5	DC OUTPUT -V
6	DC OK SIGNAL

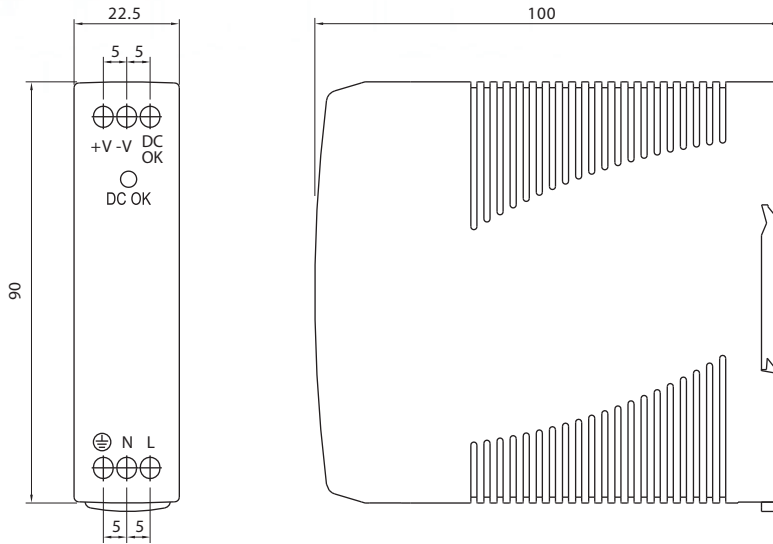

Block Diagram

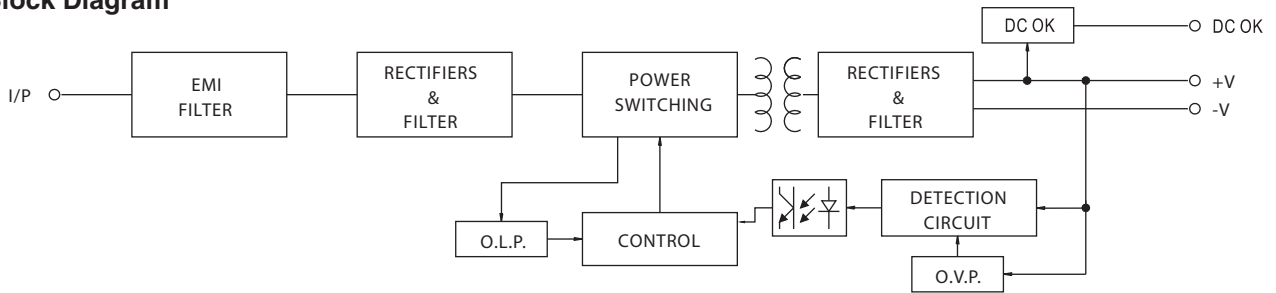

Application of DC OK Signal

(a) 5V signal

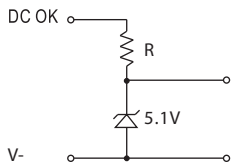

Model	R
5V	≧ 200Ω
12V	≧ 1.5KΩ
15V	≧ 2KΩ
24V	≧ 3.9KΩ

(b) LED

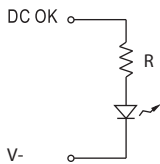

Model	R
5V	≧ 1KΩ
12V	≧ 2.4KΩ
15V	≧ 3KΩ
24V	≧ 4.7KΩ

(c) Relay

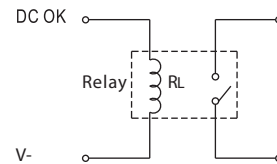

Model	RL
5V	≧ 120Ω
12V	≧ 700Ω
15V	≧ 700Ω
24V	≧ 1.2KΩ

Derating Curve

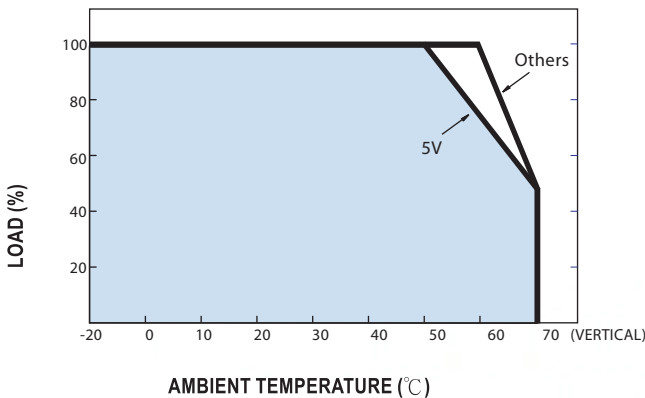

Output Derating VS Input Voltage

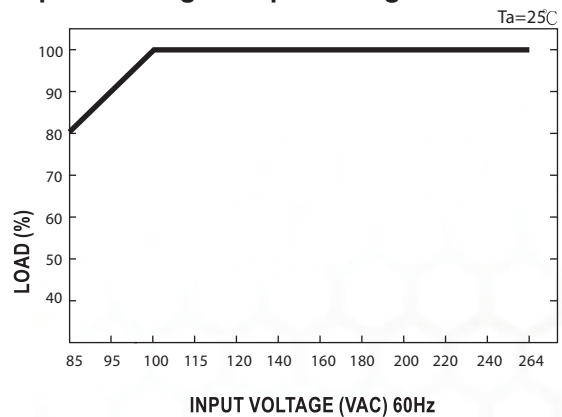

Note: All dimensions are in millimeters, to convert to inches multiply by 0.03937.