

L-Series

AC or DC

Miniature Molded Case Circuit Breakers



UL489 Listed Circuit Breakers

- Available in AC and DC models
- DIN Rail Mounted
- 17.5mm width
- Thermal Magnetic
- 240V, 480Y/277V AC, 50/60Hz
- 125VDC (1 pole); 250VDC (2pole)
- Short Circuit Interrupt Capacity 10kA
- Positive Trip indicator (Green - off/tripped, Red - on)
- HACR Type 40°C
- Line/Load reversible

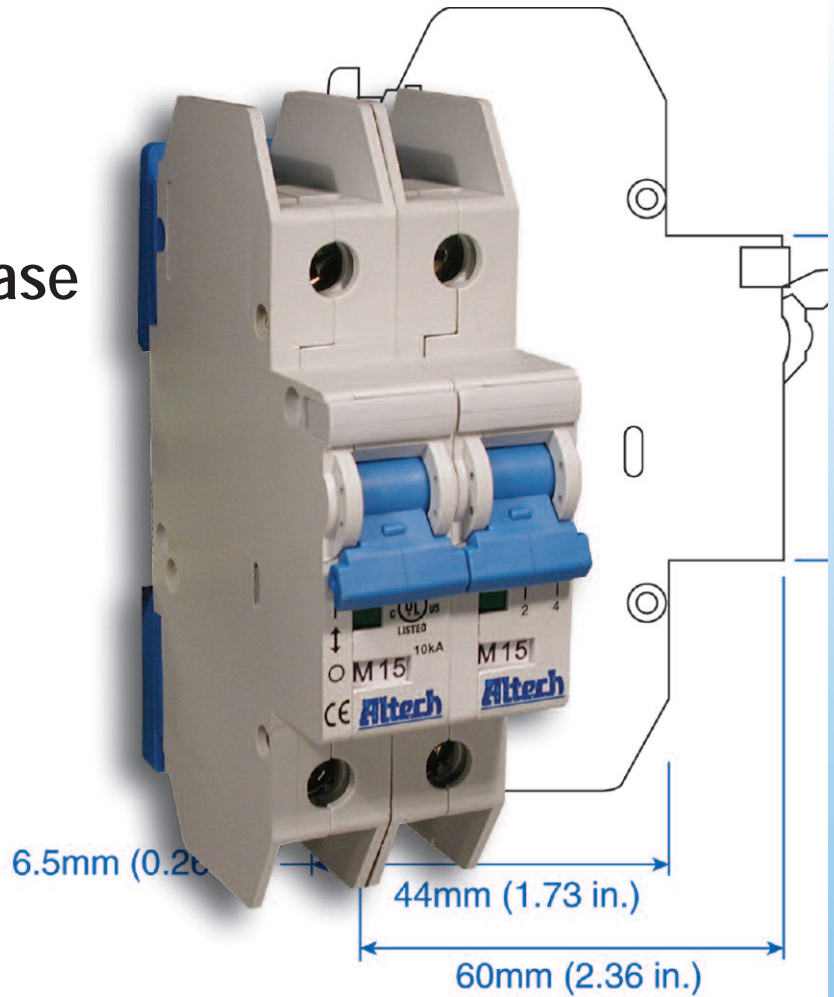

Current/ Voltage Rating	0.2-63A/240VAC, 0.2-32A/480Y/277VAC 0.2-63A/125/250VDC
Calibration Temperature	40°C (104°F)
Terminal Size Acceptability - min/max	2.5mm ² (12 AWG) / 25mm ² (3 AWG)
Terminal Torque - min/max	1.5 Nm (13 lbs. in.) / 2 Nm (17.5 lb. in.)
Terminal Protection Degree	IP20
Electrical Life	6000 cycles on/off
Mechanical Life	100000 cycles on/off
Wire Connection	copper wire only 60/75°C

AC - SHORT CIRCUIT INTERRUPT RATING

No. Poles	Type	0.2-32A	33-63A
1	AC	10kA@120, 240, 277V	10kA@120, 240V
2-4	AC	10kA@120, 240V, 480Y/277V	10kA@120, 240V

DC - SHORT CIRCUIT INTERRUPT RATING

No. Poles	Type	0.2-32A	33-63A
1	DC	10kA@125V	10kA@125V
2	DC	10kA@250V	10kA@250V

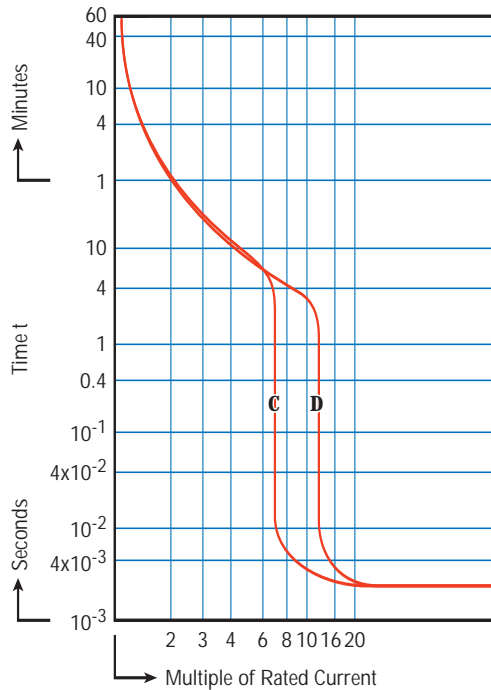

Time versus Current Trip Curve

For the exact trip curve, please refer to page 48.

Dimensions in mm side view

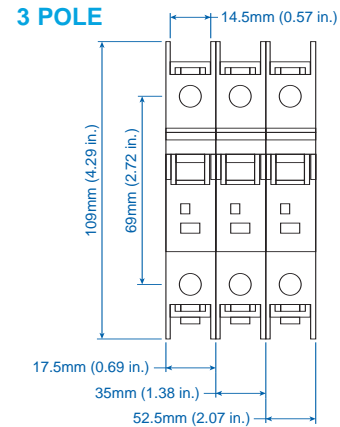
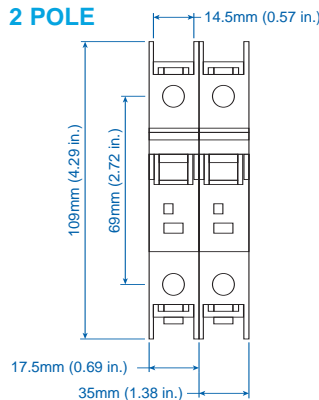
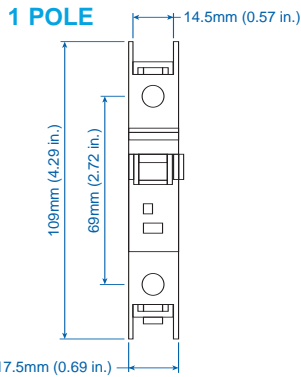
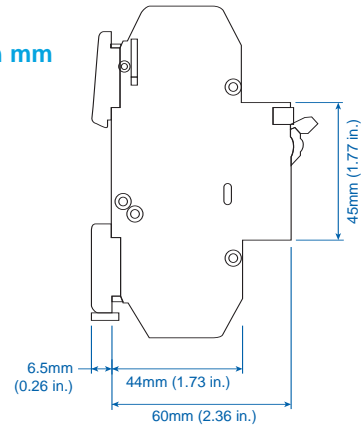

Trip-Characteristics*				Type	Applications						
Characteristic Trip Boundaries					Lighting Wiring Protection Control Circuits	Business Equipment Appliances	Transformers	Power Supplies Heaters	Motors		Reactive Load
Thermal Trip		Magnetic Trip							Low Inrush	High Inrush	
Must not Trip > 100ms	Must Trip < 1hr	Must not Trip > 100ms	Must Trip at 100ms								
C-Characteristics											
1.05xRC	1.3xRC	5xRC	10xRC	AC							
1.05xRC	1.3xRC	5xRC	10xRC	DC							
D-Characteristics											
1.05xRC	1.3xRC	10xRC	16xRC	AC							
1.05xRC	1.3xRC	10xRC	16xRC	DC							

*The value of each characteristic is shown vertically beneath its corresponding heading.



Warning!

This information should only be used as a selection guide. The use of a Miniature Circuit Breaker in an application with a certain Trip-Characteristic always requires prototype testing! It is the responsibility of the circuit design engineer to select the appropriate Miniature Circuit Breaker for his specific application.

AC C-Trip Characteristics

Application Examples:
 Low inrush motors, resistive loads, wiring protection, receptacles, lighting, and control circuit applications. Relatively short thermal trip delay and medium magnetic trip point.



LISTED
 E305318



One Pole

Rated Current	Type/ Cat. No.
0.2A	1CU02L
0.5A	1CU05L
1.0A	1CU1L
1.6A	1CU1.6L
2.0A	1CU2L
3.0A	1CU3L
4.0A	1CU4L
5.0A	1CU5L
6.0A	1CU6L
8.0A	1CU8L
10A	1CU10L
12A	1CU12L
13A	1CU13L
15A	1CU15L
16A	1CU16L
20A	1CU20L
25A	1CU25L
30A	1CU30L
32A	1CU32L
40A	1CU40L
50A	1CU50L
60A	1CU60L
63A	1CU63L

Standard Pack: 12
 Weight: 1.7kg (3.74 lb.)



Two Pole

Rated Current	Type/ Cat. No.
0.2A	2CU02L
0.5A	2CU05L
1.0A	2CU1L
1.6A	2CU1.6L
2.0A	2CU2L
3.0A	2CU3L
4.0A	2CU4L
5.0A	2CU5L
6.0A	2CU6L
8.0A	2CU8L
10A	2CU10L
12A	2CU12L
13A	2CU13L
15A	2CU15L
16A	2CU16L
20A	2CU20L
25A	2CU25L
30A	2CU30L
32A	2CU32L
40A	2CU40L
50A	2CU50L
60A	2CU60L
63A	2CU63L

Standard Pack: 6
 Weight: 1.7kg (3.74 lb.)



Three Pole

Rated Current	Type/ Cat. No.
0.2A	3CU02L
0.5A	3CU05L
1.0A	3CU1L
1.6A	3CU1.6L
2.0A	3CU2L
3.0A	3CU3L
4.0A	3CU4L
5.0A	3CU5L
6.0A	3CU6L
8.0A	3CU8L
10A	3CU10L
12A	3CU12L
13A	3CU13L
15A	3CU15L
16A	3CU16L
20A	3CU20L
25A	3CU25L
30A	3CU30L
32A	3CU32L
40A	3CU40L
50A	3CU50L
60A	3CU60L
63A	3CU63L

Standard Pack: 4
 Weight: 1.7kg (3.74 lb.)

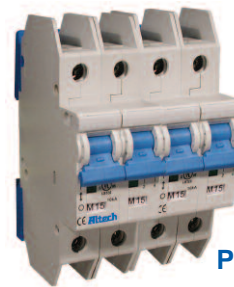

Four Pole
 Please contact
 Altech.

AC D-Trip Characteristics



LISTED
E305318

Application Examples:
Low inrush motors, resistive loads, wiring protection, receptacles, lighting, and control circuit applications. Relatively short thermal trip delay and medium magnetic trip point.



One Pole

Rated Current	Type/ Cat. No.
0.2A	1DU02L
0.5A	1DU05L
1.0A	1DU1L
1.6A	1DU1.6L
2.0A	1DU2L
3.0A	1DU3L
4.0A	1DU4L
5.0A	1DU5L
6.0A	1DU6L
8.0A	1DU8L
10A	1DU10L
12A	1DU12L
13A	1DU13L
15A	1DU15L
16A	1DU16L
20A	1DU20L
25A	1DU25L
30A	1DU30L
32A	1DU32L
40A	1DU40L
50A	1DU50L
60A	1DU60L
63A	1DU63L

Standard Pack: 12
Weight: 1.7kg (3.74 lb.)

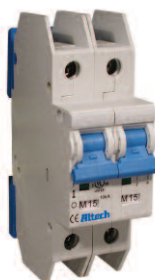

Two Pole

Rated Current	Type/ Cat. No.
0.2A	2DU02L
0.5A	2DU05L
1.0A	2DU1L
1.6A	2DU1.6L
2.0A	2DU2L
3.0A	2DU3L
4.0A	2DU4L
5.0A	2DU5L
6.0A	2DU6L
8.0A	2DU8L
10A	2DU10L
12A	2DU12L
13A	2DU13L
15A	2DU15L
16A	2DU16L
20A	2DU20L
25A	2DU25L
30A	2DU30L
32A	2DU32L
40A	2DU40L
50A	2DU50L
60A	2DU60L
63A	2DU63L

Standard Pack: 6
Weight: 1.7kg (3.74 lb.)



Three Pole

Rated Current	Type/ Cat. No.
0.2A	3DU02L
0.5A	3DU05L
1.0A	3DU1L
1.6A	3DU1.6L
2.0A	3DU2L
3.0A	3DU3L
4.0A	3DU4L
5.0A	3DU5L
6.0A	3DU6L
8.0A	3DU8L
10A	3DU10L
12A	3DU12L
13A	3DU13L
15A	3DU15L
16A	3DU16L
20A	3DU20L
25A	3DU25L
30A	3DU30L
32A	3DU32L
40A	3DU40L
50A	3DU50L
60A	3DU60L
63A	3DU63L

Standard Pack: 4
Weight: 1.7kg (3.74 lb.)

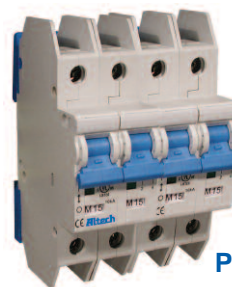

Four Pole
Please contact
Altech.

DC C-Trip Characteristics

Application Examples:
Telecommunication equipment,
computer equipment, uninterruptable
power supplies.



LISTED
E305318



One Pole

Rated Current	Type/ Cat. No.
0.2A	DC1CU02L
0.5A	DC1CU05L
1.0A	DC1CU1L
1.6A	DC1CU1.6L
2.0A	DC1CU2L
3.0A	DC1CU3L
4.0A	DC1CU4L
5.0A	DC1CU5L
6.0A	DC1CU6L
8.0A	DC1CU8L
12A	DC1CU12L
10A	DC1CU10L
13A	DC1CU13L
15A	DC1CU15L
16A	DC1CU16L
20A	DC1CU20L
25A	DC1CU25L
30A	DC1CU30L
32A	DC1CU32L
40A	DC1CU40L
50A	DC1CU50L
60A	DC1CU60L
63A	DC1CU63L

Standard Pack: 12
Weight: 1.7kg (3.74 lb.)



Two Pole

Rated Current	Type/ Cat. No.
0.2A	DC2CU02L
0.5A	DC2CU05L
1.0A	DC2CU1L
1.6A	DC2CU1.6L
2.0A	DC2CU2L
3.0A	DC2CU3L
4.0A	DC2CU4L
5.0A	DC2CU5L
6.0A	DC2CU6L
8.0A	DC2CU8L
12A	DC2CU12L
10A	DC2CU10L
13A	DC2CU13L
15A	DC2CU15L
16A	DC2CU16L
20A	DC2CU20L
25A	DC2CU25L
30A	DC2CU30L
32A	DC2CU32L
40A	DC2CU40L
50A	DC2CU50L
60A	DC2CU60L
63A	DC2CU63L

Standard Pack: 6
Weight: 1.7kg (3.74 lb.)



One Pole

Rated Current	Type/ Cat. No.
0.2A	DC1DU02L
0.5A	DC1DU05L
1.0A	DC1DU1L
1.6A	DC1DU1.6L
2.0A	DC1DU2L
3.0A	DC1DU3L
4.0A	DC1DU4L
5.0A	DC1DU5L
6.0A	DC1DU6L
8.0A	DC1DU8L
12A	DC1DU12L
10A	DC1DU10L
13A	DC1DU13L
15A	DC1DU15L
16A	DC1DU16L
20A	DC1DU20L
25A	DC1DU25L
30A	DC1DU30L
32A	DC1DU32L
40A	DC1DU40L
50A	DC1DU50L
60A	DC1DU60L
63A	DC1DU63L

Standard Pack: 12
Weight: 1.7kg (3.74 lb.)



Two Pole

Rated Current	Type/ Cat. No.
0.2A	DC2DU02L
0.5A	DC2DU05L
1.0A	DC2DU1L
1.6A	DC2DU1.6L
2.0A	DC2DU2L
3.0A	DC2DU3L
4.0A	DC2DU4L
5.0A	DC2DU5L
6.0A	DC2DU6L
8.0A	DC2DU8L
12A	DC2DU12L
10A	DC2DU10L
13A	DC2DU13L
15A	DC2DU15L
16A	DC2DU16L
20A	DC2DU20L
25A	DC2DU25L
30A	DC2DU30L
32A	DC2DU32L
40A	DC2DU40L
50A	DC2DU50L
60A	DC2DU60L
63A	DC2DU63L

Standard Pack: 6
Weight: 1.7kg (3.74 lb.)

L-Series Trip Curves

**C and D Trip
Less than 10A**

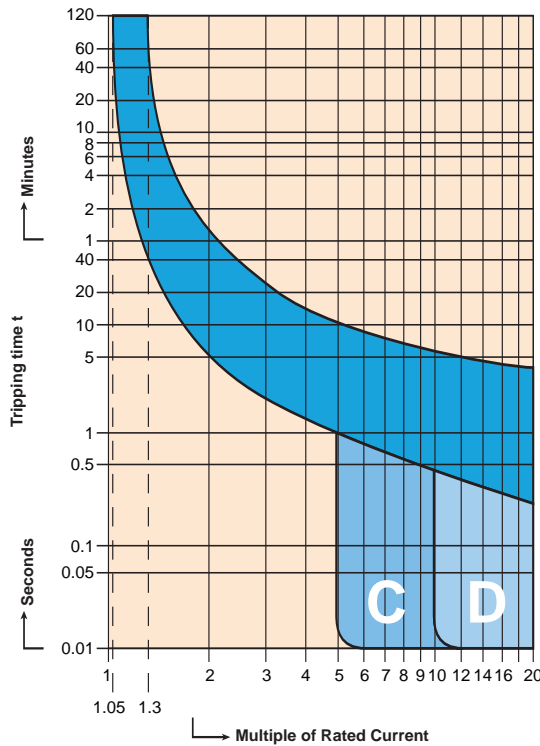

**C and D Trip
10A and higher**

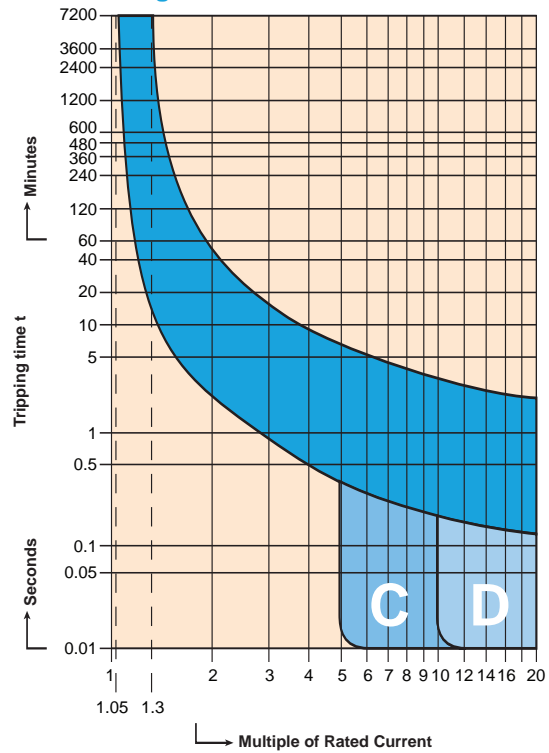

Temperature and Power Loss Specifications

Rated current I _n (A)	Effective rated current allowing for ambient temperature I _{cor} (A)									Internal impedance Z (mΩ) char. B, C, D, K	Power Loss B, C, D, K P (W)
	-20	-10	0	10	20	30	40	50	60		
0.2	0.24	0.24	0.23	0.22	0.21	0.2	0.19	0.18	0.17	45100.0	1.80
0.5	0.61	0.59	0.57	0.55	0.53	0.5	0.47	0.44	0.42	8000.0	2.00
1	1.21	1.18	1.14	1.1	1.05	1.0	0.93	0.88	0.83	2000.0	2.00
2	2.42	2.36	2.28	2.2	2.1	2.0	1.86	1.76	1.67	490.0	1.96
3	3.63	3.54	3.42	3.3	3.15	3.0	2.79	2.64	2.5	230.0	2.07
4	4.84	4.72	4.56	4.4	4.2	4.0	3.72	3.52	3.33	150.0	2.40
5	6.1	5.9	5.7	5.5	5.3	5.0	4.7	4.4	4.2	95.0	2.38
6	7.3	7.1	6.8	6.6	6.3	6.0	5.6	5.3	5.0	69.0	2.48
7	8.5	8.2	8.0	7.7	7.4	7.0	6.5	6.2	5.8	52.0	2.55
8	9.7	9.4	9.1	8.8	8.4	8.0	7.4	7.0	6.7	35.0	2.24
10	12.1	11.8	11.4	11.0	10.5	10.0	9.3	8.8	8.3	23.5	2.35
12	14.5	14.2	13.7	13.2	12.6	12.0	11.2	10.6	10.0	18.7	2.69
13	15.7	15.3	14.8	14.3	13.7	13.0	12.1	11.5	10.8	14.3	2.42
14	16.9	16.5	16.0	15.4	14.7	14.0	13.0	12.3	11.7	12.4	2.43
15	18.2	17.7	17.1	16.5	15.8	15.0	14.0	13.2	12.5	10.1	2.27
16	19.4	18.9	18.2	17.6	16.8	16.0	14.9	14.1	13.3	7.5	1.92
20	24.2	23.6	22.8	22.0	21.0	20.0	18.6	17.6	16.7	6.3	2.52
25	30.3	29.5	28.5	27.5	26.3	25.0	23.3	22.0	20.8	4.6	2.88
30	36.3	35.4	34.2	33.0	31.5	30.0	27.9	26.5	25.0	3.6	3.24
32	38.7	37.8	36.5	35.2	33.6	32.0	29.8	28.2	26.7	3.6	3.69
35	42.3	41.3	39.9	38.5	36.8	35.0	32.6	30.8	29.2	3.6	4.41
40	48.4	47.2	45.6	44.0	42.0	40.0	37.2	35.2	33.3	3.0	4.80
50	60.5	59.0	57.0	55.0	52.5	50.0	46.5	44.1	41.7	2.4	6.00
60	72.6	70.9	68.4	66.0	63.0	60.0	55.9	52.9	50.1	1.8	6.48

Accessories

L-Series Circuit Breakers



Accessories can be factory or field mounted on L-Series miniature molded case circuit breakers for enhanced control and monitoring capabilities. Field mounting kits include all necessary parts and instructions. Accessories can be gang mounted on a single controller (the Auxiliary Switch in the outside position). The mounting arrangement links the internal latch-pins for the tripping mechanisms, ensuring simultaneous trips. Handles are linked to simplify manual resetting.



Neutral Pole (63A/240VAC; 32A/480Y/277VAC)

Description	Type/ Cat. No.	Cable Max	Cable Min	Torque Max	Torque Min
Neutral	ALTN2L	25mm ² 3 AWG	2.5mm ² 12 AWG	2Nm 17.5 lb-in	1.5Nm 12 lb-in

Standard Pack: 10

Weight: 1.2kg (2.64 lb.)



Shunt Trip

Shunt Trip and Undervoltage Trip

Description	Shunt Trip Type/Cat. No.	Undervoltage Trip Type/Cat. No.	Cable Max	Cable Min	Torque Max	Torque Min
AC Coil:						
12V AC	FA12ACL	UV12ACL	25mm ² 3 AWG	2.5mm ² 12 AWG	2Nm 17.5 lb-in	1.5Nm 12 lb-in
24V AC	FA24ACL	UV24ACL				
48V AC	FA48ACL	UV48ACL				
60V AC	FA60ACL	UV60ACL				
110V AC	FA110ACL	UV110ACL				
120V AC	FA120ACL	UV120ACL				
230V AC	FA230ACL	UV230ACL				
277V AC	FA277ACL	UV277ACL				
400V AC	FA400ACL	UV400ACL				
DC Coil:						
12V DC	FA12DCL	UV12DCL	25mm ² 3 AWG	2.5mm ² 12 AWG	2Nm 17.5 lb-in	1.5Nm 12 lb-in
24V DC	FA24DCL	UV24DCL				
48V DC	FA48DCL	UV48DCL				
110V DC	FA110DCL	UV110DCL				

Standard Pack: 10

Weight: 1.1kg (2.43 lb.)



Undervoltage Trip

Auxiliary Contact (6A/120VAC; 3A/240VAC)

Description	Type/ Cat. No.	Cable Max	Cable Min	Torque Max	Torque Min
1 x CO	H1COL	2.5mm ² 12 AWG	0.5mm ² 20 AWG	0.5Nm 4 lb-in	0.33Nm 3 lb-in
2 x CO	H2COL				
1 x CO, 1 Signal & Test Button	HSTCOL				

Standard Pack: 15

Weight: 0.5kg (1.32 lb.)



Lockon, Lockoff Adaptor

Description	Type/ Cat. No.
Yellow	EASS2L

Standard Pack: 10

Weight: 50g (1.76 oz.)

