

User Manual

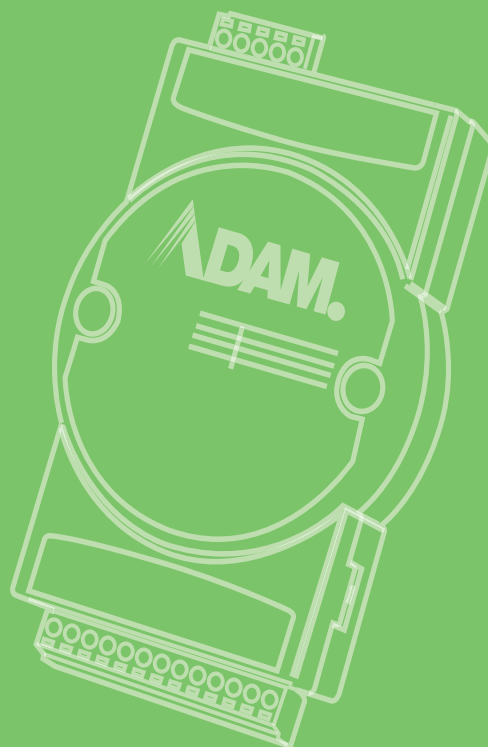

ADAM-6300 Series

IoT OPC UA Ethernet I/O
Modules

ADVANTECH

Enabling an Intelligent Planet

Copyright

The documentation and the software included with this product are copyrighted 2021 by Advantech Co., Ltd. All rights are reserved. Advantech Co., Ltd. reserves the right to make improvements in the products described in this manual at any time without notice. No part of this manual may be reproduced, copied, translated or transmitted in any form or by any means without the prior written permission of Advantech Co., Ltd. Information provided in this manual is intended to be accurate and reliable. However, Advantech Co., Ltd. assumes no responsibility for its use, nor for any infringements of the rights of third parties, which may result from its use.

Acknowledgements

Intel and Pentium are trademarks of Intel Corporation.

Microsoft Windows and MS-DOS are registered trademarks of Microsoft Corp.

All other product names or trademarks are properties of their respective owners.

Product Warranty

Advantech warrants to you, the original purchaser, that each of its products will be free from defects in materials and workmanship for two years from the date of purchase.

This warranty does not apply to any products which have been repaired or altered by persons other than repair personnel authorized by Advantech, or which have been subject to misuse, abuse, accident or improper installation. Advantech assumes no liability under the terms of this warranty as a consequence of such events.

Because of Advantech's high quality-control standards and rigorous testing, most of our customers never need to use our repair service. If an Advantech product is defective, it will be repaired or replaced at no charge during the warranty period. For out-of-warranty repairs, you will be billed according to the cost of replacement materials, service time and freight. Please consult your dealer for more details.

If you think you have a defective product, follow these steps:

1. Collect all the information about the problem encountered. (For example, CPU speed, Advantech products used, other hardware and software used, etc.) Note anything abnormal and list any onscreen messages you get when the problem occurs.
2. Call your dealer and describe the problem. Please have your manual, product, and any helpful information readily available.
3. If your product is diagnosed as defective, obtain an RMA (return merchandise authorization) number from your dealer. This allows us to process your return more quickly.
4. Carefully pack the defective product, a fully-completed Repair and Replacement Order Card and a photocopy proof of purchase date (such as your sales receipt) in a shippable container. A product returned without proof of the purchase date is not eligible for warranty service.
5. Write the RMA number visibly on the outside of the package and ship it prepaid to your dealer.

Declaration of Conformity

CE

This product has passed the CE test for environmental specifications when shielded cables are used for external wiring. We recommend the use of shielded cables. This type of cable is available from Advantech. Please contact your local supplier for ordering information.

Test conditions for passing also include the equipment being operated within an industrial enclosure. In order to protect the product from damage caused by electrostatic discharge (ESD) and EMI leakage, we strongly recommend the use of CE-compliant industrial enclosure products.

FCC Class A

This equipment has been tested and found to comply with the limits for a Class A digital device, pursuant to part 15 of the FCC Rules. These limits are designed to provide reasonable protection against harmful interference when the equipment is operated in a commercial environment. This equipment generates, uses, and can radiate radio frequency energy and, if not installed and used in accordance with the instruction manual, may cause harmful interference to radio communications. Operation of this equipment in a residential area is likely to cause harmful interference. In this event, users are required to correct the interference at their own expense.

Technical Support and Assistance

1. Visit the Advantech web site at www.advantech.com/support where you can find the latest information about the product.
2. Contact your distributor, sales representative, or Advantech's customer service center for technical support if you need additional assistance. Please have the following information ready before you call:
 - Product name and serial number
 - Description of your peripheral attachments
 - Description of your software (operating system, version, application software, etc.)
 - A complete description of the problem
 - The exact wording of any error messages

Safety Instructions

1. Read these safety instructions carefully.
2. Keep this User Manual for later reference.
3. Disconnect this equipment from any AC outlet before cleaning. Use a damp cloth. Do not use liquid or spray detergents for cleaning.
4. For plug-in equipment, the power outlet socket must be located near the equipment and must be easily accessible.
5. Keep this equipment away from humidity.
6. Put this equipment on a reliable surface during installation. Dropping it or letting it fall may cause damage.
7. The openings on the enclosure are for air convection. Protect the equipment from overheating. **DO NOT COVER THE OPENINGS.**
8. Make sure the voltage of the power source is correct before connecting the equipment to the power outlet.
9. Position the power cord so that people cannot step on it. Do not place anything over the power cord.
10. All cautions and warnings on the equipment should be noted.
11. If the equipment is not used for a long time, disconnect it from the power source to avoid damage by transient overvoltage.
12. Never pour any liquid into an opening. This may cause fire or electrical shock.
13. Never open the equipment. For safety reasons, the equipment should be opened only by qualified service personnel.
14. If one of the following situations arises, get the equipment checked by service personnel:
 - The power cord or plug is damaged.
 - Liquid has penetrated into the equipment.
 - The equipment has been exposed to moisture.
 - The equipment does not work well, or you cannot get it to work according to the user's manual.
 - The equipment has been dropped and damaged.
 - The equipment has obvious signs of breakage.
15. **DO NOT LEAVE THIS EQUIPMENT IN AN ENVIRONMENT WHERE THE STORAGE TEMPERATURE MAY GO BELOW -25°C OR ABOVE 70°C. THIS COULD DAMAGE THE EQUIPMENT. THE EQUIPMENT SHOULD BE IN A CONTROLLED ENVIRONMENT.**
16. **CAUTION: DANGER OF EXPLOSION IF BATTERY IS INCORRECTLY REPLACED. REPLACE ONLY WITH THE SAME OR EQUIVALENT TYPE RECOMMENDED BY THE MANUFACTURER, DISCARD USED BATTERIES ACCORDING TO THE MANUFACTURER'S INSTRUCTIONS.**

Contents

Chapter 1	Product Overview	1
1.1	ADAM-6300 Introduction	2
1.2	Features	2
1.3	Hardware Introduction	2
1.3.1	Front Name Plate	2
	Figure 1.1 Front Name Plate	2
1.3.2	Power Connection	3
	Figure 1.2 Power Connector	3
1.3.3	Ethernet Connector and Grounding Screw	3
	Figure 1.3 Ethernet Connector and Grounding Screw	3
1.3.4	LED Definition	3
1.3.5	Dimensions	4
	Figure 1.4 ADAM-6300 Dimensions	4
1.4	Package Information	4
Chapter 2	Hardware Installation	5
2.1	Mounting: DIN rail	6
	Figure 2.1 DIN Rail Adapter	6
2.2	Power Supply Wiring	6
2.3	I/O Module Wiring	7
Chapter 3	Introduction to Digital I/O	9
3.1	Specifications	10
3.1.1	General	10
3.1.2	Protection	10
3.1.3	Environment	10
3.1.4	OPC UA Specification	10
3.2	Digital Input/Output Modules (ADAM-6350)	11
3.2.1	Specifications	11
3.2.2	Application Wiring	11
	Figure 3.1 Application Wiring (Top View)	11
	Figure 3.2 Application Wiring (Side View)	12
	Figure 3.3 DO Output Wiring (Resistive and inductive load)	12
3.3	Analog Input Modules (ADAM-6317)	13
3.3.1	Specifications	13
3.3.2	Application Wiring	13
	Figure 3.4 Analog Input Wiring	13
	Figure 3.5 Digital Input Wiring	14
	Figure 3.6 Digital Output Wiring	14
	Figure 3.7 "U"(Upper) and Bottom Terminal Block	14
3.4	SSR Relay Output Module Modules (ADAM-6360D)	15
3.4.1	Specifications	15
3.4.2	Application Wiring	16
	Figure 3.8 Relay Output Wiring	16
	Figure 3.9 Digital Input Wiring	16
	Figure 3.10 Digital Output Wiring	17
	Figure 3.11 U (Upper) and Bottom Terminal Block	17
3.5	Relay Output Module Modules (ADAM-6366)	18
3.5.1	Specifications	18
3.5.2	Application Wiring	19
	Figure 3.12 Relay Output Wiring	19

Figure 3.13 Digital Input Wiring	19
Figure 3.14 Digital Output Wiring	20
Figure 3.15 U (Upper) and Bottom Terminal Block	20

Chapter 4 System Configuration..... 21

4.1	System Requirements.....	22
4.2	Installing Adam/Apax .NET Utility	22
4.3	Adam/Apax .NET Utility Overview	23
	Figure 4.1 Adam/Apax .NET Utility Operation Window	23
4.3.1	Menu Bar	24
4.3.2	Toolbar.....	25
	Figure 4.2 Adam/Apax .NET Utility Toolbar.....	25
4.3.3	Module Tree Display Area	26
	Figure 4.3 Adam/Apax .NET Utility Module Display Area.....	26
4.3.4	Status Display Area	26
4.4	Configuration of ADAM-6300 Modules	27
4.4.1	The Information Tab	28
4.4.2	The Network Tab	28
4.4.3	The Administration Tab.....	29
4.4.4	The Firmware Tab	29
4.5	Getting started: The Connection of OPC UA Server and Client	30
	Figure 4.4 Flowchart for getting started guide, the connection of OPC UA Server (ADAM-6300) and Client (Adam/Apax .NET Utility)	30
4.5.1	Network and I/O type setting	30
4.5.2	Connection of OPC UA Server and OPC UA Client	33
4.6	I/O Configuration.....	38
4.6.1	Analog Input.....	38
4.6.2	Digital input.....	46
4.6.3	Digital Output.....	53
4.6.4	SSR Relay Output	61

Appendix A Modbus Table..... 63

A.1	ADAM-6317: 8AI/11DI/10DO IoT Modbus/OPC UA Ethernet Remote I/O . 64	
A.2	ADAM-6350: 18DI/18DO IoT Modbus/OPC UA Ethernet Remote I/O....	69
A.3	ADAM-6360D: 8Relay(SSR)/14DI/6DO IoT Modbus/OPC UA Ethernet Remote I/O.....	73
A.4	ADAM-6366: 6 Relay /18 DI/ 6 DO IoT Modbus/OPC UA Ethernet Remote I/O	77

Chapter 1

Product Overview

1.1 ADAM-6300 Introduction

Advantech's ADAM-6300 series are highly-secure groundbreaking remote I/O modules supporting OPC UA without the need of gateways. They can link directly to SCADA and cloud, accelerating OT and IT convergence. ADAM-6300 series are equipped with security IC, OPC UA security certificate and encryption. Their high I/O density and support for daisy-chaining make ADAM-6300 series a highly integrated and cost-effective remote I/O solution.

1.2 Features

- 1. Uniquely-designed remote I/O with OPC UA protocol.
- 2. Remote I/O directly links to SCADA and cloud, accelerating OT and IT convergence.
- 3. Additional OPC UA provides security certificate and encryption.
- 4. Most integrated and cost effective- high I/O density and support of daisy-chaining.

1.3 Hardware Introduction

1.3.1 Front Name Plate

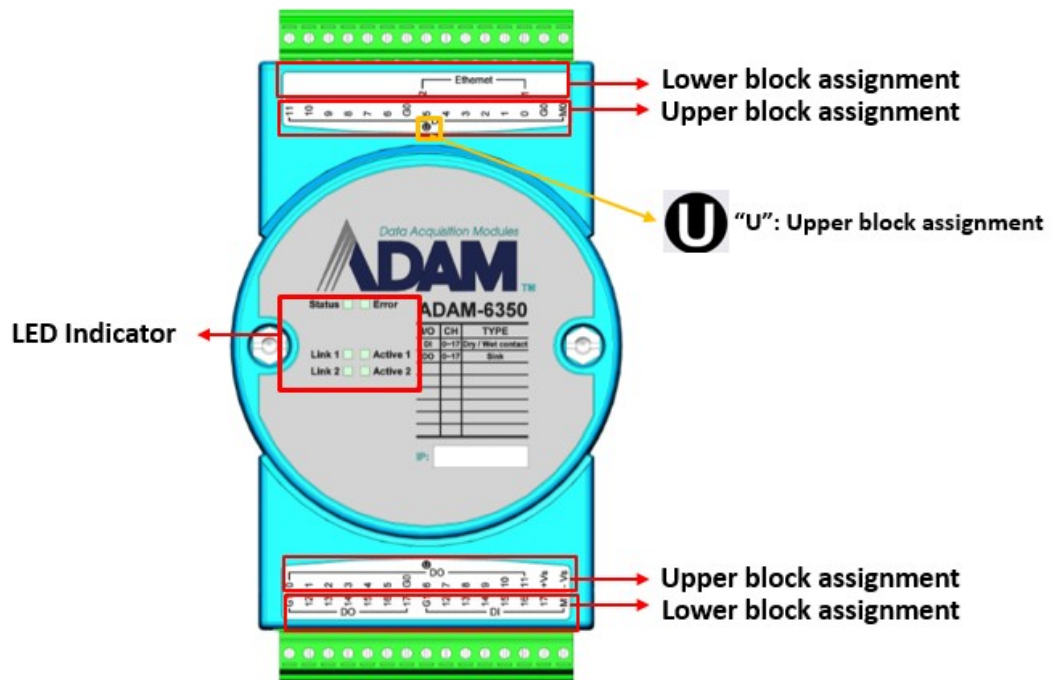

Figure 1.1 Front Name Plate

"U" icon in I/O label means Upper block assignment.

1.3.2 Power Connection

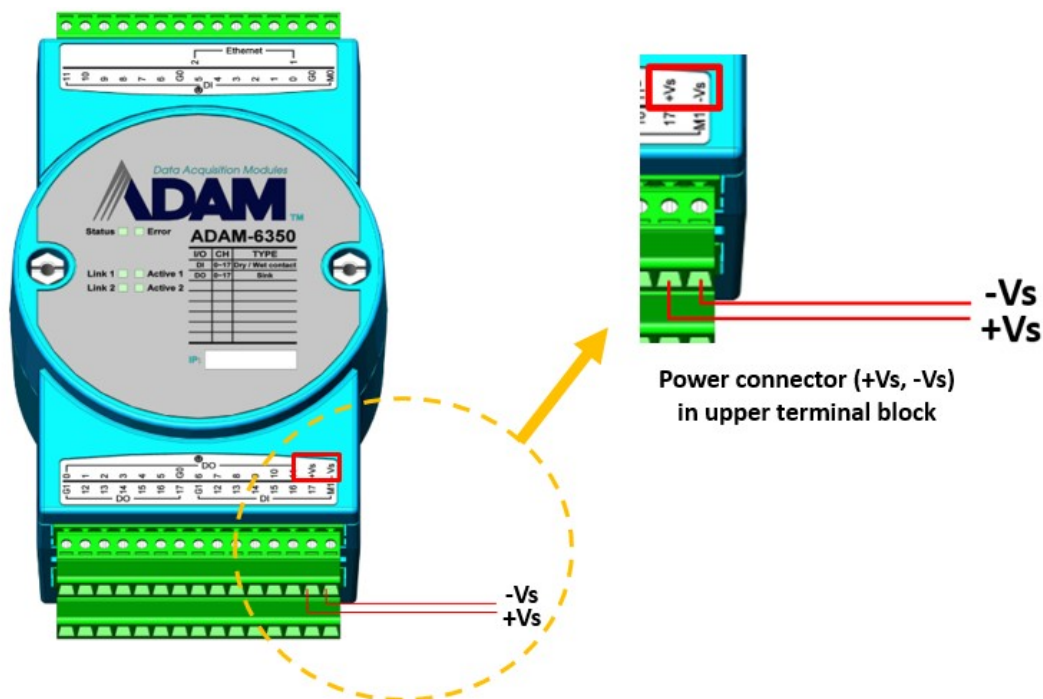

Figure 1.2 Power Connector

1.3.3 Ethernet Connector and Grounding Screw

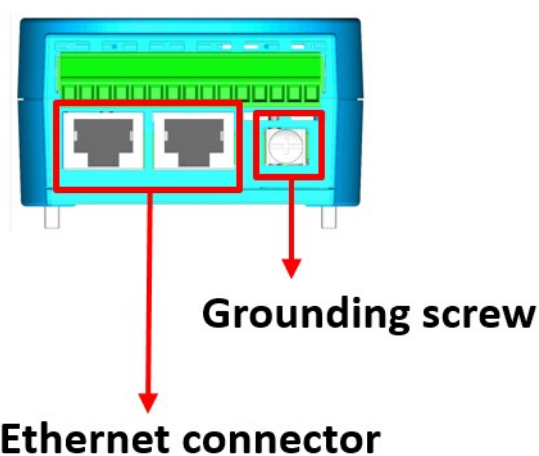

Figure 1.3 Ethernet Connector and Grounding Screw

1.3.4 LED Definition

The ADAM-6300 series are equipped with LED indicators that show the device status. The LED indicator behaviors are defined below.

LED	Color	Behavior	Definition
Status	Green	Flashing(1Hz)	Normal mode
		Flashing(10Hz)	Module is booting
Link1	Yellow	Stay on	Ethernet(Eth1) speed is connected
Link2	Yellow	Stay on	Ethernet(Eth2) speed is connected
Active1	Green	Flashing	Ethernet(Eth1) is transmitting/receiving data
Active2	Green	Flashing	Ethernet(Eth2) is transmitting/receiving data

The indicator behavior for Error LED light can be configured using ASCII command:
\$01ErrLEDs
\$01ErrLED0: Error light off
\$01ErrLED1: Error light stay on

1.3.5 Dimensions

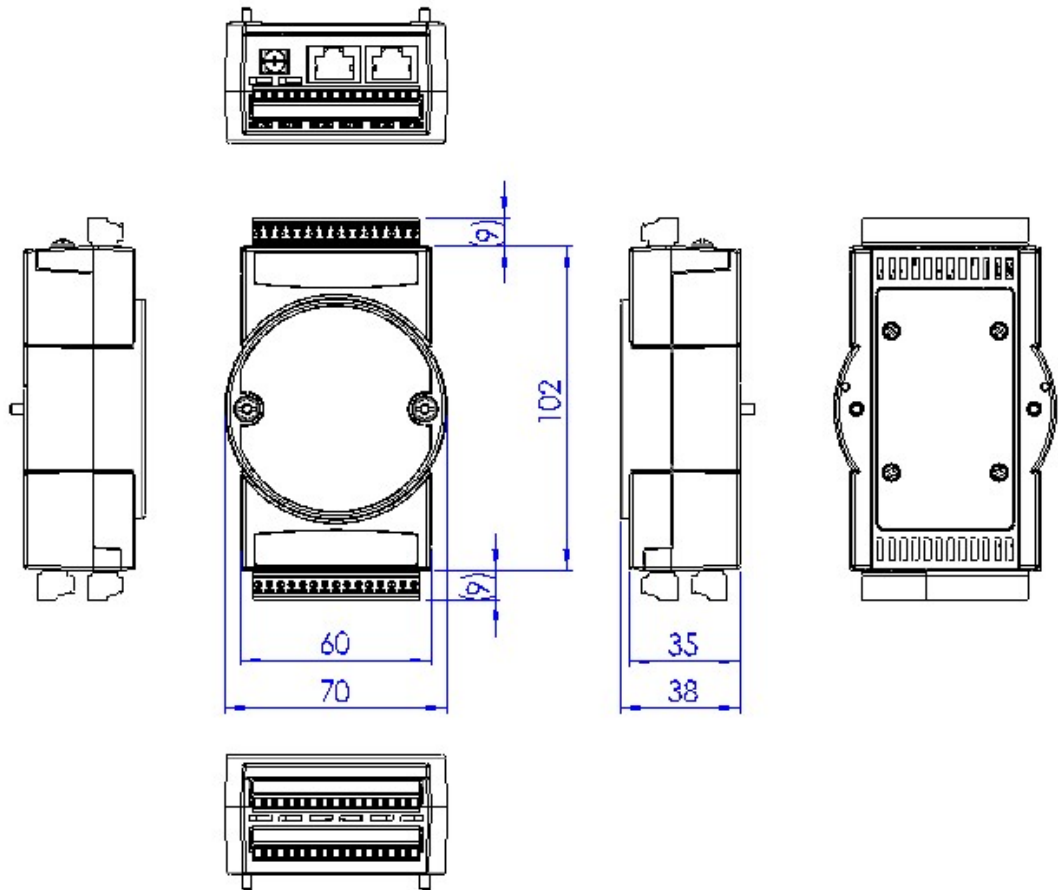

Figure 1.4 ADAM-6300 Dimensions

1.4 Package Information

- 1 x ADAM-6300 module
- 1 x ADAM-6300 quick start note
- 1 x Electronic information for pollution (China only)
- 1 x DIN rail mounting bracket

Chapter 2

Hardware Installation

2.1 Mounting: DIN rail

The ADAM-6300 module can be secured to a cabinet by using DIN rails. First, fix the ADAM-6300 module to the DIN rail adapter and then secure it on the DIN rail. When mounting the module on the rail, you should consider using end brackets at each end of the rail in order to prevent the module from sliding.

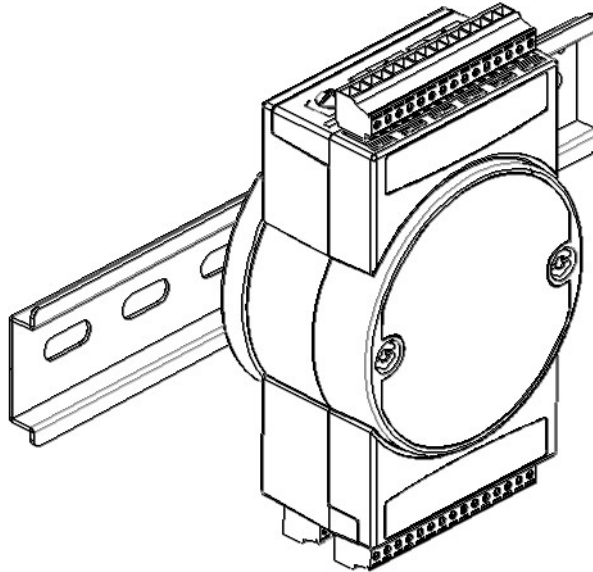

Figure 2.1 DIN Rail Adapter

2.2 Power Supply Wiring

The ADAM-6300 series is designed for a standard industrial unregulated 24 VDC power supply. For further applications, it can also accept +10 to 30 VDC.

Power supply ripple must be limited to 200 mV peak-to-peak, and the immediate ripple voltage should be maintained between +10 and 30 VDC. Screw terminals +Vs and GND are for wiring the power supply.

We advise using the following standard colors (which are also indicated on the modules) for the power lines: +Vs (R) Red GND (B) Black.

2.3 I/O Module Wiring

A plug-in screw terminal block is used for the interface between I/O modules and field devices. The following information must be considered when connecting electrical devices to I/O modules.

- The terminal block accepts Wire Size #16~28 AWG (stripped length: 6.5 mm)
- Always use a continuous length of wire; do not combine wires
- Use the shortest possible wire length
- Use wire trays for routing where possible
- Avoid running wires near high-energy wiring
- Avoid running input wiring proximal to output wiring
- Avoid creating sharp bends in the wires

Note! *The wires should be at least 2 mm in diameter.*



Chapter 3

Introduction to Digital
I/O

3.1 Specifications

3.1.1 General

- **Power input:** 10 ~ 30 V_{DC}
- **LAN:** 10/100Base-T(X)
- **Connectors:** 2 x RJ-45 (LAN), 1 MAC ID; Plug-in screw terminal block (I/O and power)
- **Screw terminal block:** Accepts wire size #16-28 AWG, stripped length: 6.5 mm
- **Watchdog:** System and Communication
- **Real-time clock accuracy:** 2 seconds per day
- **Certification:** CE, FCC

3.1.2 Protection

- Power Reversal Protection

3.1.3 Environment

- **Operating temperature:** -25 ~ 70 °C (-13 ~ 158 °F)
- **Storage temperature:** -40 ~ 85 °C (-40 ~ 185 °F)
- **Operating humidity:** 20 ~ 95% RH (non-condensing)
- **Storage humidity:** 0 ~ 95% RH (non-condensing)

3.1.4 OPC UA Specification

- Supports Address Space, Session, Monitored item, and Subscription

Items	Max	Remark
Max Monitored Items	600	Including all sessions
Max Sessions	4	The maximum sessions supported, including security and non security session.
Max Subscriptions per Session	1	

Note!  ADAM-6300 supports 4 session including security and non security sessions. User can disconnect sessions in Utility and remove sessions they don't need.

- Security Policy

An endpoint security policy is a predefined communication mode that mandates a combination of security algorithms and optionally message signing and encryption.

- Endpoint Security Policy: None
- Endpoint Security Policy: Sign - Basic128Rsa15

- Authentication Policy

- User Token Anonymous - Token Security Policy None
- User Token Username / Password - Token Security Policy Basic128Rsa15

- Supports 8 certificates

Note!  ADAM-6300 supports 8 certificates. Click **Delete Certificates** and ADAM-6300 will be automatically restart and then remove certificates that are not needed.

3.2 Digital Input/Output Modules (ADAM-6350)

The ADAM-6350 is a high-density I/O module with a built-in 10/100BASE-T interface for seamless Ethernet connectivity. The module has 18 digital inputs and 18 digital outputs with 2,500 VDC isolation protection. All inputs have a latch function for handling important signal handling, and they can be used as 3-kHz counter and frequency input channels (DI12~DI17). The outputs support 3 kHz Pulse Output (DO12~DO17).

3.2.1 Specifications

General

- **Power Consumption:** 4W @ 24 V_{DC}
- **Isolation:** 2,500 V_{DC}

Digital Input

- Channel: 18
- Dry contact: Logic 0: Open; Logic 1: Closed to DGND
- Wet contact: Logic 0: 0 ~ 3 V_{DC}, Logic 1: 10 ~ 30 V_{DC}
- DI12~DI17 Supports 3 kHz Counter Input
- DI12~DI17 Supports 3 kHz Frequency Input

Digital Output

- Channel: 18
- Type: Sink 30 V_{DC}, 0.1A max. per channel
- DO12~DO17 Supports 3 kHz Pulse Output

3.2.2 Application Wiring

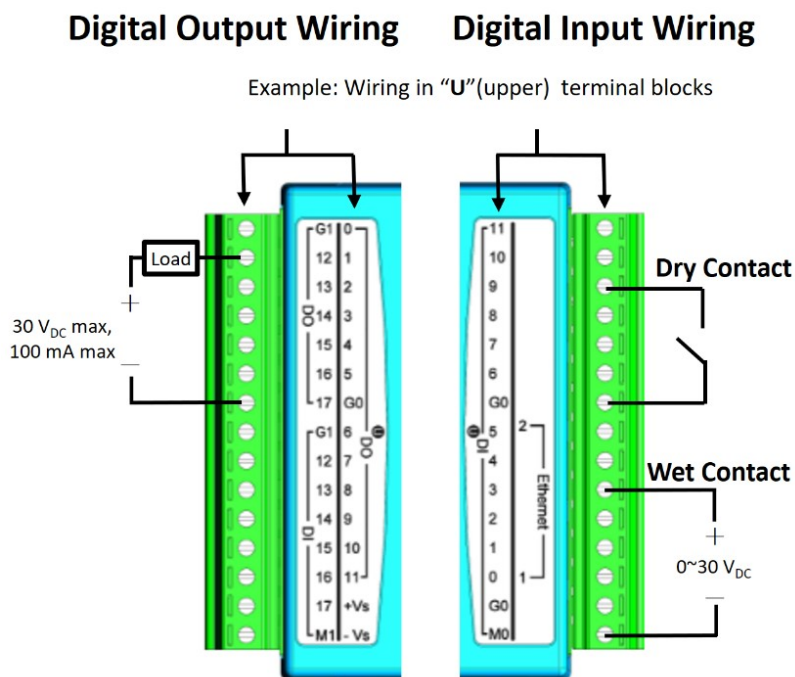

Figure 3.1 Application Wiring (Top View)

Example: Wiring in "U"(upper) terminal blocks

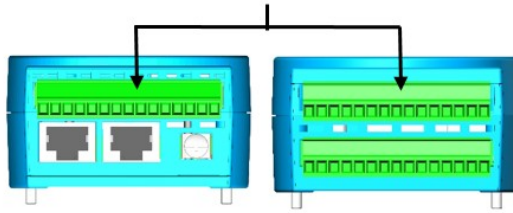

Figure 3.2 Application Wiring (Side View)

Note! It suggest that user use fly-diode when customer use inductive load.



ADAM-6300
DI/O Modules

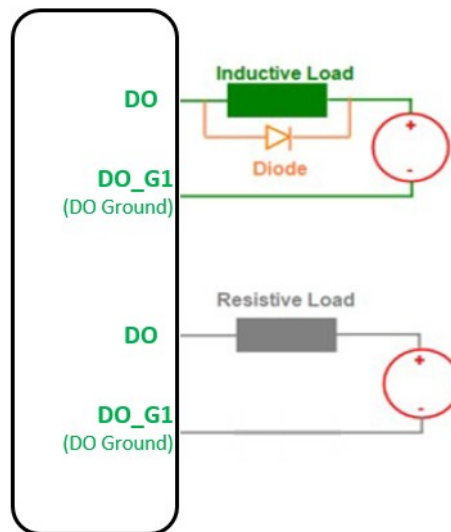

Figure 3.3 DO Output Wiring (Resistive and inductive load)

3.3 Analog Input Modules (ADAM-6317)

The ADAM-6317 is a high-density I/O module with a built-in 10/100BASE-T interface for seamless Ethernet connectivity. The module has 8 analog input, 11 digital inputs and 10 digital outputs with 2,500 VDC isolation protection.

3.3.1 Specifications

Analog Input

- Channels: 8 (differential)
- Sampling Rate: 10 or 100 samples/ second (total)
- Resolution: 16 bits
- Input Range: 0 ~ 150 mV, 0 ~ 500 mV, 0 ~ 1 V, 0 ~ 5 V, 0 ~ 10 V, ± 150 mV, ± 500 mV, ± 1 V, ± 5 V, ± 10 V, ± 20 mA, 0 ~ 20 mA, 4 ~ 20 mA

Digital Input

- Channel: 11
- Dry contact: Logic 0: Open; Logic 1: Closed to DGND
- Wet contact: Logic 0: 0 ~ 3 V_{DC}, Logic 1: 10 ~ 30 V_{DC}
- DI5~DI10 supports 3 kHz Counter Input
- DI5~DI10 supports 3 kHz Frequency Input

Digital Output

- Channel: 10
- Type: Sink 30 V_{DC}, 0.1A max. per channel
- DO4~DO9 supports 3 kHz Pulse Output

3.3.2 Application Wiring

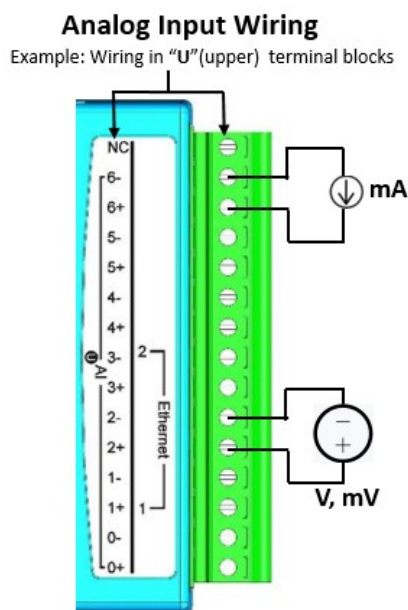

Figure 3.4 Analog Input Wiring

Digital Input Wiring

Example: Wiring in "bottom" terminal blocks

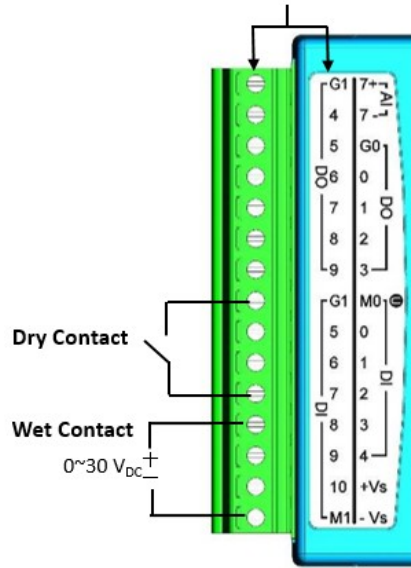

Figure 3.5 Digital Input Wiring

Digital Output Wiring

Example: Wiring in "bottom" terminal blocks

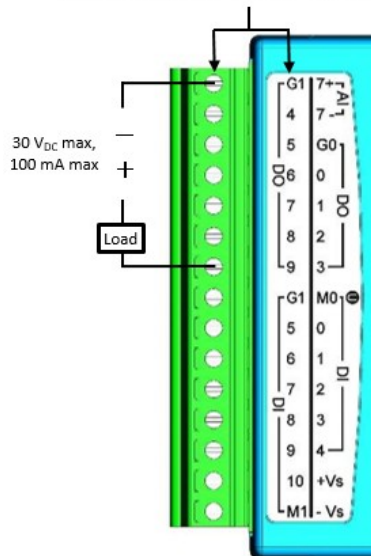
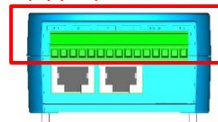

Figure 3.6 Digital Output Wiring

Ⓢ "U"(upper) Terminal Block



Ⓢ "U"(upper) Terminal Block



Bottom Terminal Block

Figure 3.7 "U"(Upper) and Bottom Terminal Block

3.4 SSR Relay Output Module Modules (ADAM-6360D)

The ADAM-6360D is a high-density I/O module with a built-in 10/100BASE-T interface for seamless Ethernet connectivity. The module has 8 SSR (Solid-State Relay) relay output, 14 digital inputs and 6 digital outputs with 2,500 VDC isolation protection.

3.4.1 Specifications

SSR (Solid-State Relay) Relay Output (PhotoMOS SPST)

- Channels: 8 (Form A)
- Contact rating (Resistive and Inductive load):
1 A @25°C@30 V_{DC}
0.7A @70°C@30 V_{DC}
- Relay-on time: 1.3 ms
- Relay-off time: 0.8 ms
- Isolation (Relay output to power): 1500 Vrms
- Peak Load Current: 4 A (100 ms (1 pulse))
- Total Power Dissipation: 400 mW / channel
- On-state resistance: 0.5 Ω

Digital Input

- Channel: 14
- Dry contact: Logic 0: Open; Logic 1: Closed to DGND
- Wet contact: Logic 0: 0 ~ 3 V_{DC}, Logic 1: 10 ~ 30 V_{DC}
- DI8~DI13 Supports 3 kHz Counter Input
- DI8~DI13 Supports 3 kHz Frequency Input

Digital Output

- Channel: 6
- Type: Sink 30 VDC, 0.1A max. per channel
- DO0~DO5 Supports 3 kHz Pulse Output

3.4.2 Application Wiring

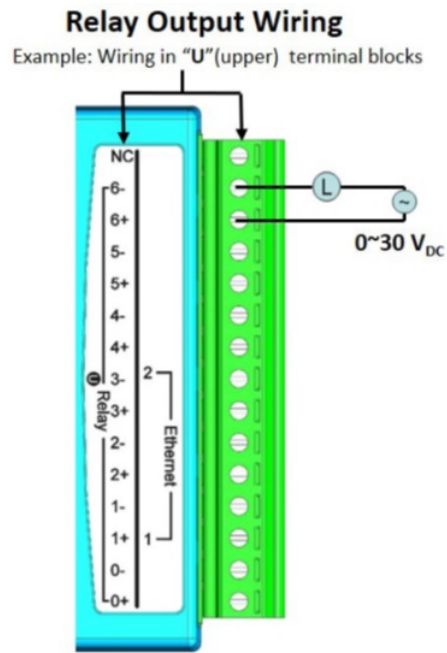

Figure 3.8 Relay Output Wiring

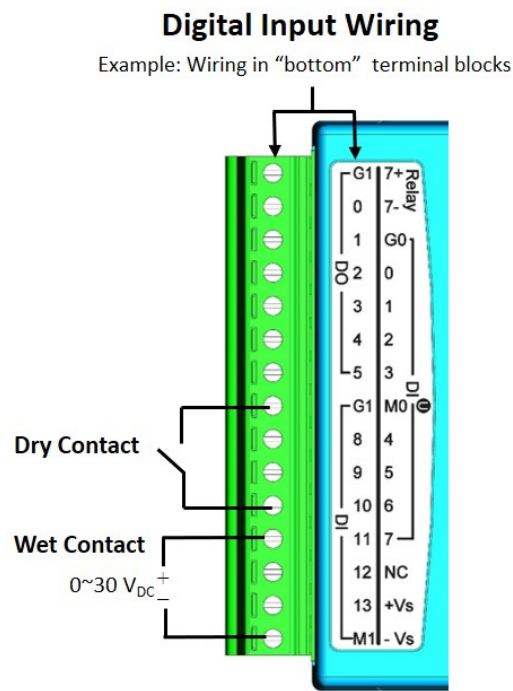

Figure 3.9 Digital Input Wiring

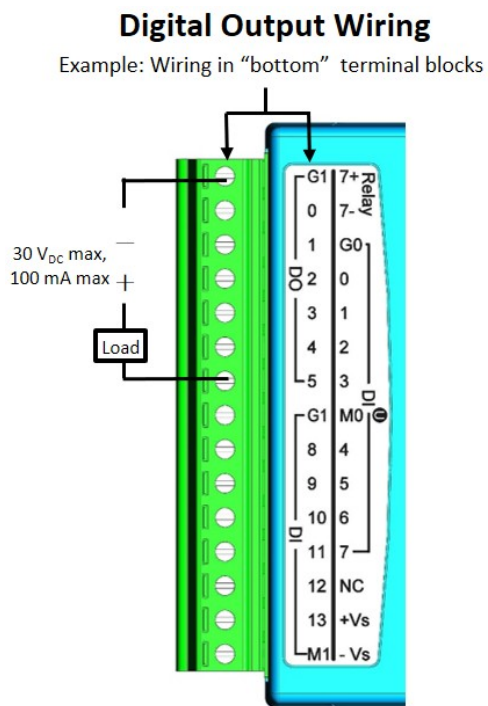

Figure 3.10 Digital Output Wiring

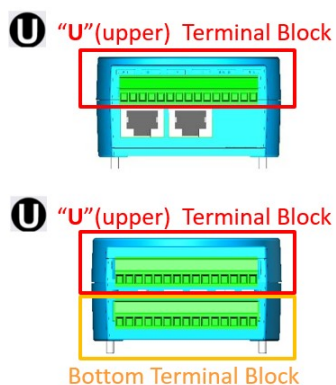

Figure 3.11 U (Upper) and Bottom Terminal Block

3.5 Relay Output Module Modules (ADAM-6366)

The ADAM-6366 is a high-density I/O module with a built-in 10/100BASE-T interface for seamless Ethernet connectivity. The module has 6 relay output, 18 x digital inputs and 6 x digital outputs with 2,500 VDC isolation protection.

3.5.1 Specifications

Relay Output

- Channels: 6 (Form A)
- Contact rating (Resistive):
 - 0.25A@250VAC
 - 2A@30VDC
- Relay-on time: 3 ms
- Relay-off time: 5 ms
- Electrical endurance at contact application
 - Resistive, 0.25A@250VAC: 1×10^5 operations/min.
 - Resistive, 2A@30VDC: 1×10^5 operations/min.
- Insulation Resistance: 1 G Ω

Digital Input

- Channel: 18
- Dry contact: Logic 0: Open; Logic 1: Closed to DGND
- Wet contact: Logic 0: 0 ~ 3 VDC, Logic 1: 10 ~ 30 VDC
- DI12~DI17 Supports 3 kHz Counter Input
- DI12~DI17 Supports 3 kHz Frequency Input

Digital Output

- Channel: 6
- Type: Sink 30 VDC, 0.1A max. per channel
- Supports 3 kHz Pulse Output

3.5.2 Application Wiring

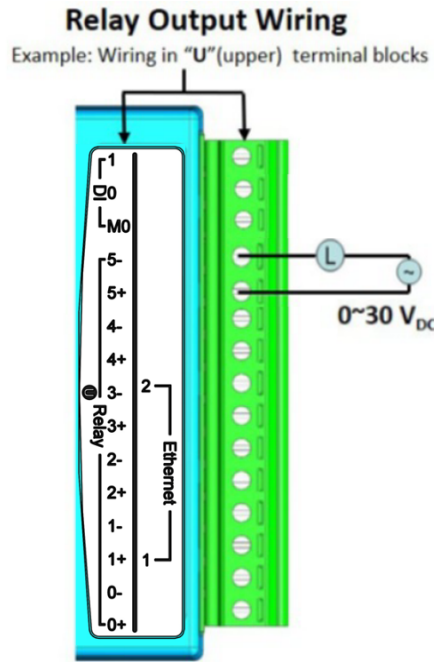

Figure 3.12 Relay Output Wiring

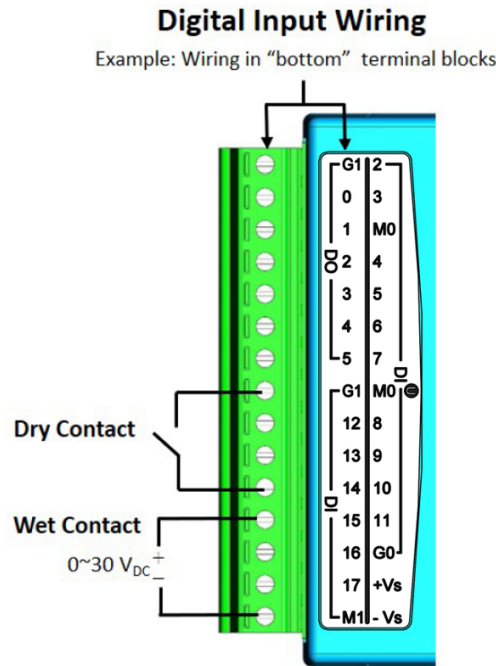

Figure 3.13 Digital Input Wiring

Digital Output Wiring

Example: Wiring in "bottom" terminal blocks

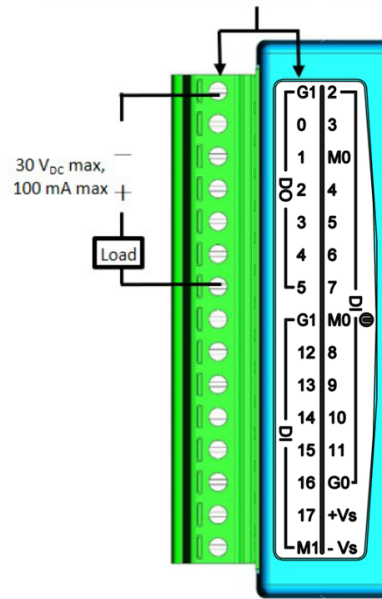

Figure 3.14 Digital Output Wiring

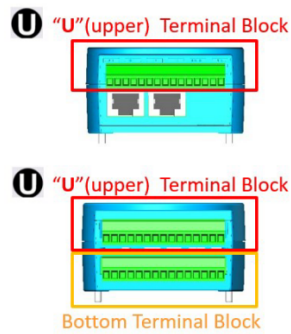

Figure 3.15 U (Upper) and Bottom Terminal Block

Chapter 4

System Configuration

4.1 System Requirements

Host Computer

- Microsoft Windows 7 or above
- 64 MB RAM
- 100 MB free hard disk space
- Mouse or other pointing device
- 10/100-Mbps Ethernet Card

4.2 Installing Adam/Apax .NET Utility

Adam/Apax .NET Utility is an application provided by Advantech for the configuration and operation of ADAM modules. The installation file is available for free download at <http://www.advantech.com> (click on Download Area under Service & Support for the latest version). Once installed, a shortcut to the utility will appear on your desktop.

Note! *Before installing Adam/Apax .NET Utility, you will need to install .NET Framework 4.5.1 or later.*



4.3 Adam/Apax .NET Utility Overview

Adam/Apax .NET Utility is a graphical interface for configuring and operating ADAM modules. The following text instructions describe how to use the utility.

To start Adam/Apax .NET Utility, double-click the shortcut on the desktop or click the icon in the start menu folder. When the program is first opened, the main window will appear as shown in Figure 4.1.

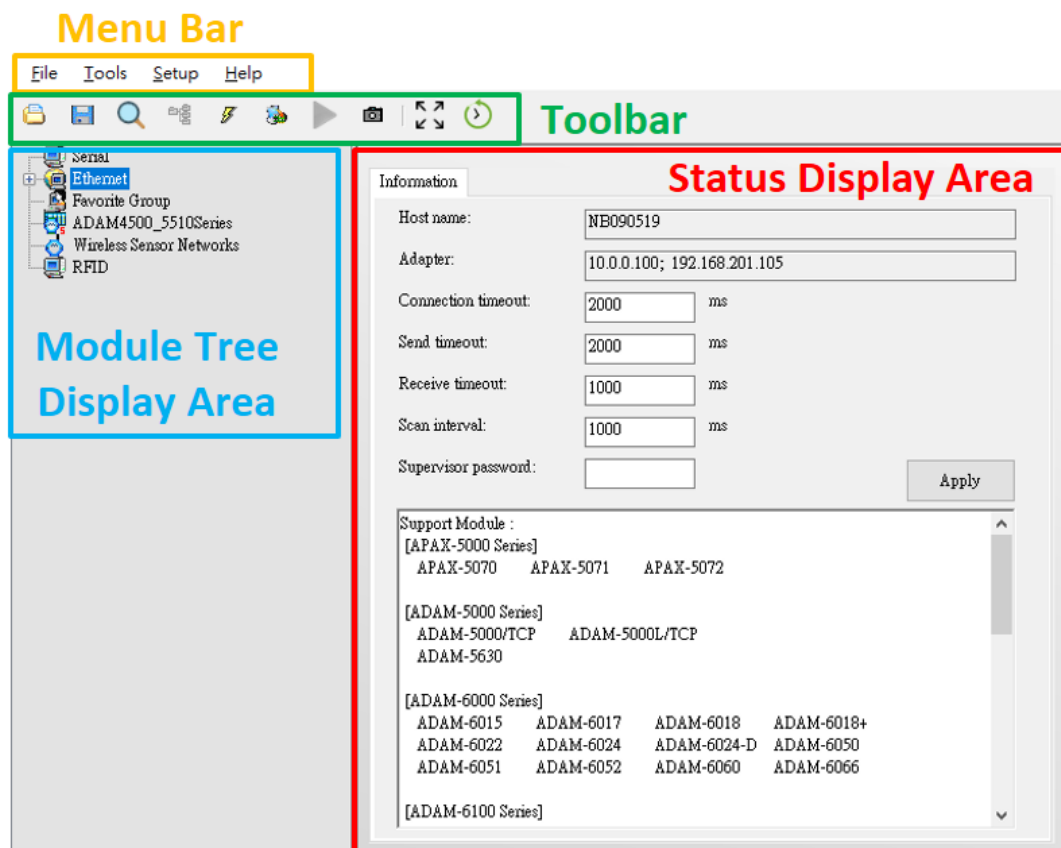

Figure 4.1 Adam/Apax .NET Utility Operation Window

As shown in the figure, this window has four main areas: 1) the Menu Bar, 2) the Toolbar, 3) the Module Tree Display Area, and 4) the Status Display Area.

4.3.1 Menu Bar

The menu bar comprises four menus: File, Tools, Setup, and Help. The items under each menu are described as follows:

File Menu

Open Favorite Group	Allows you to load a saved configuration file for a favorite group.
Save Favorite Group	Allows you to save a favorite group into a configuration file.
Auto-Initial Group	Checking this option will load the same favorite group configuration next time you launch Adam/Apax .NET Utility.
Exit	Exit Adam/Apax .NET Utility.

Tools Menu

Search Device	Search for all ADAM modules connected to the host PC.
Add Devices to Group	Adds ADAM modules to the favorite group; only selected devices in the Module Tree Display Area will be added to the group.
Group Configuration	This item is for updating the firmware, configuration, and HTML files of a single module or multiple modules. The configuration file includes settings on device information, general information, P2P and streaming, GCL, and Modbus address XML files. The configuration file can be exported as a Cfg file from the Firmware tab in the Status Display Area.
Terminal for Command Testing	Launches a terminal for communicating with ADAM modules via ASCII command and Modbus/TCP.
Print Screen	Exports the Adam/Apax .NET Utility screen as an image file
Monitor Stream/Event Data	ADAM modules support a datastream function. This allows you to define the host (such as a PC) by IP, and ADAM modules will then periodically transmit their I/O status to the host. The IP address and transmission period can be configured from the Stream tab in the Status Display Area.

Setup Menu

Favorite Group	This is for configuring your Favorite group, including adding devices, modifying or deleting current devices, sorting current devices, and diagnosing device connections.
Refresh Serial and Ethernet	This will cause Adam/Apax .NET Utility to refresh the serial and LAN network connection.
Add COM Ports	This is for adding serial COM ports to Adam/Apax .NET Utility (this does not apply to ADAM-6000 modules).
Show TreeView	Clicking on this item shows the Module Tree Display Area.
Allow Calibration	Select this to enable/disable module calibration.

Help Menu

Check Up-to-Date on the Web	Connect to the Advantech download website and checks for the latest version of the utility.
About	This shows information on the version of Adam/Apax .NET Utility currently installed on your computer.

4.3.2 Toolbar

The toolbar contains icons for the most commonly used menu items.

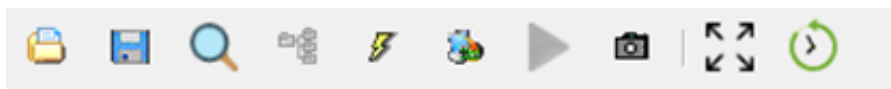

Figure 4.2 Adam/Apax .NET Utility Toolbar

From left to right icon are:

1. Open favorite group
2. Save favorite group
3. Search Modules
4. Add Devices to Group
5. Terminal for Command Testing
6. Group Configuration
7. Monitor Data Stream/Event
8. Print Screen
9. Adjust the size of toolbar
10. NTP

Click NTP icon and click **Start** to start the NTP process. Adam/Apax .NET Utility uses NTP broadcasting packet to module for time synchronization.

Note: User must select one Ethernet interface before click NTP icon.

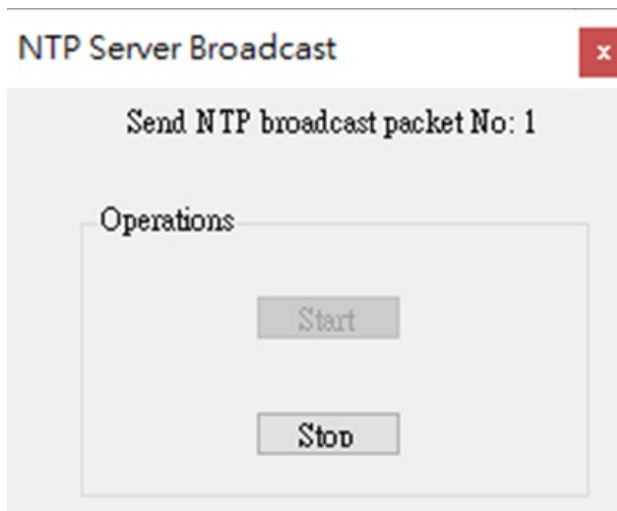

4.3.3 Module Tree Display Area

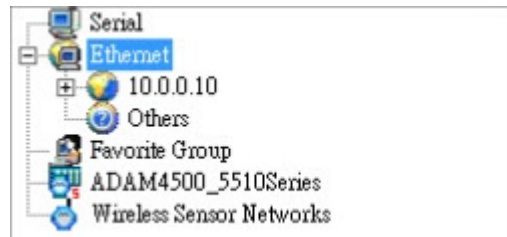

Figure 4.3 Adam/Apax .NET Utility Module Display Area

The Module Tree Display Area is the left part of the main window. There are five major categories in the display area, some of which will be visible only when you have certain modules connected:

Serial	All serial I/O modules (ADAM-4000, ADAM-4100, and ADAM-5000 RS-485 modules) connected to the host PC will be listed in this category.
Ethernet	All Ethernet I/O Modules (ADAM-5000, ADAM-6000, and ADAM-6100 TCP modules) connected to the host PC will be listed in this category.
Favorite Group	Devices you have added to your personal favorite group are listed under this category, making it easier for you to locate specific modules. The favorite group can contain multiple groups. To create a new group, right-click on Favorite Group and select Add New Group . You will then be prompted to enter a name for the group. To add devices to that group, right-click on the group you have created and select Add New Device . You will then be prompted to give the new device a name and select the module type from either the Serial Device tab or the Ethernet Device tab. You can also enter the device parameters here. In addition to modifying the group (select Modify Group) and deleting the group (select Delete Group), you can also select diagnose the connection for a group (select Diagnose Connection) by right-clicking on the group name.
ADAM-4500_5510Series	Any DOS-based remote controllers (e.g., ADAM-4500 and ADAM-5510 series) will be listed under this category.

4.3.4 Status Display Area

The Status Display Area is the main window that you will interact with. All configuration and testing is performed here. The content of this window will vary depending on which items you select in the Module Tree Display Area.

4.4 Configuration of ADAM-6300 Modules

Once an ADAM-6300 module has been connected to the host PC and you have searched for it, you will find it listed in the Module Tree Display Area under the Ethernet category. Select the Ethernet category on the Module Tree Display Area and click the Search Modules icon on the Toolbar. Adam/Apax .NET Utility will then search for all ADAM-6300 modules on the Ethernet network. If this is the first time you have connected the module, its IP will be 10.0.0.1 by default and it will appear under others in the Module Tree Display Area.

Note! *If a network firewall is enabled, you might not be able to connect to your ADAM-6300 module. You may need to add an exception for Adam/Apax .NET Utility in Windows Firewall via Windows Control Panel.*



Note! *The default password is 00000000.*

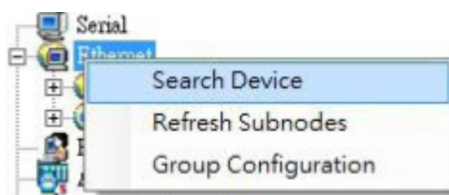

You need to change the IP address of the ADAM-6300 module so that it is the same subnet as the host PC. Enter the correct IP address, subnet address, and default gateway on the Status Display Area and then click Apply Change. A dialog box will appear asking you to enter the password. The default password of ADAM-6300 modules is "00000000" (without quotation marks). After you have entered the correct password, the ADAM-6300 module will be under IP of your host PC. Note that you can change the password later.

When you select the IP address of the ADAM-6300 modules you want to use in Module Tree Display Area, tabs will become available in the Status Display Area. These tabs are for the general configuration of that module. Once you have changed any settings, remember to click Apply or Apply Change. These tabs are detailed in the following sections.

4.4.1 The Information Tab

The screenshot shows the 'Information' tab selected. It contains the following fields and controls:

- Firmware Version: 1.10 B03
- IO Version: A1.01 B005
- Device Name: ADAM-6350-Alvin5
- Device: (Empty text area)
- Apply button
- Description table:

Slot	Module	Description
	6350	ADAM-6350 OPCUA module

This tab shows the firmware version as well as the device name and device description, both of which can be modified from here. Giving your modules a specific name and description can be useful for when several ADAM-6300 modules are connected to the same network.

Firmware Version

Indicates the current Firmware version of ADAM-6300 module.

Device Name

Means model name of ADAM-6300 module. You also can rename it for recognition if required.

Device Description

You can add comments on this module for recognition.

4.4.2 The Network Tab

The screenshot shows the 'Network' tab selected. It contains the following fields and controls:

- Network Setting
- MAC Address: 00-D0-C9-FE-EE-FC
- IP Address: 10.0.0.3
- Subnet Address: 255.255.255.0
- Default Gateway: 0.0.0.0
- Apply button

You can set up required network connection on this page.

Network Setting

You can configure the IP address, Subnet address, Default gateway.

Note! Static IP mode is set to 10.0.0.1 as default.



4.4.3 The Administration Tab

Note! The default password is "00000000".



The **Administration** tab allows you to set the password for the selected ADAM-6300 modules. To change the password, you will need to enter the current password in the Old password box and then enter the new password in the New password and Verify password boxes. The password is required for many configurations and operations, so setting your own password can help ensure system security.

4.4.4 The Firmware Tab

Advantech will occasionally release new firmware versions to add or improve the functionality of ADAM-6300 modules. Visit <http://www.advantech.com> to check for the latest firmware downloads. User can download System or IO Firmware file (Bin).

This is where you can import firmware to your ADAM-6000 module. Click Browse to select the firmware file on your computer. Then, click Download to install the new firmware on the ADAM-6300 module.

4.5 Getting started: The Connection of OPC UA Server and Client

You can refer below flowchart of getting start guide, the connection of OPC UA Server (ADAM-6300) and Client (Adam/Apax .NET Utility).

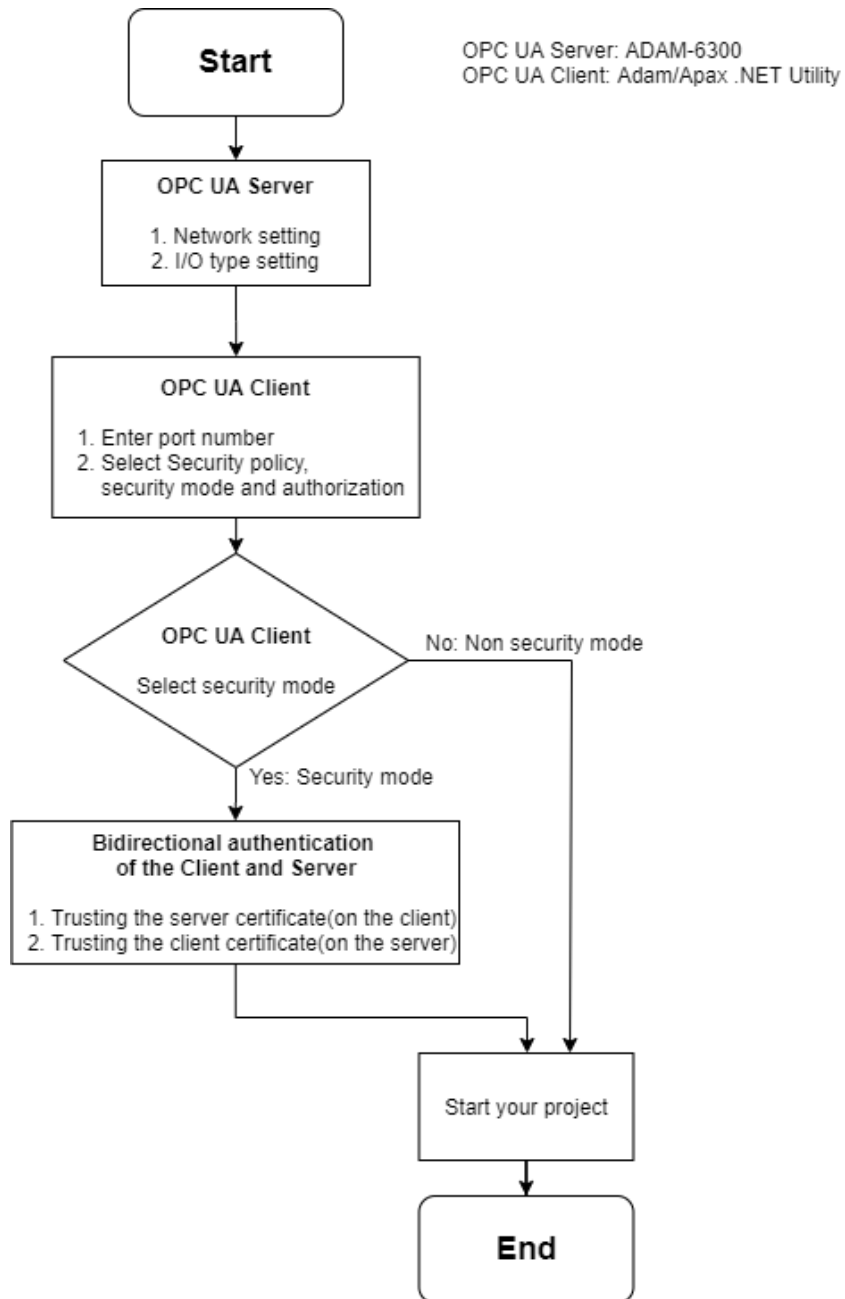

Figure 4.4 Flowchart for getting started guide, the connection of OPC UA Server (ADAM-6300) and Client (Adam/Apax .NET Utility)

4.5.1 Network and I/O type setting

4.5.1.1 Network setting

1. Connect the module to your PC and execute **Adam/Apax .NET Utility** from your desktop or start menu.

- In the Module Tree Display Area, right-click on the Ethernet group and click **Search Device**.

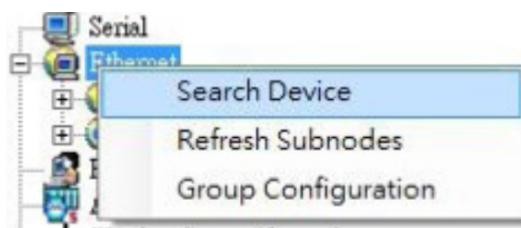

- If you see the module under the **Others** group, you need to change the IP address of the ADAM-6300 module so that it is the same subnet as the host PC. Enter the correct IP address, subnet address, and default gateway on the Status Display Area and then click **Apply Change**.

Please input password, default password is 00000000.

The module should now appear under your network domain and will be ready for configuration.

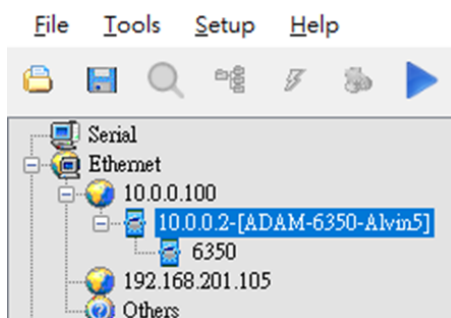
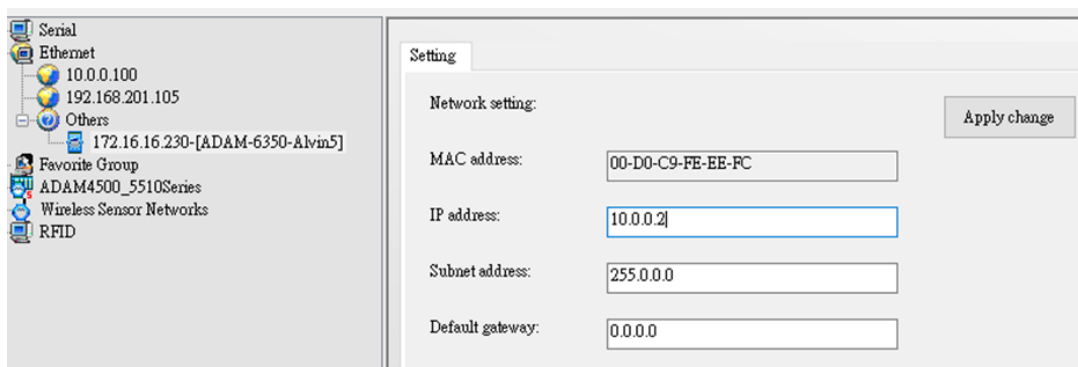

4.5.1.2 I/O type setting

Refer to the Module Tree Display Area shown. When you click on the IP address of the ADAM-6300 module you wish to configure, you will see items below the IP address. When you click on the plus and minus control beside the module number, you will be prompted to enter the password for the selected module. Once you have entered the correct password, a list of individual channels (for individual channel configuration) will appear below the module number.

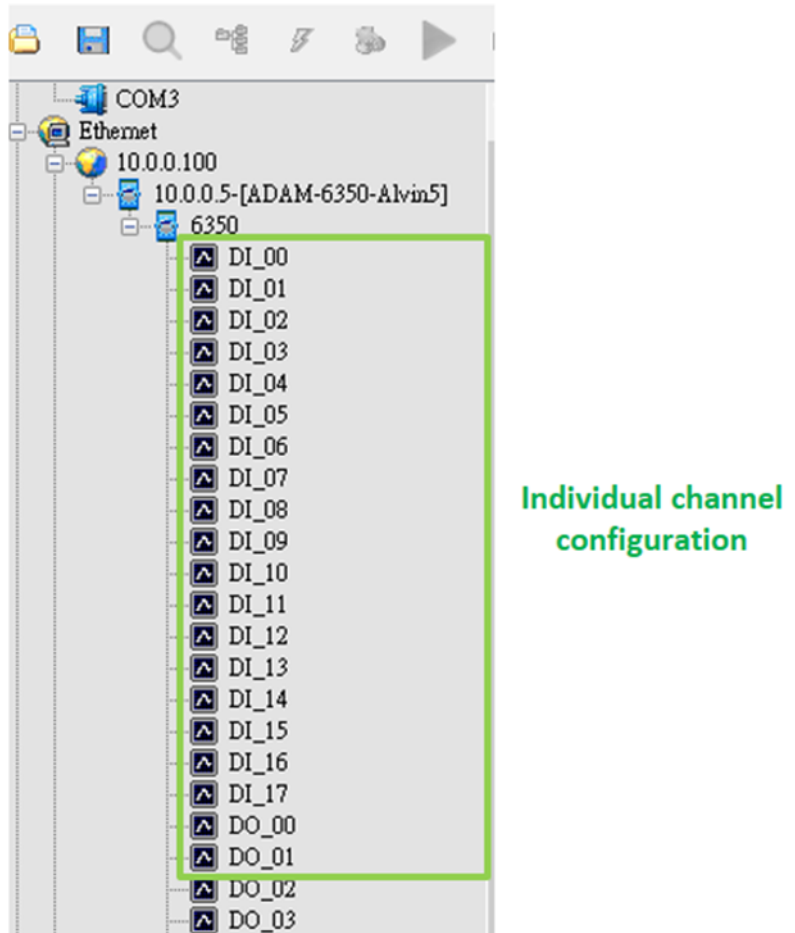

When you click on one of the individual channel items, you can select I/O type mode and click **Apply mode** for this channel or click **Apply to CH12~17** for channel 12~17.

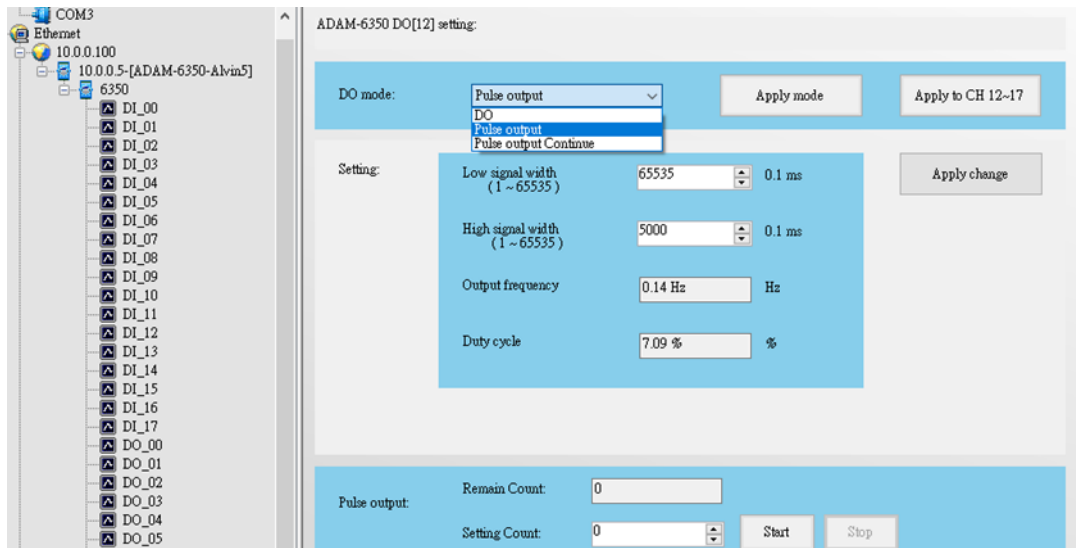

4.5.2 Connection of OPC UA Server and OPC UA Client

4.5.2.1 Enter port number (OPC UA Client)

EndPoint URL (opc.tcp://10.0.0.5:4840) has been set in default setting of Adam/Apax .NET Utility. Enter 4840 in Port Number if you use other OPC UA client.

The screenshot shows the OPC UA configuration window with the following details:

- Tab: OPCUA
- EndPoint URL:
- Enable Security:
- Buttons: Connect, Disconnect
- Address Space: (Empty table)
- Attributes: (Table with columns: Name, Value, Data Type)

4.5.2.2 Select Security policy, security mode and authorization

ADAM-6300 supports two security options of sessions(OPC UA client). One is Basic128Rsa15 – Sign and the other is non security session.

1. Select security mode
 - A. Click **Enable Security** and click **Connect**, the dialogue window shown, enter root in **Username** and **Password** (default password is 00000000) and click **OK**.

The screenshot shows the OPC UA configuration window with the following details:

- Tab: OPCUA
- EndPoint URL:
- Enable Security:
- Buttons: Connect, Disconnect
- Address Space: (Empty table)
- Attributes: (Table with columns: Name, Value, Data Type)
- Data Access View: (Table with columns: No., ID)

The 'OPCUA User Security Check' dialog box is open with the following details:

- Security Policy URI:
- User Name:
- Password:
- Buttons: OK, Cancel

- B. The log window shows “BadSecureChannelClosed”, since OPC UA client and server need to have bidirectional authentication at first connection.

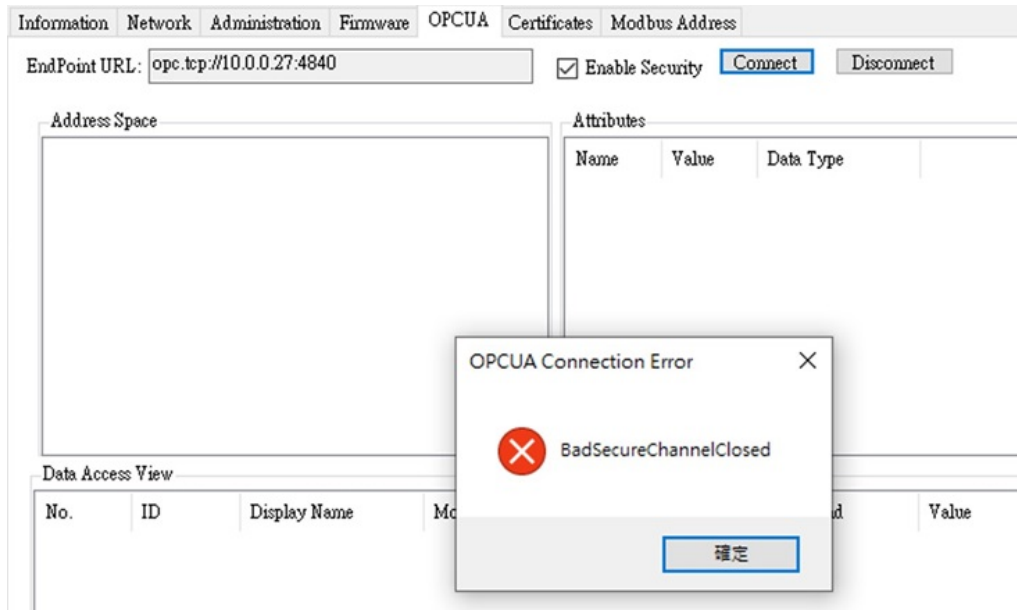

- C. Go to Certificate tab for bidirectional authentication.

- a. Trusting the OPC UA Sever's certificate (on the OPC UA Client): Adam/ Apax .NET Utility automatically trusts ADAM-6300 (sever) certificate. **Name of Local certificate list** will show the Adam/Apax .NET Utility's certificate.



- b. To Trust the OPC UA Client's certificate: Please click **Trust Certificate** in ADAM tab, and ADAM-6300 module will be automatically restarted to make certification take effect. You will then see **Trusted** in the status of the ADAM Client Certificate List.

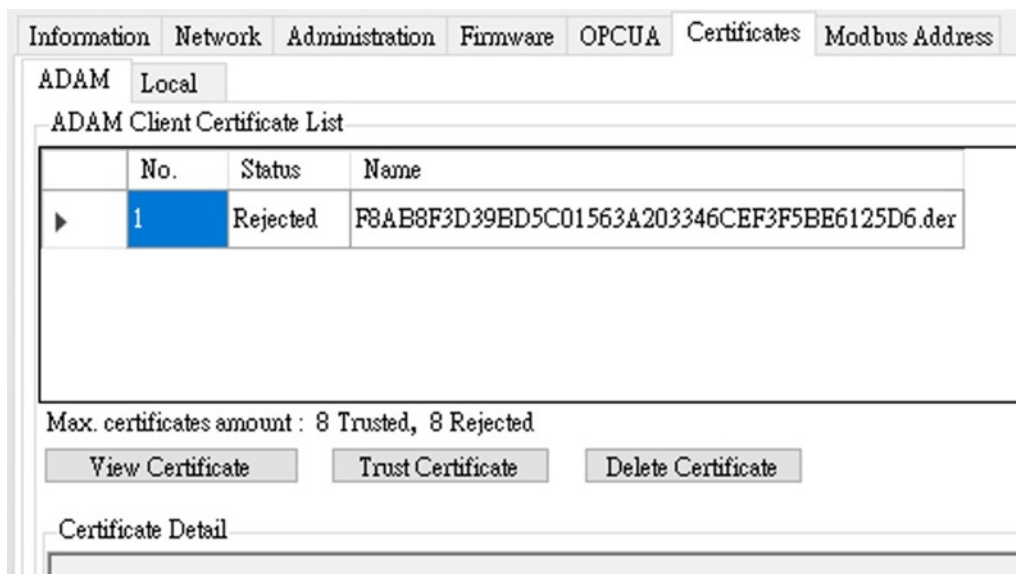

Please click **Trust Certificate** to trust a client's certificate.

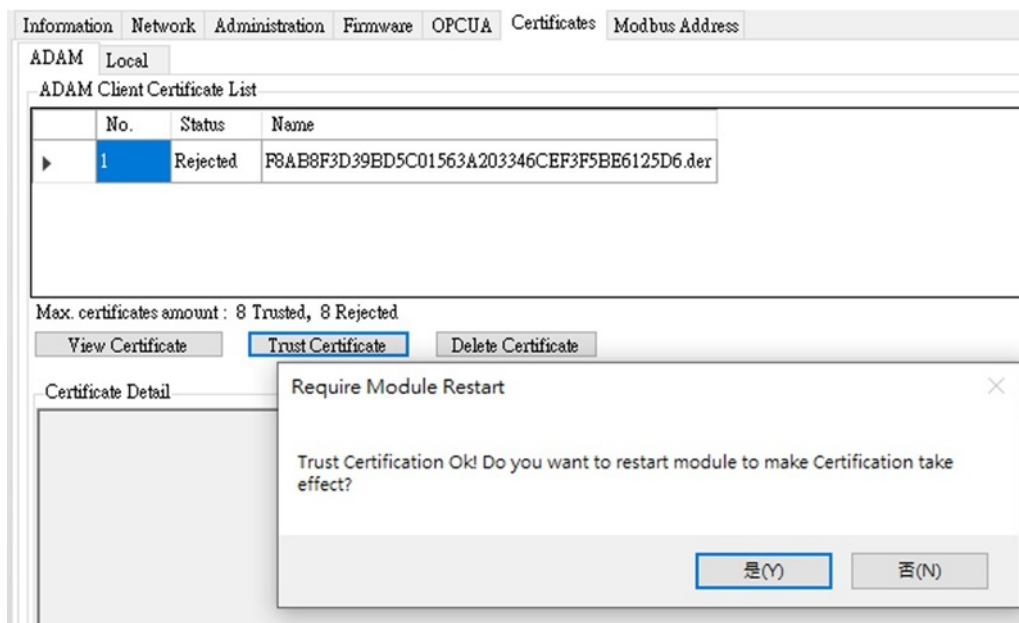

This certificate of status was changed to **Trusted**.

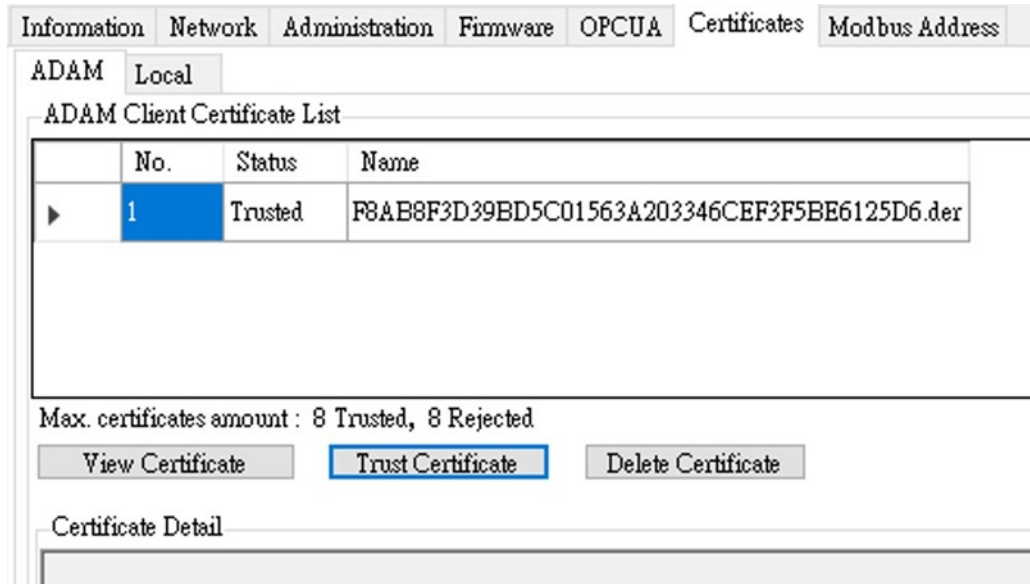

Note! ADAM-6300 supports 8 trusted certificates. User can click **Delete Certificate** and ADAM-6300 module will be automatically start to remove certificates you don't needed.

- D. Go to **OPC UA** tab to connect this session of OPC UA server and client again. Click **Enable Security** and click **Connect**, the dialogue window shown, enter root in **Username** and **Password** (default password is 00000000) and click OK.

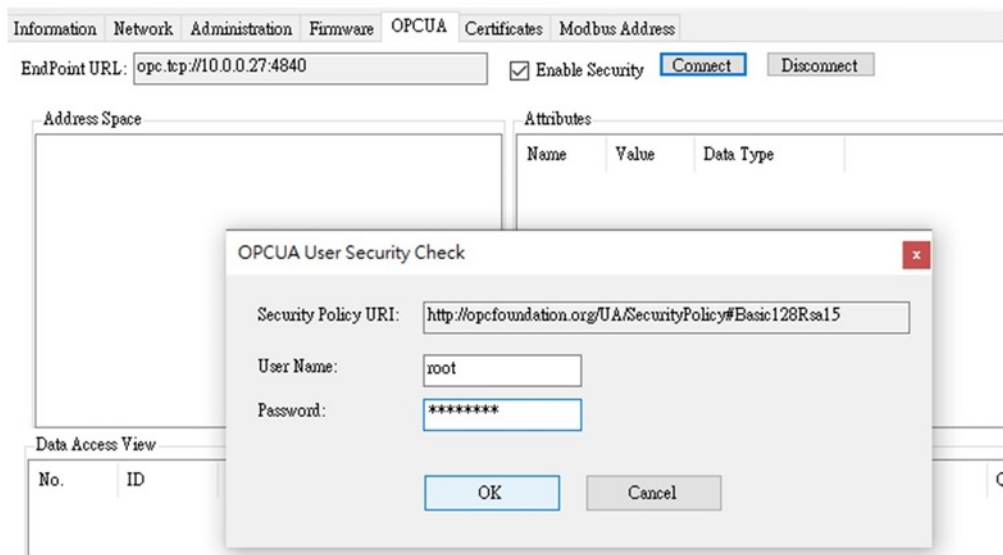

- E. The connection of ADAM-6300 modules and Adam/Apax .NET Utility (OPC UA client) is successful. **OPC UA** tab includes **Address Space**, **Attributes**, **Data Access View**.
- **Address Space**: to provide a standard way for the OPC UA Server to represent objects to the OPC UA Client. Address space is constructed of nodes and references. Nodes contain attributes and properties, and nodes are in the address space.

- **Attributes:** the information that presents value of a variable, the read and write permissions of the variable, a textual description of the variable for node.
- **Data Access View:** to monitor changes of node's attributes
- **Subscriptions and Monitored Items:** User establishes subscription in OPC UA server to monitor the value of monitored items over a periodic time.

F. Start your OPC UA project now

The screenshot shows the OPC UA configuration window with the 'Connect' button highlighted. The 'Enable Security' checkbox is checked. The 'Address Space' tree shows 'Digital_Output' selected. The 'Attributes' table is visible below.

Name	Value	Data Type
NodeId	ns=1,urn=ObjectsFolder/Digital_Output	NodeId
NodeClass	Object	Int32
BrowseName	1:Digital_Output	QualifiedName
DisplayName	Digital_Output	Localized Text
Description		Localized Text
WriteMask	0	UInt32
UserWriteMask	0	UInt32
EventNotifier	None	Byte

2. Select non security mode
 - A. Click **Connect** in OPC UA tab

The screenshot shows the OPC UA configuration window with the 'Connect' button highlighted. The 'Enable Security' checkbox is unchecked. The 'Address Space' and 'Attributes' sections are empty.

- B. OPC UA tab will show Address Space, Attributes, Data Access View.

The screenshot shows the OPC UA configuration window with the 'Connect' button highlighted. The 'Enable Security' checkbox is checked. The 'Address Space' tree shows 'Digital_Output' selected. The 'Attributes' table is visible below.

Name	Value	Data Type
NodeId	ns=1,urn=ObjectsFolder/Digital_Output	NodeId
NodeClass	Object	Int32
BrowseName	1:Digital_Output	QualifiedName
DisplayName	Digital_Output	Localized Text
Description		Localized Text
WriteMask	0	UInt32
UserWriteMask	0	UInt32
EventNotifier	None	Byte

- C. You can start your OPC UA project now.

4.6 I/O Configuration

See the below table for I/O channel of ADAM-6300 series.

Model	Analog Input	Digital Input		Digital Output		SSR / Relay
		Support DI mode	Support DI, counter and frequency mode	Support DO mode	Support DO, pulse output, pulse output continue mode	
ADAM-6317	AI0~AI7	DI0~DI4	DI5~DI10	DO0~DO3	DO4~DO9	N/A
ADAM-6350	N/A	DI0~DI11	DI12~DI17	DO0~DO11	DO12~DO17	N/A
ADAM-6360D	N/A	DI0~DI7	DI8~DI13	N/A	DO0~DO5	SSR 0~7
ADAM-6366	N/A	DI0~DI11	DI12~DI17	N/A	DO0~DO5	Relay 0~5

4.6.1 Analog Input

4.6.1.1 All Channel Configuration

1. Integration Time:

To remove noise from the power supply, analog input modules of ADAM-6300 series feature a built-in filter (50 and 60 Hz). Follow these steps.

 - A. Select **AI_IntegrationTime** and right click **Write**

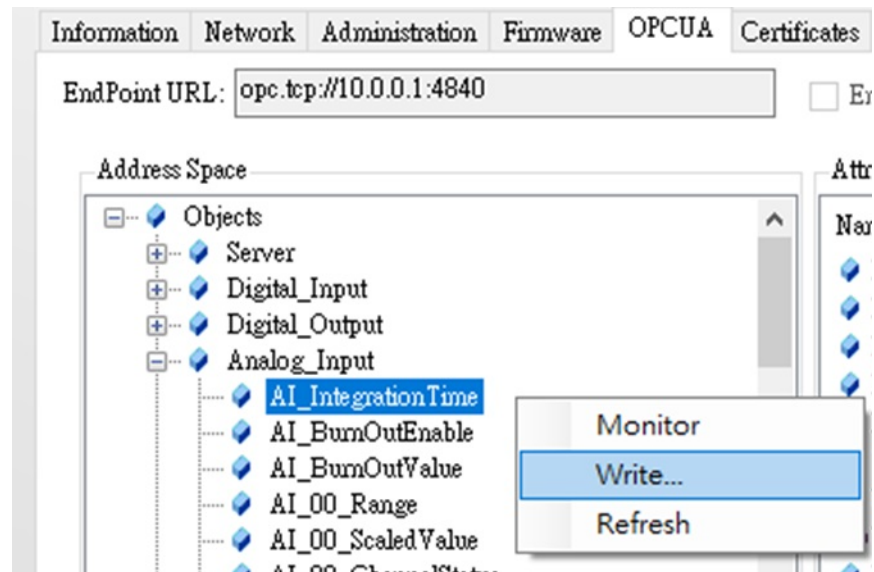

- B. Enter below value to choose 50/60Hz or High speed.
 - a. 0: 50/60Hz
 - b. 1: High speed

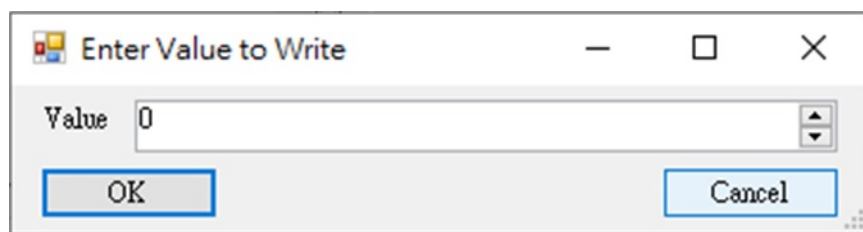

- C. Select this **AI_IntegrationTime** and right click **Monitor**

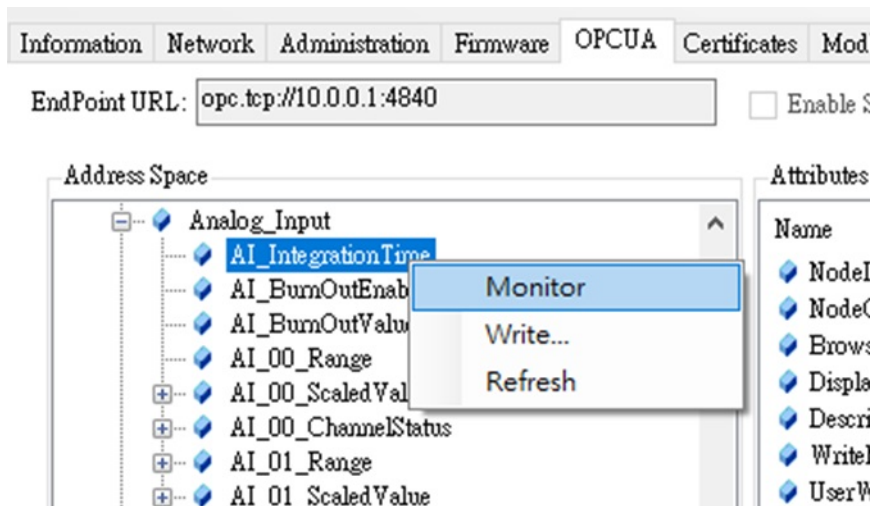

And you can see this node(**AI_IntegrationTime**) in **Data Access View** box. Or you can left click and drag this node(**AI_IntegrationTime**) in **Data Access View** box.

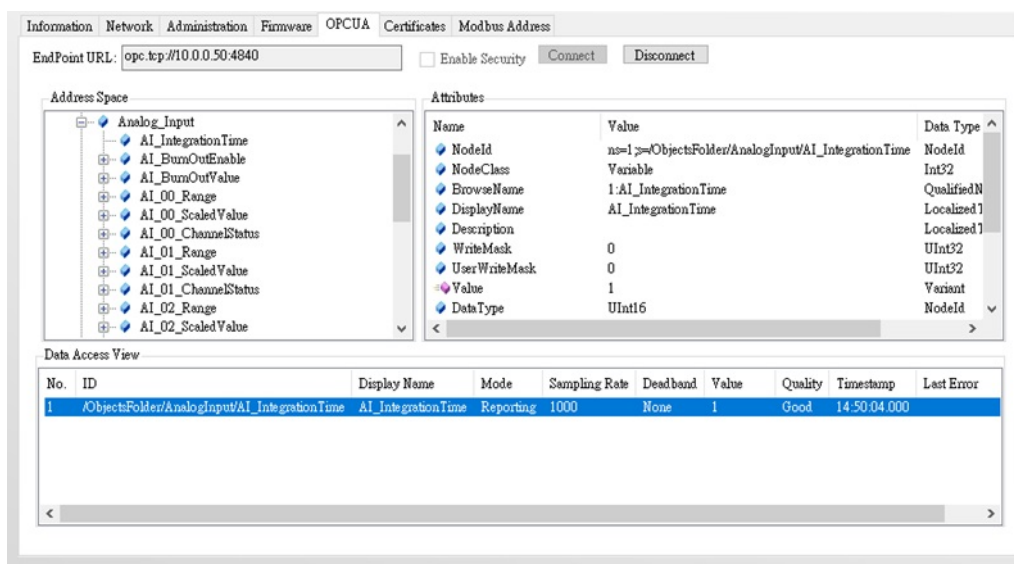

2. Burnout

You can enable burn out function, to select **AI_BurnOutEnable** and right click **Write**. Note, it is only for 4 - 20mA input range.

A. Select **AI_BurnOutEnable** and right click **Write**

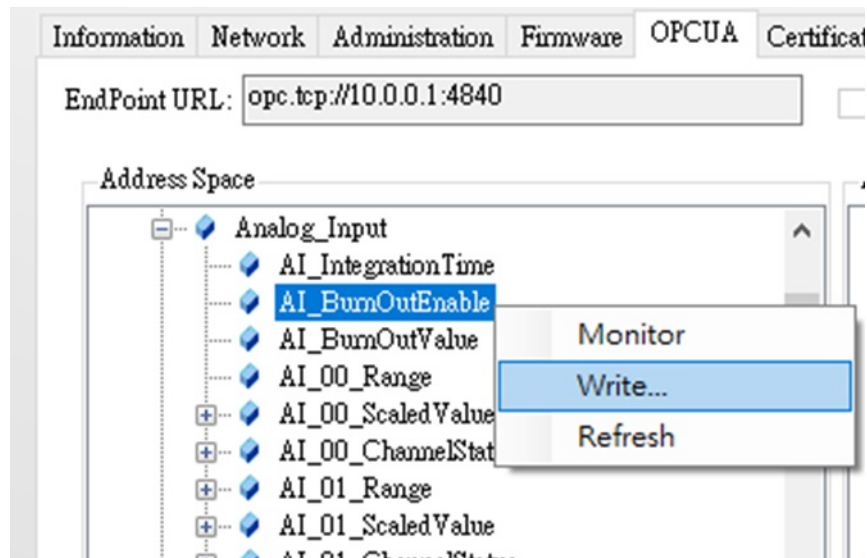

B. Select True or False to enable or disable this function.

- a. True: enable burn out function
- b. False: disable burn out function

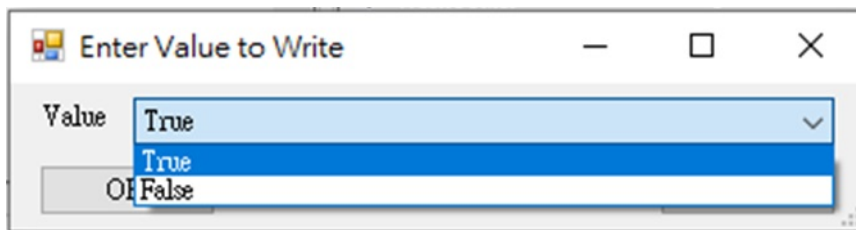

C. Select **AI_BurnOutEnable** and right click **Monitor**.

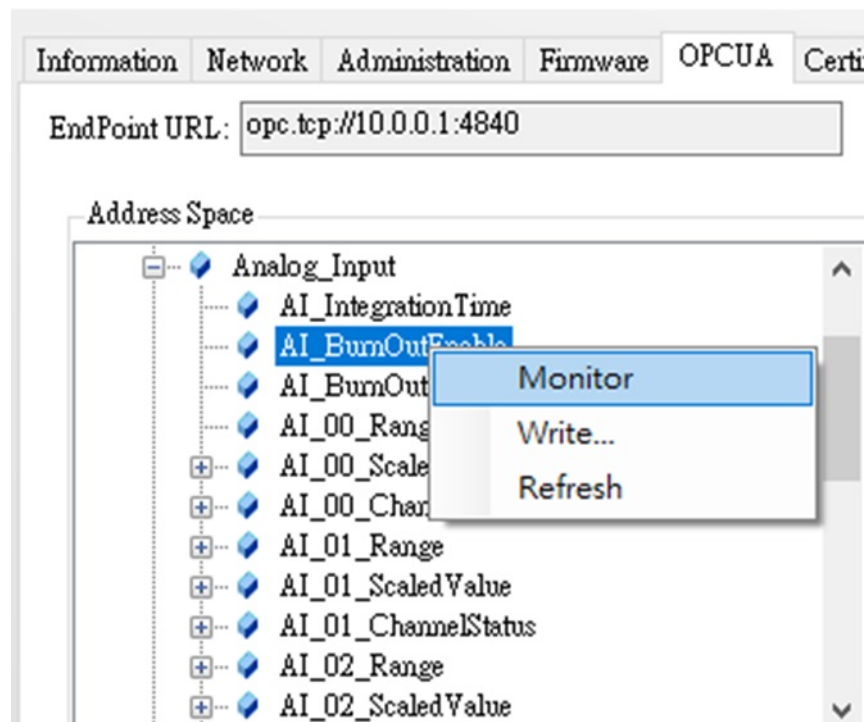

3. Burnout value:

If you select up scale, you will see the value FFFF in Modbus address when open circuit happens. Otherwise, it will show 0000 as down scale. It only supports 4 - 20mA input range.

- A. Select **AI_BurnOutValue** and right click **Write**

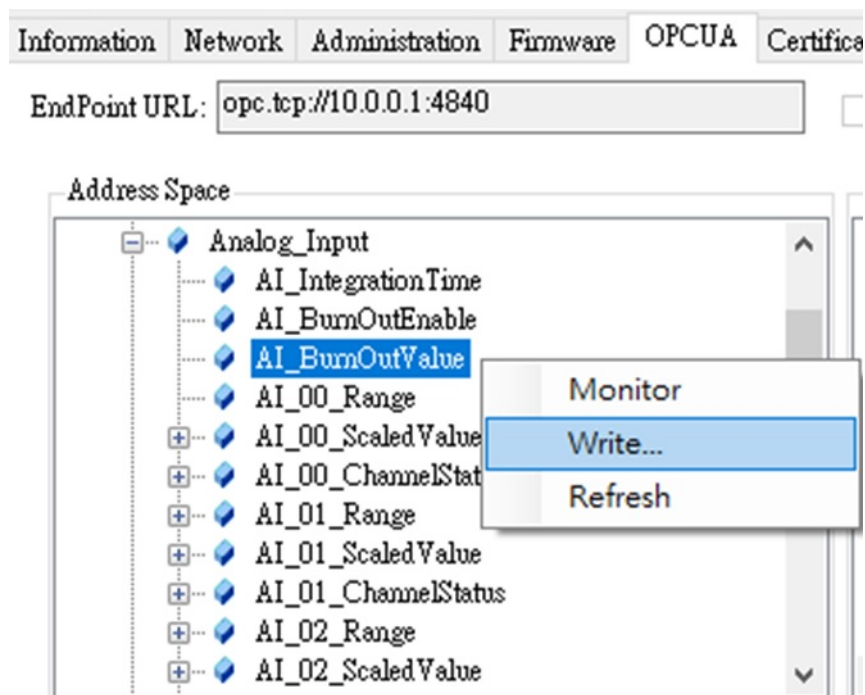

- B. Enter below value to choose up scale or down scale.
- 0: down scale
 - 1: up scale

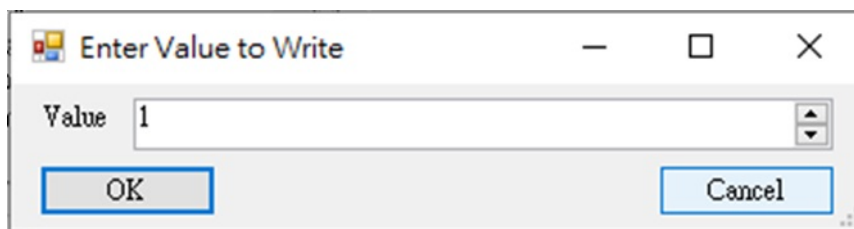

C. Select **AI_BurnOutValue** and right click **Monitor**

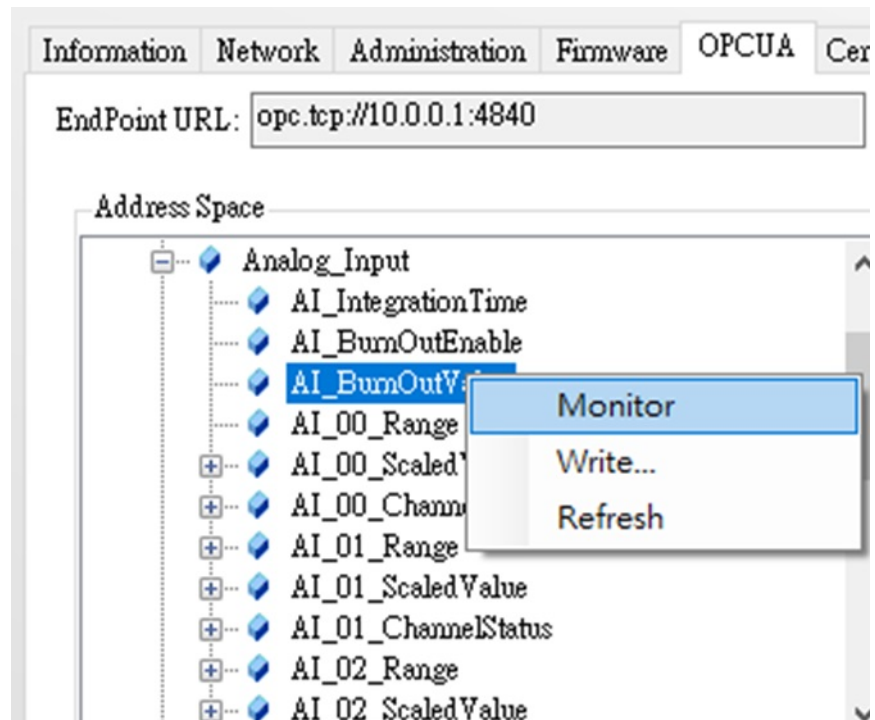

Note! You need to enter **1** in **AI_BurnOutEnable** to enable burn out function at first. Then you can select up scale or down scale.



4.6.1.2 Individual Channel Configuration

1. Input range

This node allows you to set a different range for each channel.

A. Select **AI_(Channel)_Range** and right click **Write**

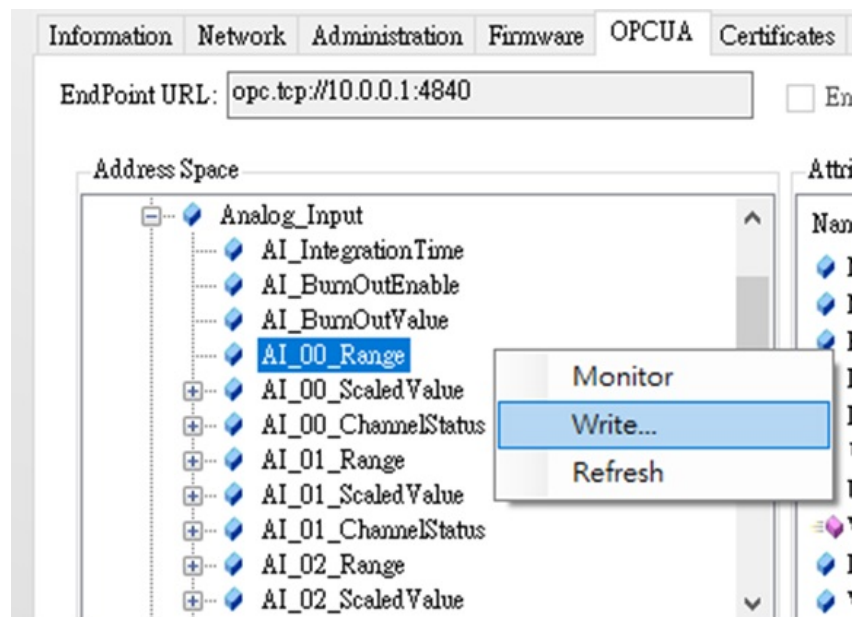

- B. Enter below value to choose different input ranges.

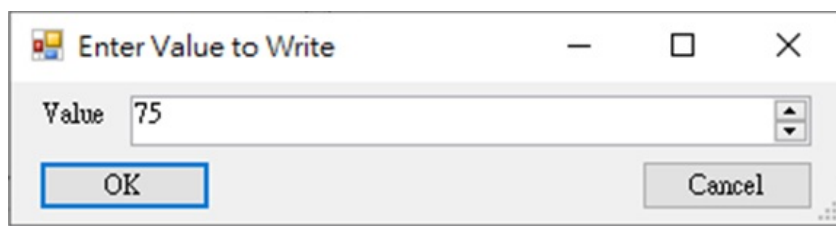

Enter Value	Input Range
7	4~20 mA
8	± 10 V
9	± 5 V
10	± 1 V
11	± 500 mV
12	± 150 mV
13	± 20 mA
72	0 ~ 10 V
73	0 ~ 5 V
74	0 ~ 1 V
75	0 ~ 500 mV
76	0 ~ 150 mV
77	0 ~ 20 mA

- C. Select this **AI_(Channel)_Range** and right click **Monitor**.
You can see this node **AI_(Channel)_Range** in **Data Access View** box

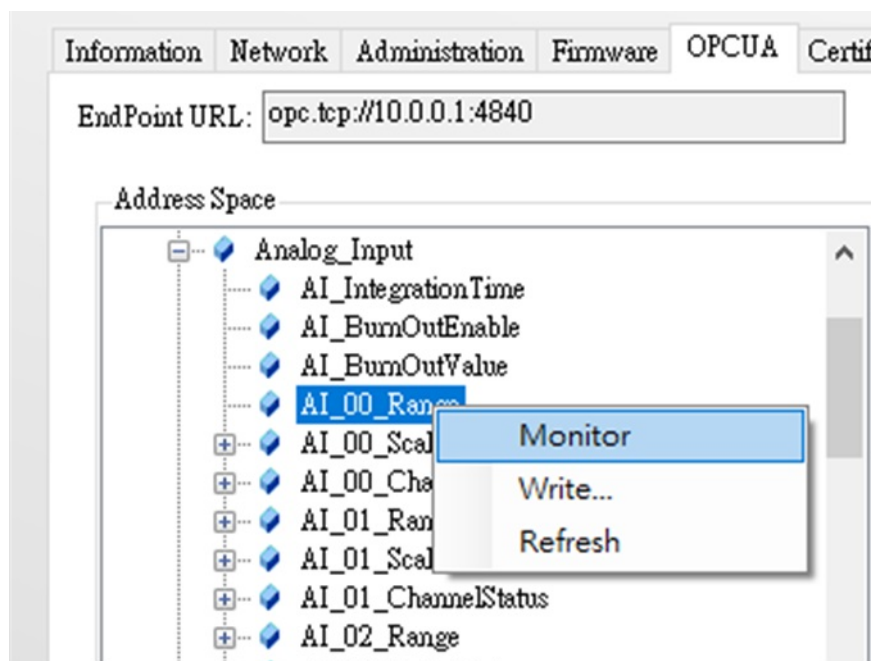

2. **AI_(Channel)_ScaledValue:**

You can see the scaled value if you select this **AI_(Channel)_ScaledValue** and right click **Monitor**.

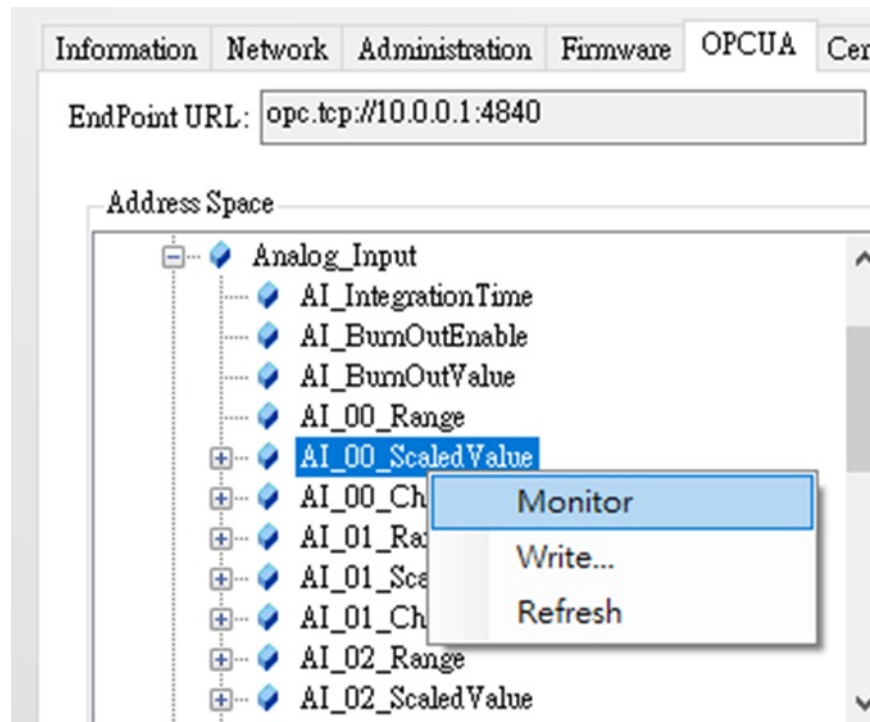

3. **AI_(Channel)_ChannelStatus:**

You can see the channel status if you select this **AI_(Channel)_ChannelStatus** and right click **Monitor**.

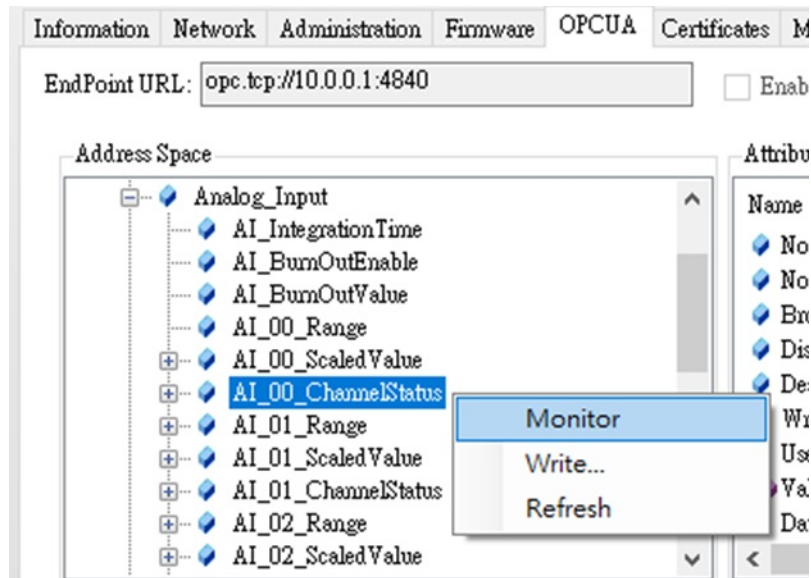

You can see the **Value** of this **AI_(Channel)_ChannelStatus** in **Data Access View**.

- a. 0: good
- b. 4: under range(4-20mA only)
- c. 8: burn out(4-20mA only)

Information Network Administration Firmware OPCUA Certificates Modbus Address

EndPoint URL: Enable Security

Address Space

- [-] Analog_Input
 - [-] AI_IntegrationTime
 - [-] AI_BurnOutEnable
 - [-] AI_BurnOutValue
 - [-] AI_00_Range
 - [-] AI_00_ScaledValue
 - [-] AI_00_ChannelStatus
 - [-] AI_01_Range
 - [-] AI_01_ScaledValue
 - [-] AI_01_ChannelStatus
 - [-] AI_02_Range
 - [-] AI_02_ScaledValue

Attributes

Name	Value	Data Type
NodeId	ns=1, #=ObjectsFolder/AnalogInput/AI_00_ChannelStatus	NodeId
NodeClass	Variable	Int32
BrowseName	1:AI_00_ChannelStatus	Qualified
DisplayName	AI_00_ChannelStatus	Localized
Description		Localized
WriteMask	0	UInt32
UserWriteMask	0	UInt32
Value	0	Variant
DataType	UInt16	NodeId

Data Access View

No.	ID	Display Name	Mode	Sampling Rate	Deadband	Value	Quality	Timestamp	Last Error
1	/ObjectsFolder/AnalogInput/AI_00_ChannelStatus	AI_00_ChannelStatus	Reporting	1000	None	0	Good	17:05:22.000	

4.6.2 Digital input

Please see the below table for I/O channel of ADAM-6300 series.

Model	Analog Input	Digital Input		Digital Output		SSR / Relay
		Support DI mode	Support DI, counter and frequency mode	Support DO mode	Support DO, pulse output, pulse output continue mode	
ADAM-6317	AI0~AI7	DI0~DI4	DI5~DI10	DO0~DO3	DO4~DO9	N/A
ADAM-6350	N/A	DI0~DI11	DI12~DI17	DO0~DO11	DO12~DO17	N/A
ADAM-6360D	N/A	DI0~DI7	DI8~DI13	N/A	DO0~DO5	SSR 0~7
ADAM-6366	N/A	DI0~DI11	DI12~DI17	N/A	DO0~DO5	Relay 0~5

4.6.2.1 DI mode introduction

There are two types of DI channels in ADAM-6300. The first type of DI channel only supports DI mode, the second type of DI channel supports DI, counter, and frequency mode. The latter channel supports 3 kHz counter input and 3 kHz frequency input.

4.6.2.2 DI configuration in OPC UA tab

- DI mode: (Please refer below contents when you want to use DI mode)
 - Select **DI_(channel)_DIValue** and right click **Monitor** to monitor this DI status.

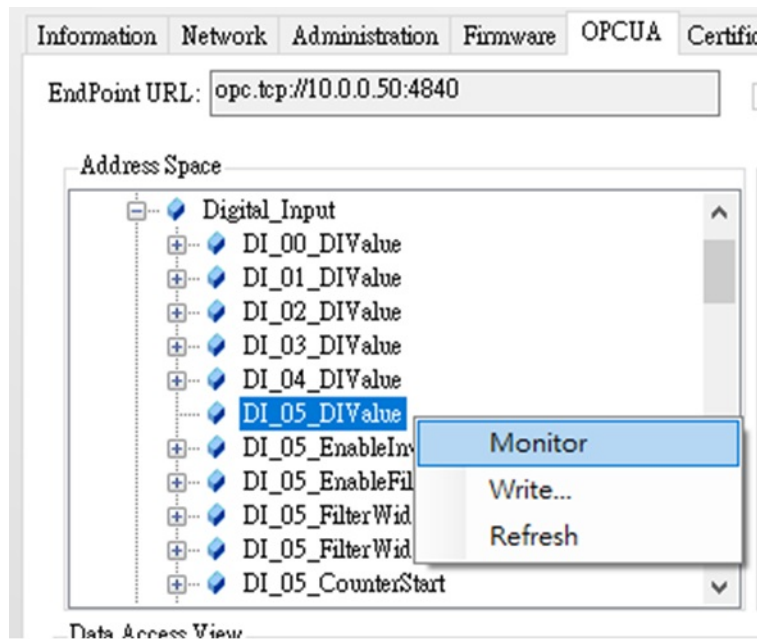

B. Invert signal

- a. Select **DI_(channel)_EnableInvert** and right click **Write**

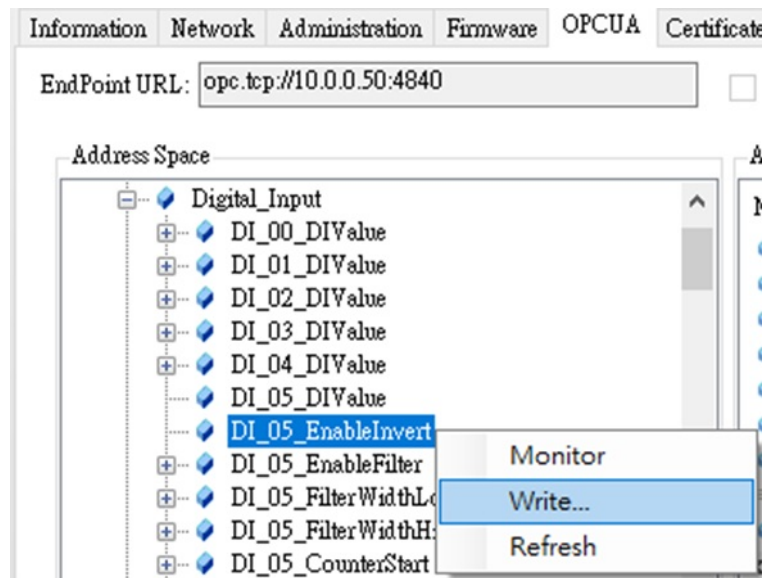

- b. Select **True** or **False** to enable or disable this function. The default setting is false.

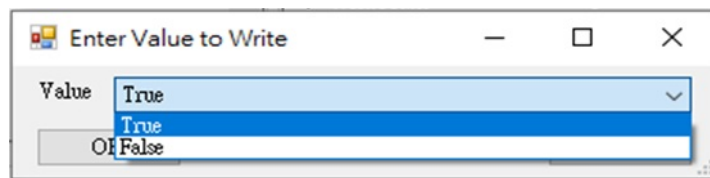

- c. Right click to select **Monitor** to monitor this function.

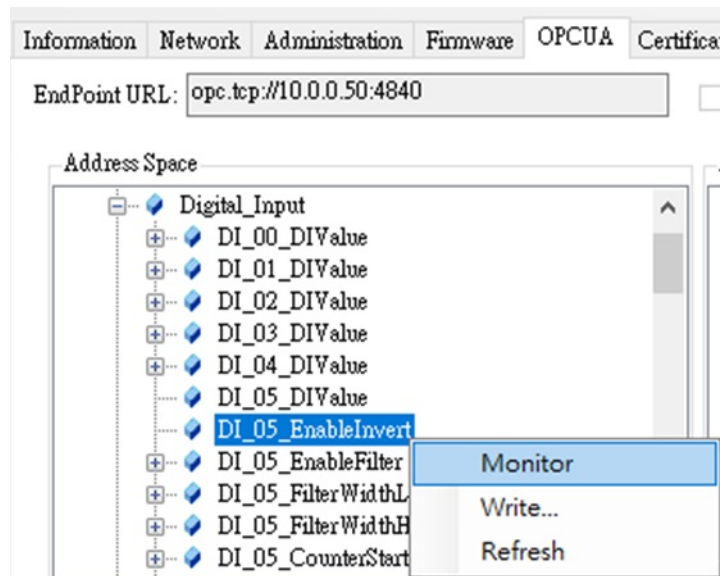

C. Digital filter

Contains minimum high signal width and minimum low signal width (1-65535) for filtering the noise.

- a. Select **DI_(channel)_EnableFilter** and right click **Write**

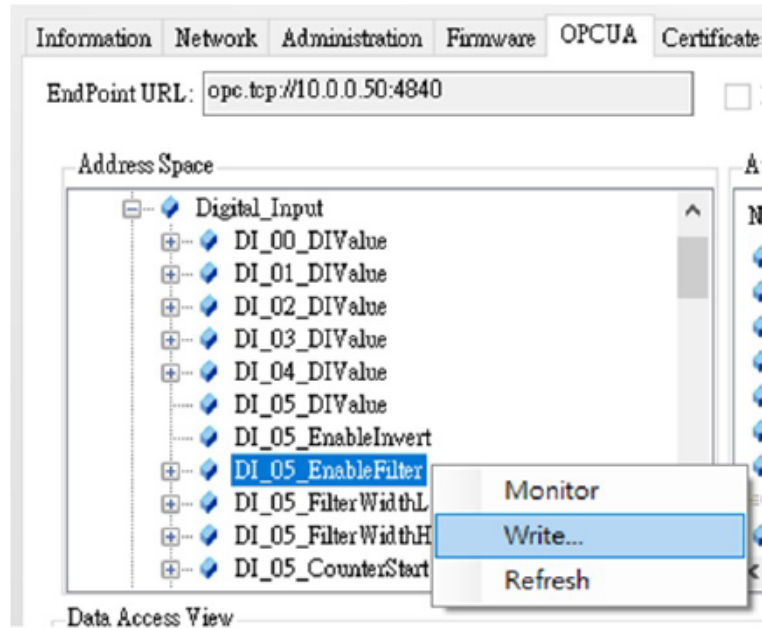

- b. Select True or False to enable or disable this function. The default setting is false.

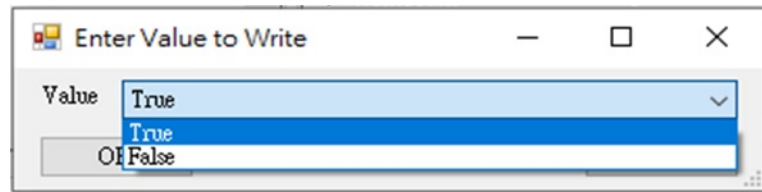

- c. Select **DI_(channel)_EnableInvert**, **DI_(channel)_FilterWidthLow** and **DI_(channel)_FilterWidth-High**

You can define the filter width in the low signal width (right click **Write** in selected **DI_(channel)_FilterWidthLow**), and high signal width (right

click **Write** in selected **DI_(channel)_FilterWidthHigh**), to enter **1~65535** (The unit is 0.1ms).

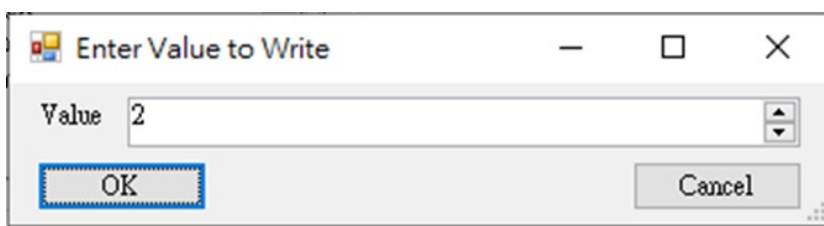
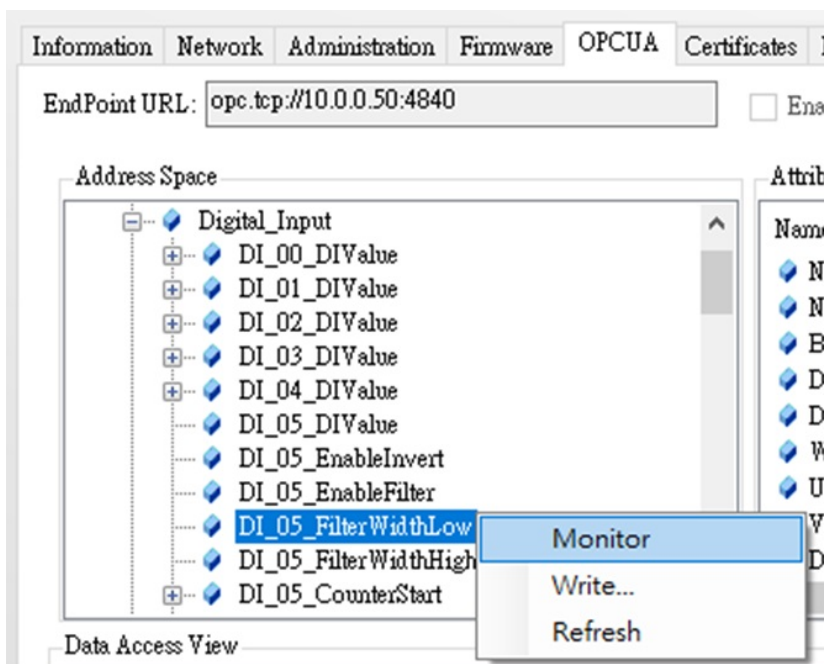

- d. After above setting, left click and drag each of nodes of **DI_(channel)_EnableFilter**, **DI_(channel)_FilterWidthLow** and **DI_(channel)_FilterWidthHigh** to **Data Access View**, and start to monitor these nodes.

2. Counter mode:

A counter counts the number of pulse numbers of a digital signal from the selected channel and then records.

- A. Select **DI_(channel)_CounterStart**, and right click **Write**, click **True** to start counter and click **False** to close counter. The default setting is True.

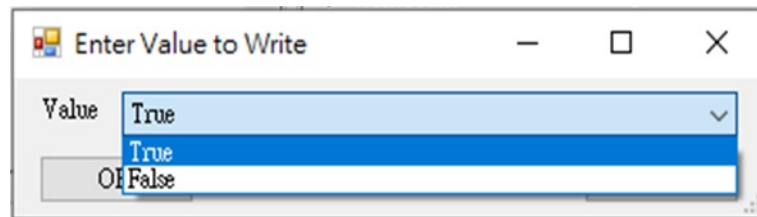
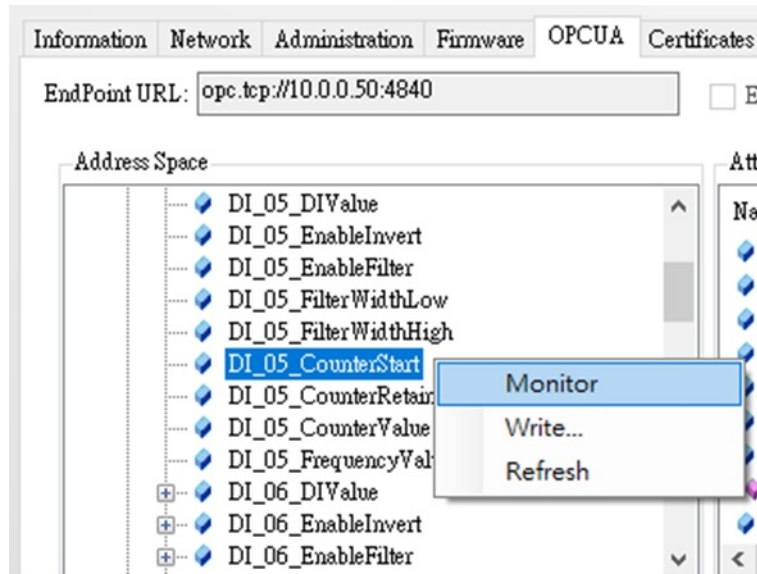

B. Select **DI_(channel)_CounterValue**

- a. When **DI_(channel)_CounterValue** is added **Data Access View**, the current count value of the selected channel will be displayed in the **Value** of **Attributes** of this **DI_(channel)_CounterValue**.
- b. You can right click to select Write and enter 0 to clean current counter value.

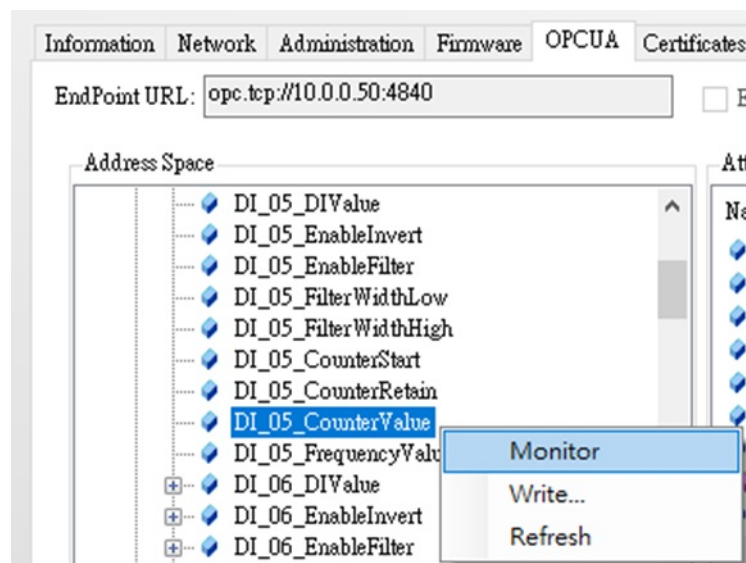

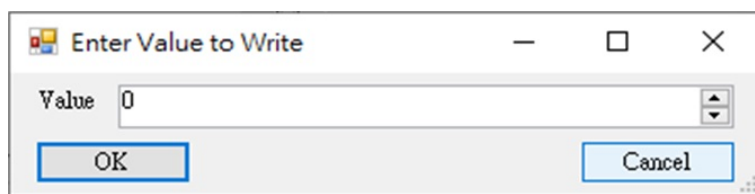

- C. Select **DI_(channel)_CounterRemain**
 The function of counter remain is to keep last counter value when power off.
- a. Right click **Write**

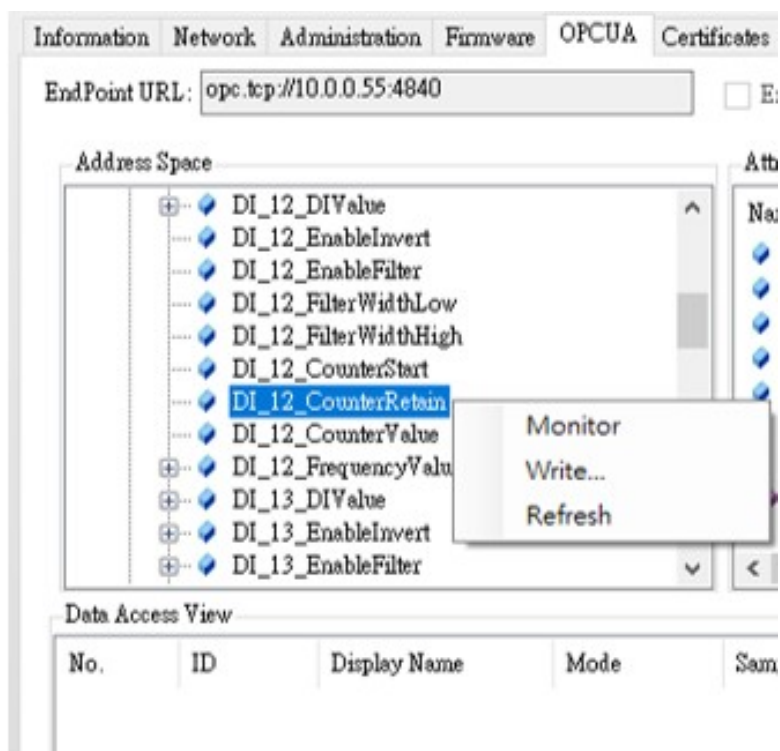

- b. Select **True** or **False** to enable or disable the function.

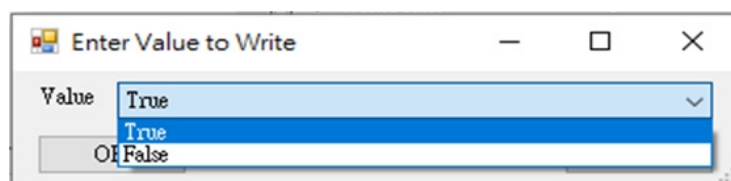

- D. You can add the nodes of **EnableInvert**, **EnableFilter**, **FilterWidthLow**, **FilterWidthHigh** functions in **Counter mode** if user need these functions.

3. Frequency mode:
When Frequency is selected, the module will calculate the frequency of the digital input signal for the selected channel.
- A. Select **DI_(channel)_FrequencyValue** and right click **Monitor**

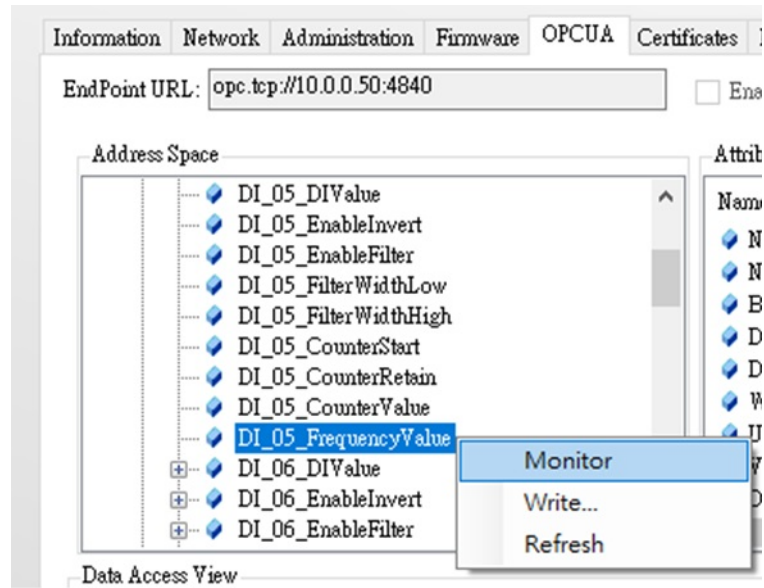

- B. The current frequency value of the selected channel will be displayed in the **Value of Attributes** of this **DI_(channel)_ FrequencyValue** in **Data Access View**.

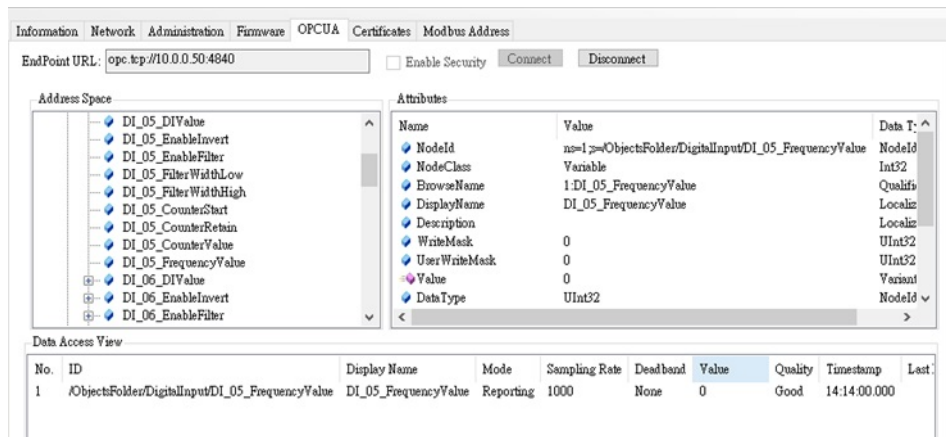

4.6.3 Digital Output

Please see the below table for I/O channel of ADAM-6300 series.

Model	Analog Input	Digital Input		Digital Output		SSR / Relay
		Support DI mode	Support DI, counter and frequency mode	Support DO mode	Support DO, pulse output, pulse output continue mode	
ADAM-6317	AI0~AI7	DI0~DI4	DI5~DI10	DO0~DO3	DO4~DO9	N/A
ADAM-6350	N/A	DI0~DI11	DI12~DI17	DO0~DO11	DO12~DO17	N/A
ADAM-6360D	N/A	DI0~DI7	DI8~DI13	N/A	DO0~DO5	SSR 0~7
ADAM-6366	N/A	DI0~DI11	DI12~DI17	N/A	DO0~DO5	Relay 0~5

4.6.3.1 DO mode introduction

There are two type of DO channels in ADAM-6300. The first type of DO channel is only to support DO mode, the second type of DO channel is to support DO mode, Pulse output mode, Pulse output continue mode. The latter channel supports 3 kHz pulse output.

4.6.3.2 DO configuration in OPC UA tab

- DO mode selection:

There are three DO modes including DO mode, Pulse output mode, Pulse output continue mode. To generate a continuous pulse train or infinite number of pulses is Pulse Output Continue, and Pulse Output is for a finite number of pulses.

- Select **DO_(channel)_Mode** and right click **Write**

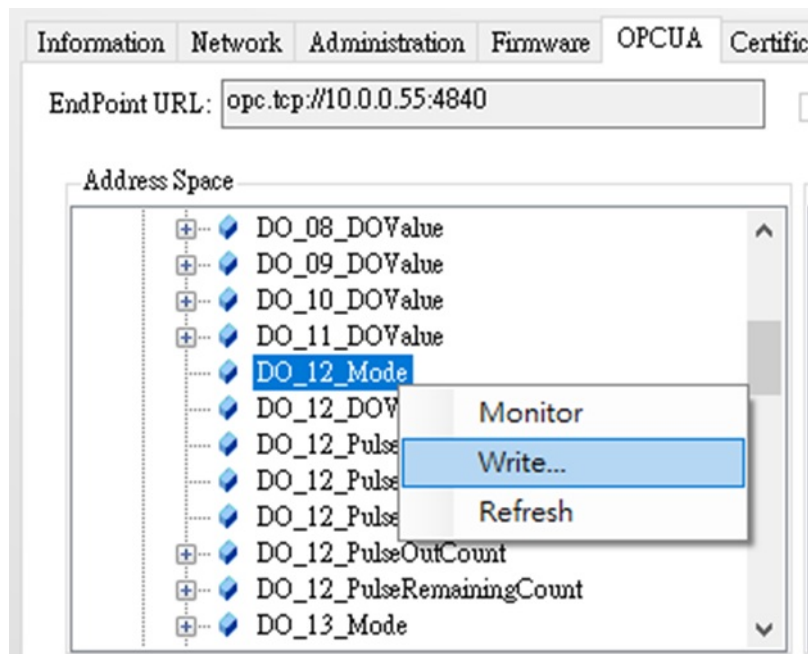

- Enter below value to choose DO mode
 - 0: DO mode
 - 1: Pulse output mode

c. 2: Pulse output continue mode

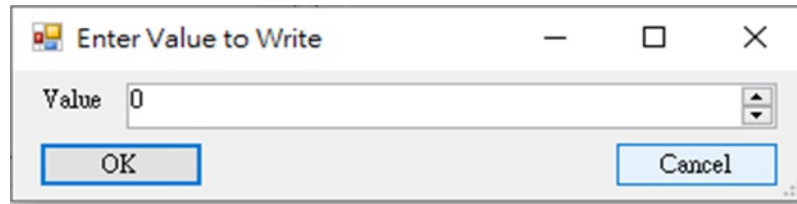

C. Select this **DO_(channel)_Mode** and right click **Monitor**

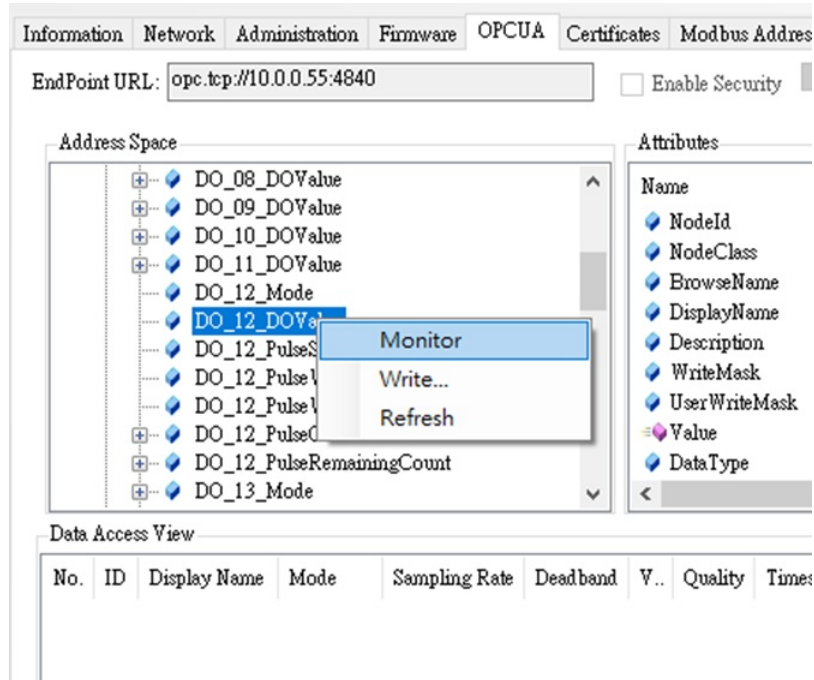

And you can see this node (**DO_12_Mode**) in **Data Access View**. Or you can left click and drag this this node (**DO_12_Mode**) in **Data Access View** box.

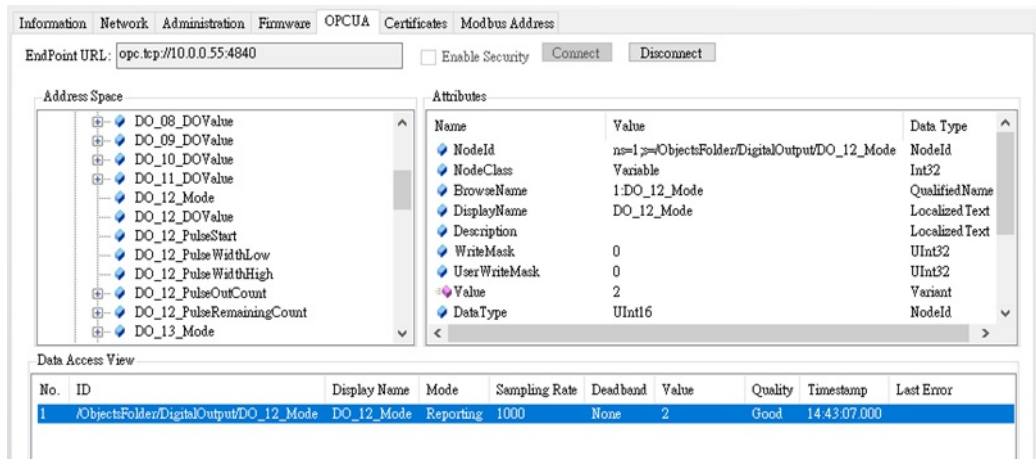

2. DO mode: (Please refer below contents when you want to use DO mode)

A. Select **DO_(channel)_DOValue** and right click to select **Write**

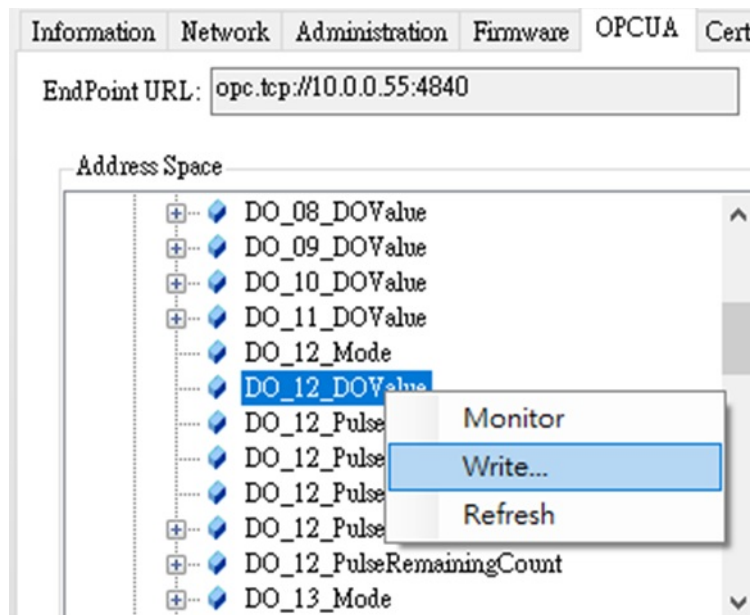

B. And select **True** to turn on the DO. The default setting is false, which means DO off.

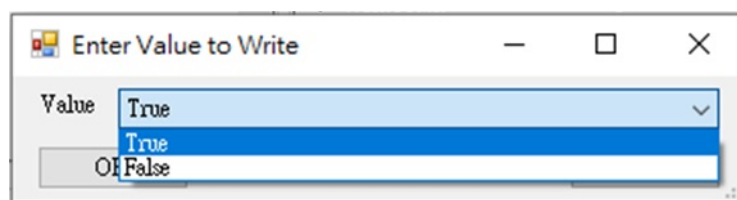

C. Right click to select **Monitor** to monitor this DO status.

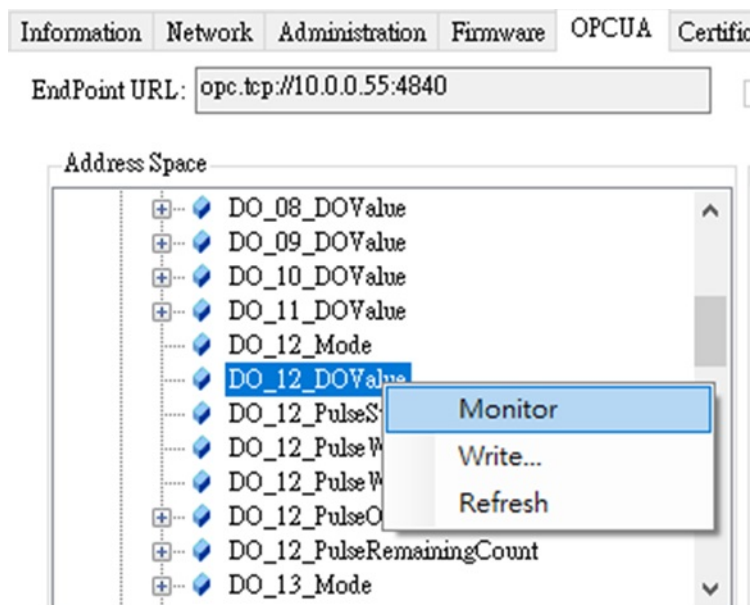

3. Pulse output mode:
Pulse output is for a finite number of pulses. Follow these steps to implement the pulse out function.

- A. Select **DO_(channel)_Mode**, and right click to select **Write** and enter **1**.

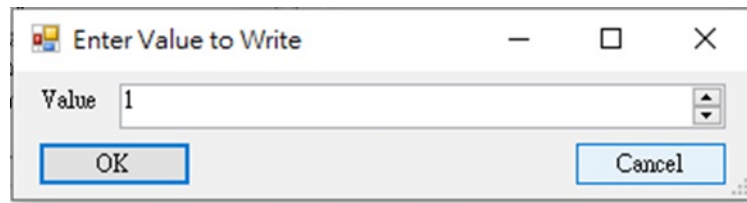
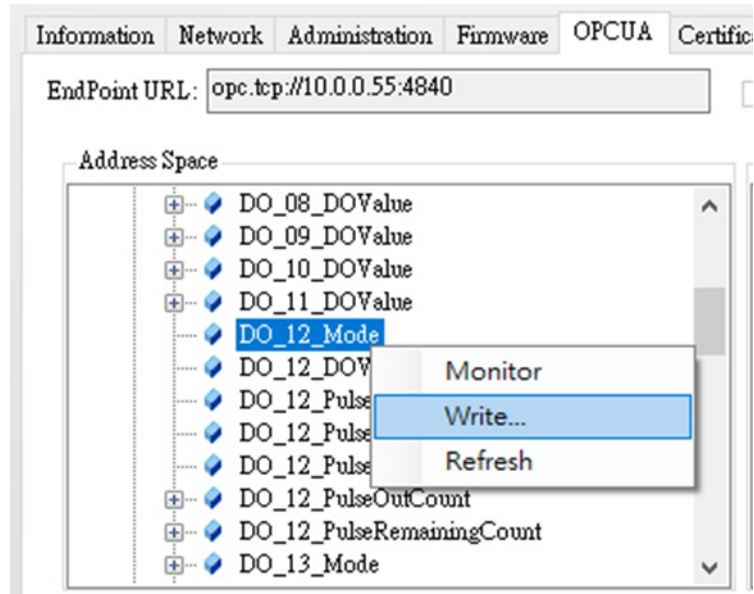

- B. Select **DO_(Channel)_PulseWidthLow** and **DO_(Channel)_PulseWidthHigh**

You can define the pulse width in the low signal width(right click **Write** in selected **DO_(Channel)_PulseWidthLow**), and high signal width(right click **Write** in selected **DO_(Channel)_PulseWidthHigh**), to enter **1~65535**(The unit is 0.1ms). The frequency and duty cycle of the pulse output signal will be calculated automatically.

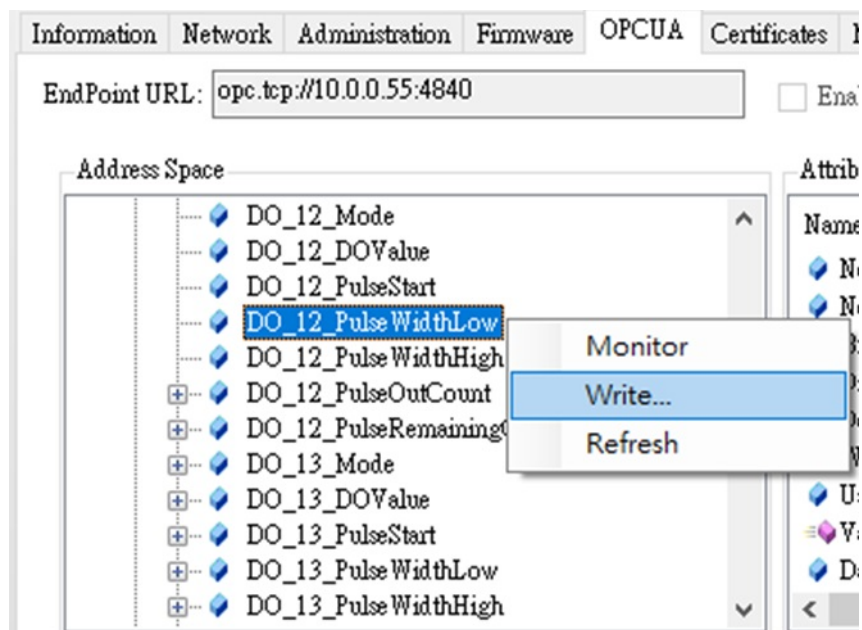

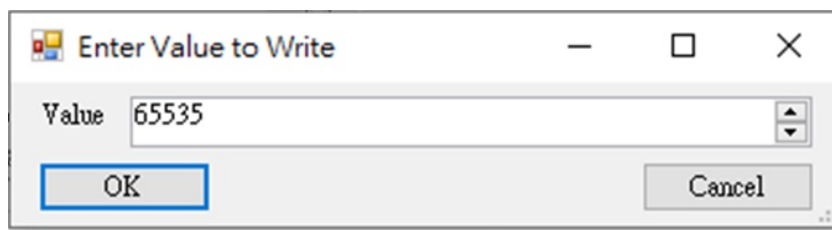

- C. Select **DO_(Channel)_PulseOutputCount**, and right click **Write** the counter number. (The range is 1~4294967295)

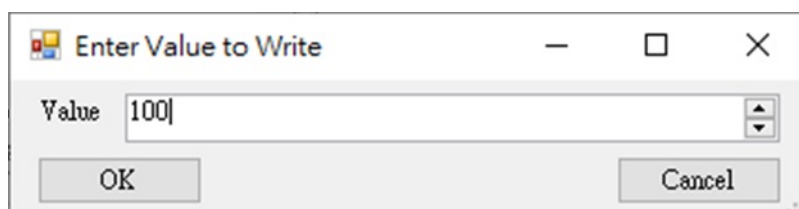
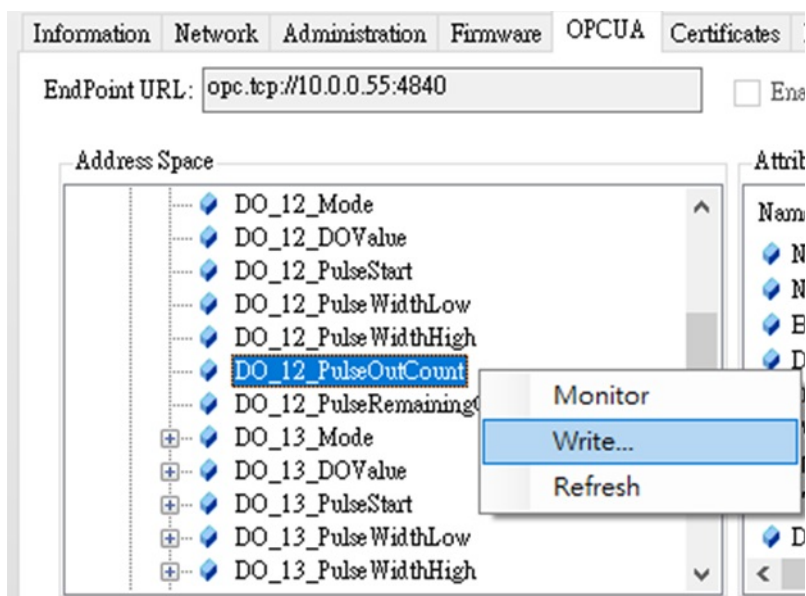

- D. Select **DO_(Channel)_PulseStart**, and right click Write the True to start DO pulse.

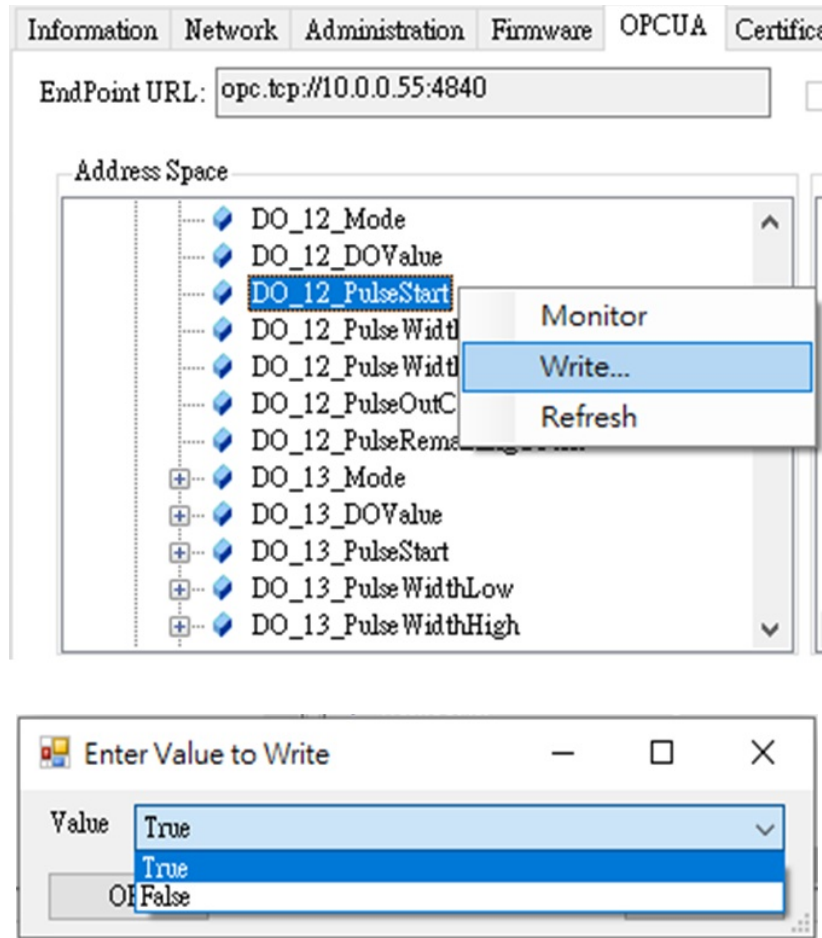

- E. After above setting, left click and drag each of nodes of **DO_(channel)_Mode**, **DO_(Channel)_PulseWidthLow**, **DO_(Channel)_PulseWidthHigh**, **DO_(Channel)_PulseOutputCount**, **DO_(Channel)_PulseStart**, **DO_(Channel)_PulseRemainingCount** to **Data Access View**, and start to monitor these nodes. You can see the remaining counter in **DO_(Channel)_PulseRemainingCount**.

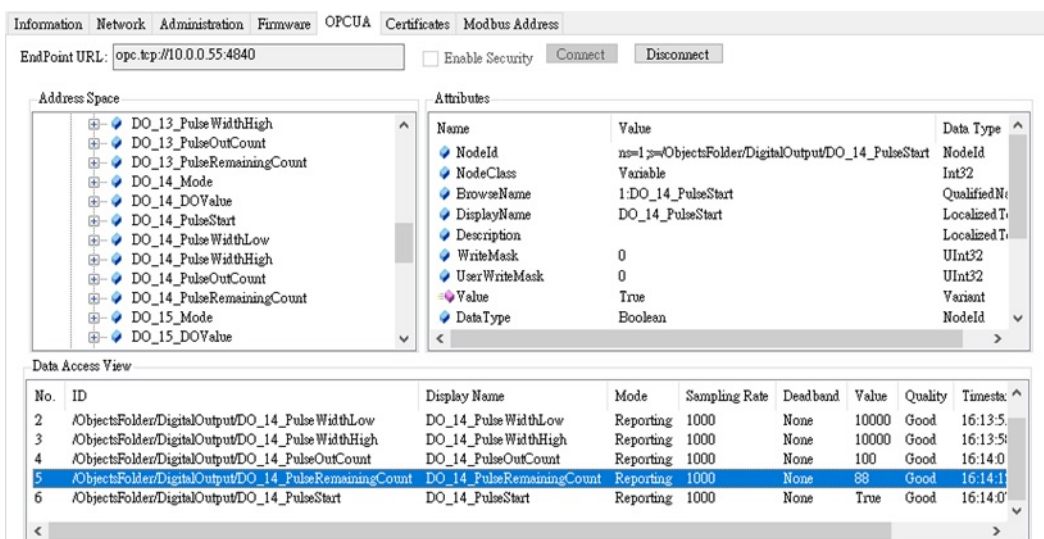

4. Pulse output continue mode
Pulse output Continue (for a pulse train) is to generate a continuous pulse train or finite number of pulses. Please follow below steps to implement pulse out function.
- A. Select **DO_(channel)_Mode**, and right click to select **Write** and enter **2**.

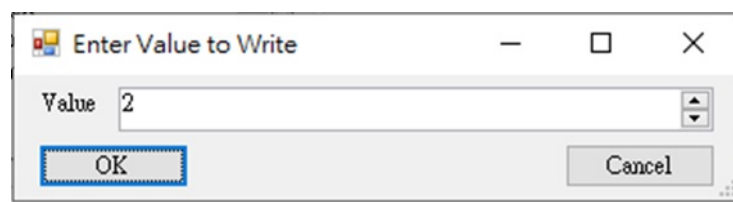
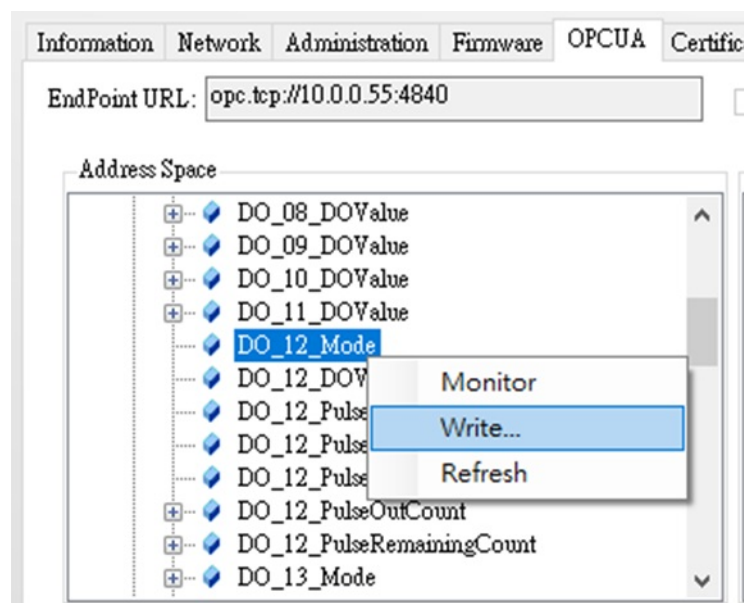

- B. Select **DO_(Channel)_PulseWidthLow** and **DO_(Channel)_PulseWidthHigh**
You can define the pulse width in the low signal width(right click **Write** in selected **DO_(Channel)_PulseWidthLow**),and high signal width(right click **Write** in selected **DO_(Channel)_PulseWidthHigh**), to enter **1~65535**(The unit is 0.1ms). The frequency and duty cycle of the pulse output signal will be calculated automatically.

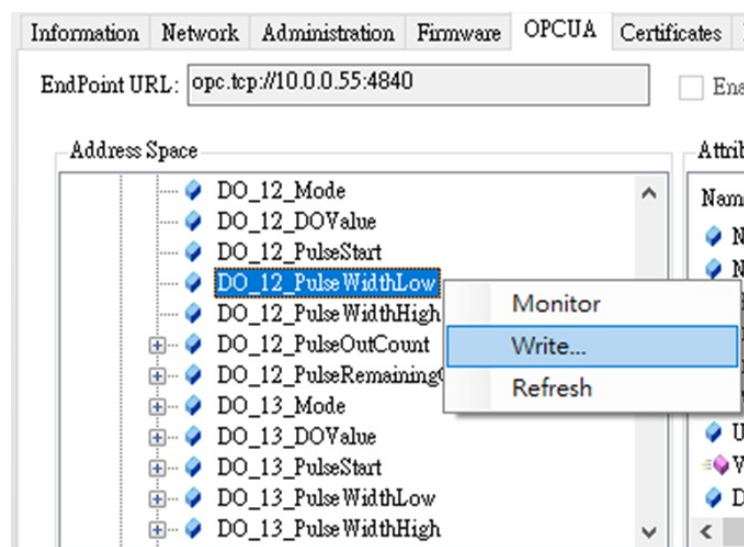

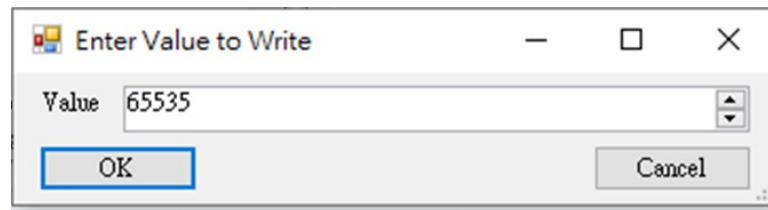

- C. Select **DO_(Channel)_PulseStart**, and right click **Write** the **True** to start DO pulse.

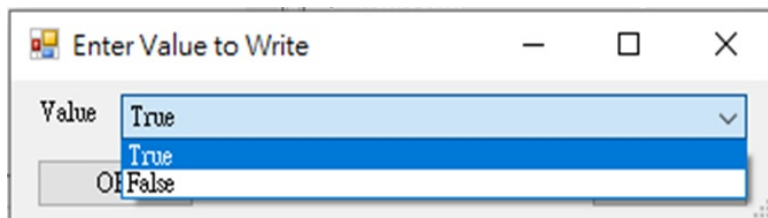
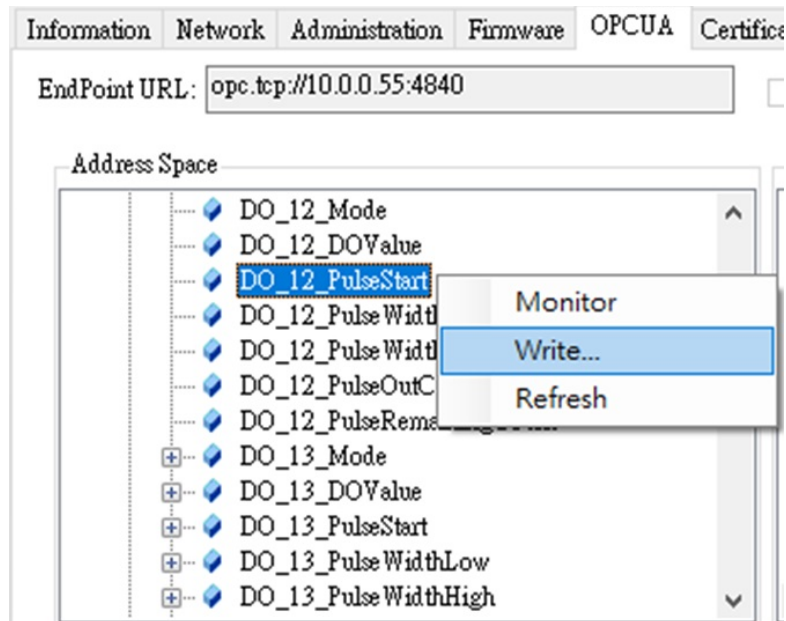

- D. After above settings, left click and drag each of nodes of **DO_(channel)_Mode**, **DO_(Channel)_PulseWidthLow**, **DO_(Channel)_PulseWidthHigh**, **DO_(Channel)_PulseStart** to **Data Access View**, and start to monitor these nodes.

4.6.4 SSR Relay Output

1. SSR Relay Output mode:
 - A. Select **SSR_(channel)_RelayValue** and right click to select **Write**

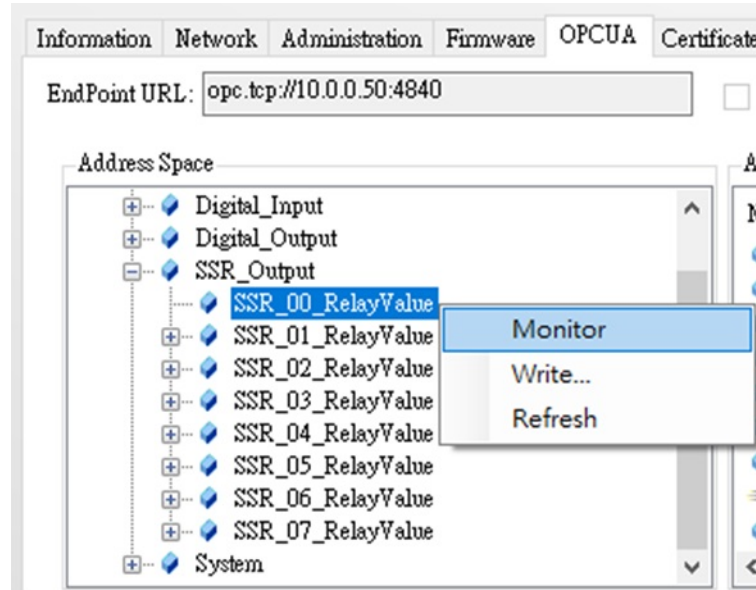

- B. And select **True** to turn on the relay. The default setting is false, which means relay off.

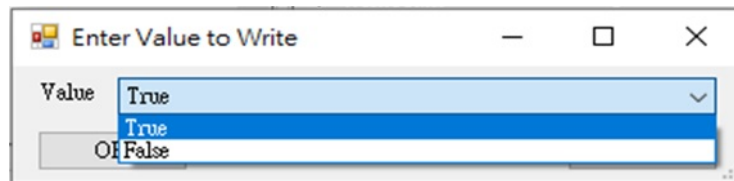

- C. Right click to select **Monitor** to monitor this SSR relay status.

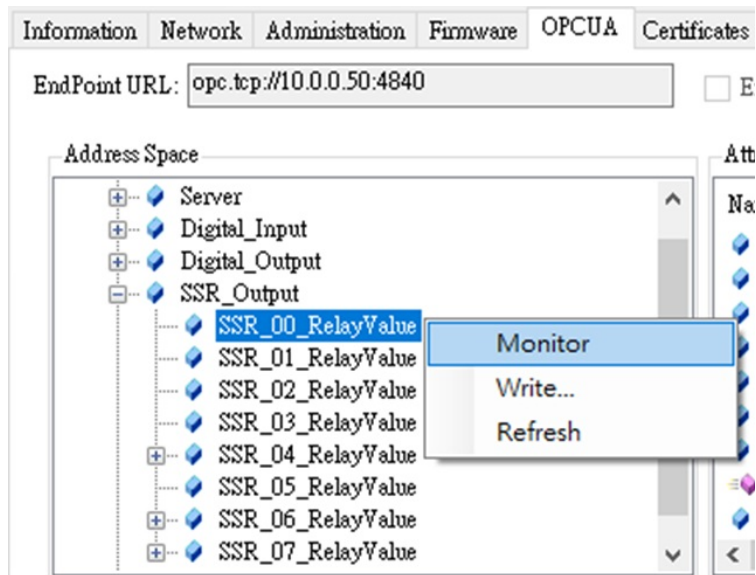

Appendix **A**

Modbus Table

A.1 ADAM-6317: 8AI/11DI/10DO IoT Modbus/OPC UA Ethernet Remote I/O

Address (0X):

Address (0x)	Channel	Description	Attribute
0x0001	0		
0x0002	1		
0x0003	2		
0x0004	3		
0x0005	4		
0x0006	5	DI Value	Read
0x0007	6		
0x0008	7		
0x0009	8		
0x0010	9		
0x0011	10		
0x0033	0		
0x0034	1		
0x0035	2		
0x0036	3		
0x0037	4	DO Value	R/W
0x0038	5		
0x0039	6		
0x0040	7		
0x0041	8		
0x0042	9		
0x0065	5		
0x0066	6		
0x0067	7	DI Stop/Start Counter	R/W
0x0068	8		
0x0069	9		
0x0070	10		
0x0073	5		
0x0074	6		
0x0075	7	DI clear counter	R/W
0x0076	8		
0x0077	9		
0x0078	10		
0x0081	5		
0x0082	6		
0x0083	7	DI enable/disable filter	R/W
0x0084	8		
0x0085	9		
0x0086	10		

0x0089	4		
0x0090	5		
0x0091	6		
0x0092	7	DO start/stop pulse	R/W
0x0093	8		
0x0094	9		

0x0097	0		
0x0098	1		
0x0099	2		
0x0100	3		
0x0101	4	Burnout flag	Read
0x0102	5		
0x0103	6		
0x0104	7		

Address (4X):

Address (4x)	Channel	Description	Attribute
4x0001	0		
4x0002	1		
4x0003	2		
4x0004	3		
4x0005	4	AI Raw Value	Read
4x0006	5		
4x0007	6		
4x0008	7		

4x0009	0		
4x0010	1		
4x0011	2		
4x0012	3		
4x0013	4	AI Channel Status	Read
4x0014	5		
4x0015	6		
4x0016	7		

4x0017			
4x0018	0		
4x0019			
4x0020	1		
4x0021			
4x0022	2		
4x0023			
4x0024	3		
4x0025		AI Scaled Value	Read
4x0026	4		
4x0027			
4x0028	5		
4x0029			
4x0030	6		
4x0031			
4x0032	7		
4x0033			
4x0034	5		
4x0035			
4x0036	6		
4x0037			
4x0038	7		
4x0039		DI Counter Value	Read
4x0040	8		
4x0041			
4x0042	9		
4x0043			
4x0044	10		
4x0045			
4x0046	5		
4x0047			
4x0048	6		
4x0049			
4x0050	7		
4x0051		DI Frequency Value	Read
4x0052	8		
4x0053			
4x0054	9		
4x0055			
4x0056	10		

4x0057					
4x0058	4				
4x0059					
4x0060	5	DO Remained Pulse Output Count	Read		
4x0061	6				
4x0062					
4x0063	7				
4x0064					
4x0065					
4x0066	8	DO Remained Pulse Output Count	Read		
4x0067	9				
4x0068					
4x0101	0				
4x0102	1				
4x0103	2				
4x0104	3	AI Range Type	R/W		
4x0105	4				
4x0106	5				
4x0107	6				
4x0108	7				
4x0109	5				
4x0110	6				
4x0111	7	DI Filter Low Signal Width	R/W		
4x0112	8				
4x0113	9				
4x0114	10				
4x0115	5				
4x0116	6				
4x0117	7	DI Filter High Signal Width	R/W		
4x0118	8				
4x0119	9				
4x0120	10				
4x0121	5				
4x0122	6				
4x0123	7	Pulse Out Low Level Width	R/W		
4x0124	8				
4x0125	9				
4x0126	10				

4x0127	4		
4x0128	5		
4x0129	6	Pulse Out Low Level Width	R/W
4x0130	7		
4x0131	8		
4x0132	9		
4x0133	4		
4x0134			
4x0135	5		
4x0136			
4x0137	6	Total Pulse Output Count	R/W
4x0138	7		
4x0139	8		
4x0140	9		
4x0141			
4x0142	8		
4x0143			
4x0144	9		
4x0221	All	All DI Values	Read
4x0222			
4x0223	All	All DO Values	R/W
4x0224			

A.2 ADAM-6350: 18DI/18DO IoT Modbus/OPC UA Ethernet Remote I/O

Address (0X):

Address (0x)	Channel	Description	Attribute
0x0001	0		
0x0002	1		
0x0003	2		
0x0004	3		
0x0005	4		
0x0006	5		
0x0007	6		
0x0008	7		
0x0009	8	DI Value	Read
0x0010	9		
0x0011	10		
0x0012	11		
0x0013	12		
0x0014	13		
0x0015	14		
0x0016	15		
0x0017	16		
0x0018	17		
<hr/>			
0x0033	0		
0x0034	1		
0x0035	2		
0x0036	3		
0x0037	4		
0x0038	5		
0x0039	6		
0x0040	7		
0x0041	8	DO Value	R/W
0x0042	9		
0x0043	10		
0x0044	11		
0x0045	12		
0x0046	13		
0x0047	14		
0x0048	15		
0x0049	16		
0x0050	17		

0x0065	12		
0x0066	13		
0x0067	14	DI Stop/Start Counter	R/W
0x0068	15		
0x0069	16		
0x0070	17		

0x0073	12		
0x0074	13		
0x0075	14	DI clear counter	R/W
0x0076	15		
0x0077	16		
0x0078	17		

0x0081	12		
0x0082	13		
0x0083	14	DI enable/disable filter	R/W
0x0084	15		
0x0085	16		
0x0086	17		

0x0089	12		
0x0090	13		
0x0091	14	DO start/stop pulse	R/W
0x0092	15		
0x0093	16		
0x0094	17		

Address (4X):

Address (4x)	Channel	Description	Attribute	
4x0033	12			
4x0034				
4x0035				
4x0036				
4x0037	14			
4x0038		DI Counter Value	Read	
4x0039				
4x0040				
4x0041				
4x0042	16			
4x0043	17			
4x0044				

4x0045			
4x0046	12		
4x0047			
4x0048	13		
4x0049			
4x0050	14		
4x0051		DI Frequency Value	Read
4x0052	15		
4x0053			
4x0054	16		
4x0055			
4x0056	17		
4x0057			
4x0058	12		
4x0059			
4x0060	13		
4x0061		DO Remained Pulse Output Count	Read
4x0062	14		
4x0063			
4x0064	15		
4x0065			
4x0066	16		
4x0067		DO Remained Pulse Output Count	Read
4x0068	17		
4x0109	12		
4x0110	13		
4x0111	14		
4x0112	15	DI Filter Low Signal Width	R/W
4x0113	16		
4x0114	17		
4x0115	12		
4x0116	13		
4x0117	14		
4x0118	15	DI Filter High Signal Width	R/W
4x0119	16		
4x0120	17		
4x0121	12		
4x0122	13		
4x0123	14		
4x0124	15	Pulse Out Low Level Width	R/W
4x0125	16		
4x0126	17		

4x0127	12		
4x0128	13		
4x0129	14	Pulse Out Low Level Width	R/W
4x0130	15		
4x0131	16		
4x0132	17		
4x0133	12		
4x0134			
4x0135	13		
4x0136			
4x0137	14	Total Pulse Output Count	R/W
4x0138	15		
4x0139	16		
4x0140	17		
4x0141			
4x0142			
4x0143			
4x0144			
4x0221	All	All DI Values	Read
4x0222			
4x0223	All	All DO Values	R/W
4x0224			

A.3 ADAM-6360D: 8Relay(SSR)/14DI/6DO IoT Modbus/OPC UA Ethernet Remote I/O

Address (0X):

Address (0x)	Channel	Description	Attribute		
0x0001	0				
0x0002	1				
0x0003	2				
0x0004	3				
0x0005	4				
0x0006	5				
0x0007	6	DI Value	Read		
0x0008	7				
0x0009	8				
0x0010	9				
0x0011	10				
0x0012	11				
0x0013	12				
0x0014	13				
<hr/>					
0x0033	0				
0x0034	1				
0x0035	2				
0x0036	3	SSR Value	R/W		
0x0037	4				
0x0038	5				
0x0039	6				
0x0040	7				
<hr/>					
0x0041	0				
0x0042	1				
0x0043	2	DO Value	R/W		
0x0044	3				
0x0045	4				
0x0046	5				
<hr/>					
0x0065	8				
0x0066	9				
0x0067	10	DI Stop/Start Counter	R/W		
0x0068	11				
0x0069	12				
0x0070	13				
<hr/>					

0x0073	8		
0x0074	9		
0x0075	10		
0x0076	11	DI clear counter	R/W
0x0077	12		
0x0078	13		
0x0081	8		
0x0082	9		
0x0083	10		
0x0084	11	DI enable/disable filter	R/W
0x0085	12		
0x0086	13		

0x0089	0		
0x0090	1		
0x0091	2		
0x0092	3	DO start/stop pulse	R/W
0x0093	4		
0x0094	5		

Address (4X):

Address (4x)	Channel	Description	Attribute
4x0033	8		
4x0034	9		
4x0035	10		
4x0036	11		
4x0037	12		
4x0038	13	DI Counter Value	Read
4x0039	8		
4x0040	9		
4x0041	10		
4x0042	11		
4x0043	12		
4x0044	13		

4x0045	8		
4x0046	9		
4x0047	10		
4x0048	11		
4x0049	12		
4x0050	13	DI Frequency Value	Read
4x0051	8		
4x0052	9		
4x0053	10		
4x0054	11		
4x0055	12		
4x0056	13		

4x0057			
4x0058	0		
4x0059			
4x0060	1	DO Remained Pulse Output	Read
4x0061		Count	
4x0062	2		
4x0063			
4x0064	3		
4x0065			
4x0066	4	DO Remained Pulse Output	Read
4x0067		Count	
4x0068	5		
4x0109	8		
4x0110	9		
4x0111	10	DI Filter Low Signal Width	R/W
4x0112	11		
4x0113	12		
4x0114	13		
4x0115	8		
4x0116	9		
4x0117	10	DI Filter High Signal Width	R/W
4x0118	11		
4x0119	12		
4x0120	13		
4x0121	0		
4x0122	1		
4x0123	2	Pulse Out Low Level Width	R/W
4x0124	3		
4x0125	4		
4x0126	5		
4x0127	0		
4x0128	1		
4x0129	2	Pulse Out High Level Width	R/W
4x0130	3		
4x0131	4		
4x0132	5		

4x0133			
4x0134	0		
4x0135			
4x0136	1		
4x0137			
4x0138	2		
4x0139		Total Pulse Output Count	R/W
4x0140	3		
4x0141			
4x0142	4		
4x0143			
4x0144	5		
4x0221			
4x0222	All	All DI Values	Read
4x0223			
4x0224	All	All DO & SSR Values	R/W

A.4 ADAM-6366: 6 Relay /18 DI/ 6 DO IoT Modbus/ OPC UA Ethernet Remote I/O

Address (0x)	channel	Description	Attribute
0x0001	0		
0x0002	1		
0x0003	2		
0x0004	3		
0x0005	4		
0x0006	5		
0x0007	6		
0x0008	7		
0x0009	8	DI Value	Read
0x0010	9		
0x0011	10		
0x0012	11		
0x0013	12		
0x0014	13		
0x0015	14		
0x0016	15		
0x0017	16		
0x0018	17		
<hr/>			
0x0033	0		
0x0034	1		
0x0035	2	Relay Value	R/W
0x0036	3		
0x0037	4		
0x0038	5		
<hr/>			
0x0039	0		
0x0040	1		
0x0041	2	DO Value	R/W
0x0042	3		
0x0043	4		
0x0044	5		
<hr/>			
0x0065	12		
0x0066	13		
0x0067	14	DI Stop/Start Counter	R/W
0x0068	15		
0x0069	16		
0x0070	17		
<hr/>			

0x0073	12		
0x0074	13		
0x0075	14	DI clear counter	R/W
0x0076	15		
0x0077	16		
0x0078	17		

0x0081	12		
0x0082	13		
0x0083	14	DI enable/disable filter	R/W
0x0084	15		
0x0085	16		
0x0086	17		

0x0089	0		
0x0090	1		
0x0091	2	DO start/stop pulse	R/W
0x0092	3		
0x0093	4		
0x0094	5		

Address (4X):

Address (4x)	channel	Description	Attribute	
4x0033	12			
4x0034				
4x0035		13		
4x0036				
4x0037	14			
4x0038		DI Counter Value	Read	
4x0039				
4x0040				
4x0041				
4x0042	16			
4x0043				
4x0044		17		

4x0045	12			
4x0046				
4x0047		13		
4x0048				
4x0049	14			
4x0050		DI Frequency Value	Read	
4x0051				
4x0052				
4x0053				
4x0054	16			
4x0055				
4x0056		17		

4x0057			
4x0058	0		
4x0059			
4x0060	1		
4x0061			Read
4x0062	2	DO Remained Pulse Output	
4x0063		Count	
4x0064	3		
4x0065			
4x0066	4		
4x0067			Read
4x0068	5		
<hr/>			
4x0109	12		
4x0110	13		
4x0111	14	DI Filter Low Signal Width	R/W
4x0112	15		
4x0113	16		
4x0114	17		
<hr/>			
4x0115	12		
4x0116	13		
4x0117	14	DI Filter High Signal Width	R/W
4x0118	15		
4x0119	16		
4x0120	17		
<hr/>			
4x0121	0		
4x0122	1		
4x0123	2	Pulse Out Low Level Width	R/W
4x0124	3		
4x0125	4		
4x0126	5		
<hr/>			
4x0127	0		
4x0128	1		
4x0129	2	Pulse Out High Level Width	R/W
4x0130	3		
4x0131	4		
4x0132	5		

4x0133	0		
4x0134			
4x0135	1		
4x0136			
4x0137	2		
4x0138		Total Pulse Output Count	R/W
4x0139	3		
4x0140			
4x0141	4		
4x0142			
4x0143	5		
4x0144			
4x0221	All	All DI Values	Read
4x0222			
4x0223	All	All DO & SSR Values	R/W
4x0224			

www.advantech.com

Please verify specifications before quoting. This guide is intended for reference purposes only.

All product specifications are subject to change without notice.

No part of this publication may be reproduced in any form or by any means, electronic, photocopying, recording or otherwise, without prior written permission of the publisher.

All brand and product names are trademarks or registered trademarks of their respective companies.

© Advantech Co., Ltd. 2021