



---

# Inverter

Inverter i550 Cabinet 0.25 to 45 kW

*This page intentionally left blank!*

---

**Contents**

**Introduction**.....7

    About Lenze.....7

        The 5 phases .....7

        Portfolio overview.....8

        Inverter overview.....9

    About this document.....12

        Document description.....12

        Conventions.....12

# Contents

---

<b>Inverter</b> .....	<b>13</b>
Product information .....	13
Product description.....	13
Equipment.....	14
The modular inverter system.....	15
The concept.....	15
Topologies / network .....	16
Ways of commissioning.....	17
Functions.....	18
Overview .....	18
Motor control types.....	18
Features .....	19
Motor setting range .....	19
The name of the product.....	21
Project planning.....	22
Procedure of an inverter configuration process.....	22
Dimensioning.....	22
Operation in motor and generator mode.....	26
Overcurrent operation.....	27
General safety instructions.....	28
Application as directed .....	28
Handling .....	29
Residual hazards .....	30
Control cabinet structure.....	31
Arrangement of components.....	31
Shielding.....	31
EMC-compliant wiring.....	32
Earthing concept.....	33
Cable duct route .....	34

---

Technical data.....	35
Standards and operating conditions.....	35
Electrical supply conditions.....	36
1-phase mains connection 230 V.....	37
Rated data.....	37
Fusing and terminal data.....	39
1/3-phase mains connection 230/240 V.....	41
Rated data.....	41
Fusing and terminal data.....	43
3-phase mains connection 400 V.....	45
Rated data.....	45
Fusing and terminal data.....	50
3-phase mains connection 480 V.....	55
Rated data.....	55
Fusing and terminal data.....	60
Dimensions.....	65
0.25 kW ... 0.37 kW.....	65
0.55 kW ... 0.75 kW.....	66
1.1 kW ... 2.2 kW.....	67
3 kW ... 5.5 kW.....	68
7.5 kW ... 11 kW.....	69
15 kW ... 22 kW.....	70
30 kW ... 45 kW.....	71
Product extensions.....	72
Overview.....	72
I/O extensions.....	73
Standard-I/O.....	73
Application I/O.....	74
Data of control connections.....	75
More control connections.....	78
Relay output.....	78
PTC input.....	79
Networks.....	80
CANopen.....	80
Modbus.....	82
PROFIBUS.....	84
EtherCAT.....	86
EtherNet/IP.....	87
PROFINET.....	88
Functional safety.....	89
Safety module.....	89

# Contents

---

Accessories.....	90
Overview.....	90
Operation and diagnostics.....	91
Keypad.....	91
USB module.....	91
WLAN module.....	92
Blanking cover.....	92
Setpoint potentiometer.....	93
Memory modules.....	93
Memory module copier.....	93
Brake resistors.....	94
Mains chokes.....	97
RFI filters / Mains filters.....	99
Sinusoidal filters.....	103
Power supply units.....	104
Brake switches.....	104
Mounting.....	105
Shield mounting kit.....	105
Terminal strips.....	106
Mounting/ installation.....	107
Mains connection.....	112
1-phase mains connection 230 V.....	113
1/3-phase mains connection 230/240 V.....	114
3-phase mains connection 400 V.....	115
3-phase mains connection 480 V.....	116
Motor connection.....	117
Switching in the motor cable.....	117
Connection of motor temperature monitoring.....	117
Brake resistor connection.....	118
Control connections.....	119
Purchase order.....	120
Notes on ordering.....	120
Order code.....	121
<b>Appendix.....</b>	<b>125</b>
Good to know.....	125
Approvals/directives.....	125
Operating modes of the motor.....	126
Motor control types.....	127
Switching frequencies.....	130
Enclosures.....	131



## Introduction

### About Lenze

#### The 5 phases

##### **Lenze makes many things easy for you.**

With our motivated and committed approach, we work together with you to create the best possible solution and set your ideas in motion - whether you are looking to optimise an existing machine or develop a new one. We always strive to make things easy and seek perfection therein. This is anchored in our thinking, in our services and in every detail of our products. It's as easy as that!

##### **1 Developing ideas**

Are you looking to build the best machine possible and already have some initial ideas? Then get these down on paper together with us, starting with small innovative details and stretching all the way to completely new machines. Working together, we will develop an intelligent and sustainable concept that is perfectly aligned with your specific requirements.

##### **2 Drafting concepts**

We see welcome challenges in your machine tasks, supporting you with our comprehensive expertise and providing valuable impetus for your innovations. We take a holistic view of the individual motion and control functions here and draw up consistent, end-to-end drive and automation solutions for you - keeping everything as easy as possible and as extensive as necessary.

##### **3 Implementing solutions**

Our easy formula for satisfied customers is to establish an active partnership with fast decision making processes and an individually tailored offer. We have been using this principle to meet the ever more specialised customer requirements in the field of machine engineering for many years.

##### **4 Manufacturing machines**

Functional diversity in perfect harmony: as one of the few full-range providers in the market, we can provide you with precisely those products that you actually need for any machine task — no more and no less. Our L-force product portfolio a consistent platform for implementing drive and automation tasks, is invaluable in this regard

##### **5 Ensuring productivity**

Productivity, reliability and new performance peaks on a daily basis these are our key success factors for your machine. After delivery, we offer you cleverly devised service concepts to ensure continued safe operation. The primary focus here is on technical support, based on the excellent application expertise of our highly-skilled and knowledgeable after-sales team.

# Introduction





About Lenze  
Portfolio overview









## Portfolio overview

Lenze products undergo the most stringent testing in our own laboratory. This allows us to ensure that you will receive consistently high quality and a long service life. In addition to this, five logistics centres ensure that the Lenze products you select are available for quick delivery anywhere across the globe.

**As easy as that.**

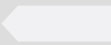
Logic Control	Machine module-Control	Machine Control
Controlling and visualising events	Automating and visualising machine modules	Automating and visualising machines
Visualisation		
Controllers 	 Lenze FAST	

Mains operation	Inverter operation	Servo inverter-operation
Time and event-controlled motion	Speed and torque-controlled motion	Position-controlled single axis and multi-axis motion
Inverters		
Motors 		
Gearboxes 		





## Inverter overview

### Comparison of i500

Inverter	i510			i550		
						
Application area	Pumps and fans, conveyor, travelling, winding, forming, tool and hoist drives					
Electrical supply system	1/N/PE AC 170 ... 264 V 45 ... 65 Hz	3/PE AC 170 ... 264 V 45 ... 65 Hz	3/PE AC 340 ... 528 V 45 ... 65 Hz	1/N/PE AC 170 ... 264 V 45 ... 65 Hz	3/PE AC 170 ... 264 V 45 ... 65 Hz	3/PE AC 340 ... 528 V 45 ... 65 Hz
Motor power	0.25 - 2.2 kW	0.25 - 2.2 kW	0.37 ... 2.2 kW	0.25 - 2.2 kW	0.25 - 2.2 kW	0.37 - 45 kW
Inverter output current	1.7 ... 9.6 A	1.7 ... 9.6 A	1.3 ... 5.6 A	1.7 ... 9.6 A	1.7 ... 9.6 A	1.3 ... 89 A
Inverter efficiency class	IE2 according to EN 50598-2					
Max. inverter output current	150 % at an overload time of 60 s 200 % at an overload time of 3 s					
RFI filters	Integrated	-	Integrated	Integrated	-	integrated up to 22 kW
Dissipation of regenerative energy	-	-	-	Brake resistor	Brake resistor	Brake resistor DC-bus connection
Inverter version	Control cabinet					
Degree of protection	IP20 according to EN 60529					
Inverter mounting type	Installation, easy mounting via keyhole suspension					
Control connections and networks	Basic I/Os  5 digital inputs - 1 digital output 2 analog inputs - 1 analog output  Modbus or CANopen (switchable)			Standard-I/O  5 digital inputs - 1 digital output 2 analog inputs - 1 analog output HTL incremental encoder via 2 digital inputs 10-V output Modbus CANopen EtherCAT EtherNet/IP PROFIBUS PROFINET  Application I/O 7 digital inputs - 2 digital outputs 2 analog inputs - 2 analog outputs HTL incremental encoder via 2 digital inputs		
More connections	Relay			Relay Connection for PTC or thermal contact External 24 V supply		
Functional safety	Without			STO (Safe torque off)		
Approvals	CE, RoHS2, UL (for USA and Canada), EAC					
Interference suppression	Residential areas C1, industrial premises C2					

# Introduction

About Lenze  
Inverter overview



Function	Inverter		Available as of firmware version		
	i510	i550	V1.1	V2.0	V3.0
Motor control					
V/f characteristic control linear/square-law (VFC plus)	•	•	•		
Sensorless vector control (SLVC)	•	•	•		
Energy saving function (VFCeco)	•	•		•	
Servo control for asynchronous motors		•		•	
Motor functions					
SLPSM					•
Torque mode					•
Flying restart circuit	•	•	•		
Slip compensation	•	•	•		
DC braking	•	•	•		
Oscillation damping	•	•	•		
Skip frequencies	•	•	•		
Automatic identification of the motor data	•	•		•	
Brake energy management	•	•	•		
Holding brake control	•	•		•	
Rotational Energy Ride Through (RERT)	•	•		•	
Speed feedback (HTL encoder)		•		•	
DC-bus connection (400V devices)		•	•		
Application functions					
Process controller	•	•		•	
Freely assignable favorite menu	•	•	•		
Parameter change-over	•	•	•		
S-shaped ramps for smooth acceleration	•	•	•		
Motor potentiometer	•	•	•		
Flexible I/O configuration	•	•	•		
Access protection	•	•	•		
Automatic restart	•	•	•		
Monitoring					
Short circuit	•	•	•		
Earth fault	•	•	•		
Device overload monitoring (I x t)	•	•	•		
Motor overload monitoring (I <sup>2</sup> x t)	•	•	•		
Motor phase failure	•	•	•		
Mains phase failure	•	•	•		
Stalling protection	•	•	•		
Motor current limit	•	•	•		
Maximum torque	•	•	•		
Ultimate motor current	•	•	•		
Motor speed monitoring	•	•	•		
Load loss detection	•	•	•		
Motor temperature monitoring		•	•		
Diagnostics					
Error history buffer	•	•	•		
Logbook	•	•	•		
LED status displays	•	•	•		
Keypad language selection German, English	•	•	•		
Network					
CANopen	•	•	•		
Modbus	•	•	•		
PROFIBUS		•	•		
EtherCAT		•		•	
EtherNet/IP		•		•	
PROFINET		•		•	



# Introduction

About Lenze  
Inverter overview

Function	Inverter		Available as of firmware version		
	i510	i550	V1.1	V2.0	V3.0
Safety functions					
STO (Safe torque off)		•	•		

# Introduction

About this document  
Document description



## About this document

### Document description

This document is aimed at all persons who want to project inverters with the described products.

The data and information compiled here serve to support you in dimensioning and selecting and preparing the electrical and mechanical installation. You will receive information on product extensions and accessories.

### Conventions

This document uses the following conventions to distinguish different types of information:

Numbers			
	Decimal separator	Point	In general, the decimal point is used. Example: 1 234.56
Warning			
	UL warning	UL	Are used in English and French.
	UR warning	UR	
Text			
	Programs	» «	Software Example: »Engineer«, »EASY Starter«
Icons			
	Page reference		Reference to another page with additional information Example:  16 = see page 16
	Documentation reference		Reference to another documentation with additional information Example:  EDKxxx = see documentation EDKxxx

### More information

For certain tasks, more information is available in additional documents.

Document	Contents/topics
Commissioning document	Setting and parameterising the inverters
Mounting Instructions	Basic information for the mechanical and electrical installation <ul style="list-style-type: none"><li>• Is supplied with each component.</li></ul>
"Functional safety" configuration document	Information on this (optional) function



Information and tools with regard to the Lenze products can be found on the Internet:  
<http://www.lenze.com> → Download



## Inverter

### Product information

#### Product description

i500 is the new inverter series - a streamlined design, scalable functionality and exceptional user-friendliness.

provides a high-quality frequency inverter that already conforms to future standard in accordance with the EN 50598-2 efficiency classes (IE). Overall, this provides a reliable and future-proof drive for a wide range of machine applications.

#### The i550

This chapter provides the complete scope of the inverter i550. This version is suitable for a very broad use in inverter-operated drives. Basically, the device has the following features:

- All typical motor control types of modern inverters.
- Stroke and continuous operation of the motor according to common operating modes.
- Industry-standard networking opportunities.
- High internal functional range.

#### Highlights

- Compact size
  - Up to 2.2 kW only 60 mm wide
  - Up to 11 kW only 130 mm deep
- Can be directly connected without external cooling
- Innovative interaction options enable better set-up times than ever.
- The wide-ranging modular system enables various product configurations depending on machine requirements.



#### Application ranges

- Pumps and fans
- Conveying and travelling drives
- Forming, tool and hoist drives

# Inverter

Product information  
Equipment



## Equipment

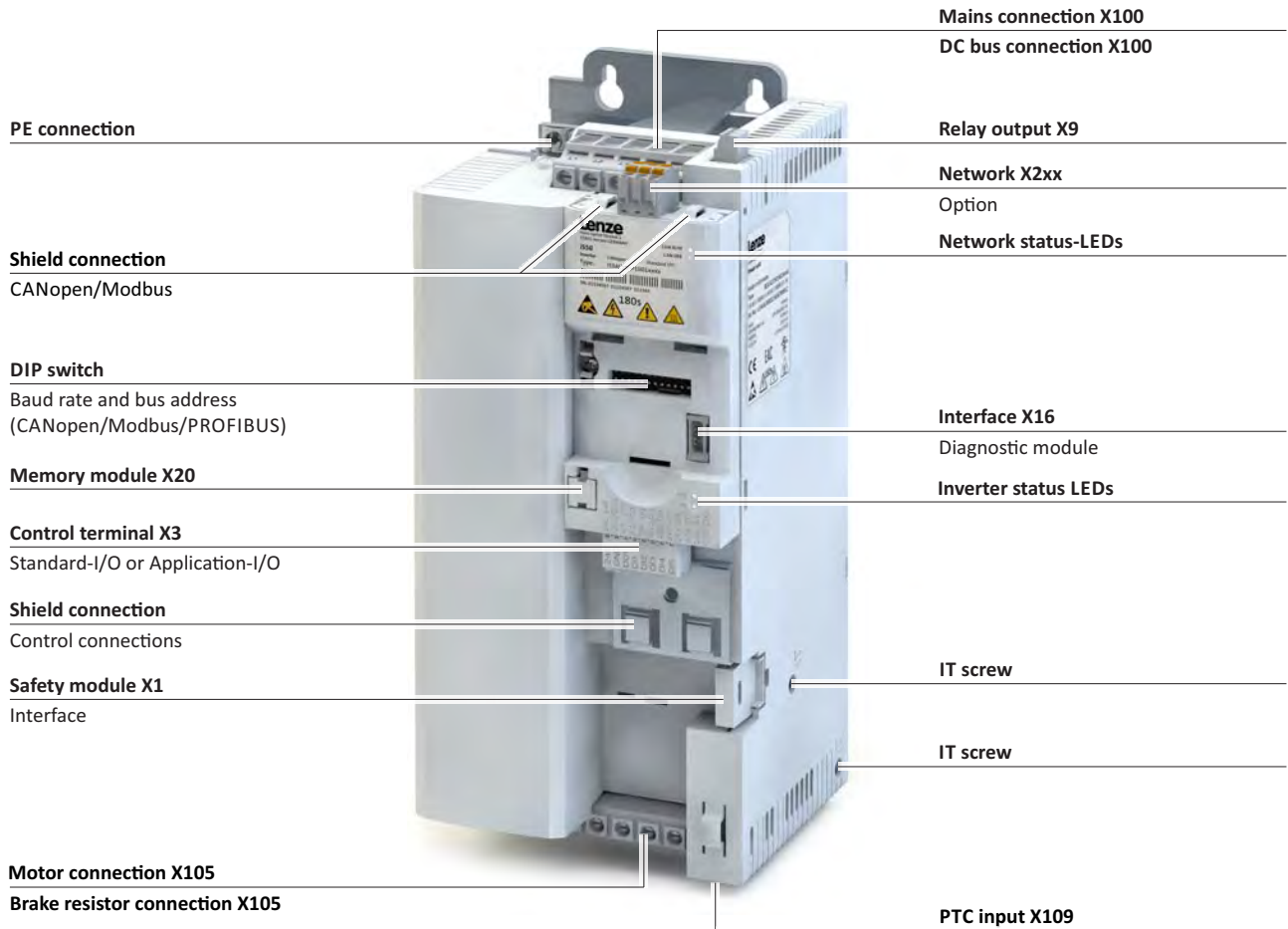

Terminal designations X... see connection plans

## Position and meaning of the nameplates

Complete inverter		Inverter consisting of components	
①	Technical data of the power unit	①	Technical data of the component
④	Technical data of the control unit Type and serial number of the inverter	②	Serial number of the component
		③	Technical data and serial number of the safety module





## The modular inverter system

### The concept

Thanks to its flexible concept and modular structure consisting of power unit, control unit and safety module, the inverter can be optimally adapted to the application.

This provides the user with a flexible logistics concept - ordered as a complete inverter or single components.

Complete inverter	Inverter consisting of components
	 <p>Control unit</p> <p>Power unit</p> <p>Safety module</p>

### Power unit

The power unit is the power section of the inverter.

It is available in a power range from 0.25 kW to 45 kW.

### Control unit

The control unit is the open and closed-loop control unit.

It contains I/O connections, networks, the interface for diagnostic modules, LED status displays and the memory module.

### Safety module

The safety module is available with the functional safety STO (Safe torque off).

# Inverter

Product information  
The modular inverter system









## Topologies / network

The inverters can be equipped with different fieldbus networks.

The topologies and protocols typical for the prevailing networks are supported.

Currently available networks:

	<p>CANopen® is a communication protocol based on CAN. CANopen® is a registered community trademark of the CAN user organisation Cia® (CAN in Automation e. V.). The EDS device description files for CANopen can be found here: <a href="http://www.lenze.com/application-knowledge-base/artikel/200413930/0/">http://www.lenze.com/application-knowledge-base/artikel/200413930/0/</a></p>
	<p>The Modbus protocol is an open communication protocol based on a client/server architecture and developed for the communication with programmable logic controllers. The further development is carried out by the international user organisation Modbus Organization, USA.</p>
	<p>PROFIBUS® (Process Field Bus) is a widely-used fieldbus system for the automation of machines and production plants. PROFIBUS® is a registered trademark and patented technology licensed by the PROFIBUS &amp; PROFINET International (PI) user organisation. The GSE device description files for PROFIBUS can be found here: <a href="http://www.lenze.com/application-knowledge-base/artikel/200412329/0/">http://www.lenze.com/application-knowledge-base/artikel/200412329/0/</a></p>
	<p>EtherCAT® (Ethernet for Controller and Automation Technology) is an Ethernet-based fieldbus system which fulfils the application profile for industrial realtime systems EtherCAT® is a registered trademark and patented technology, licensed by Beckhoff Automation GmbH, Germany. The XML device description files for EtherCAT can be found here: <a href="http://www.lenze.com/application-knowledge-base/artikel/200800381/0/">http://www.lenze.com/application-knowledge-base/artikel/200800381/0/</a></p>
	<p>EtherNet/IP™ (EtherNet Industrial Protocol) is a fieldbus system based on Ethernet which uses the Common Industrial Protocol™ (CIP™) for data exchange. EtherNet/IP™ and Common Industrial Protocol™ (CIP™) are trademarks and patented technologies, licensed by the user organisation ODVA (Open DeviceNet Vendor Association), USA. The EDS device description files for EtherNet/IP can be found here: <a href="http://www.lenze.com/application-knowledge-base/artikel/201207514/0/">http://www.lenze.com/application-knowledge-base/artikel/201207514/0/</a></p>
	<p>PROFINET® (Process Field Network) is a real-time capable fieldbus system based on Ethernet. PROFINET® is a registered trademark and patented technology licensed by the PROFIBUS &amp; PROFINET International (PI) user organisation. The GSDML device description files for PROFINET can be found here: <a href="http://www.lenze.com/application-knowledge-base/artikel/200804173/0/">http://www.lenze.com/application-knowledge-base/artikel/200804173/0/</a></p>

More information on the supported networks can be found at <http://www.lenze.com>





## Ways of commissioning

There are three methods to commission the inverter quickly and easily.

Thanks to Lenze's engineering philosophy, the high functionality is still easy to grasp. Parameterisation and set-up are impressive thanks to clear structure and simple dialogues, leading to the desired outcome quickly and reliably.

- Keypad

If it's only a matter of setting a few key parameters such as acceleration and deceleration time, this can be done quickly on the keypad.



- Smart-KeyPad-App for Android

The intuitive smartphone app enables adjustment to a simple application such as a conveyor belt.



- »EASY Starter«

If functions such as the holding brake control or sequence control need to be set, it's best to use the »EASY Starter« engineering tool.



# Inverter

Product information  
Functions



## Functions

### Overview

With regard to their functionality, the inverters i550 are adapted to extensive applications. This is also reflected in the total scope of the products.

Functions	
Motor control	Monitoring
V/f characteristic control linear/square-law (VFC plus)	Short circuit
Sensorless vector control (SLVC)	Earth fault
Energy saving function (VFCeco)	Device overload monitoring ( $i^*t$ )
Servo control for asynchronous motors (SC ASM)	Motor overload monitoring ( $i^2*t$ )
Motor functions	Mains phase failure
Flying restart circuit	Stalling protection
Slip compensation	Motor current limit
DC braking	Maximum torque
Oscillation damping	Ultimate motor current
Skip frequencies	Motor speed monitoring
Automatic identification of the motor data	Load loss detection
Brake energy management	Motor temperature monitoring (PTC and thermal contact)
Holding brake control	Diagnostics
Voltage add – function	Error history buffer
Rotational Energy Ride Through (RERT)	Logbook
Speed feedback (HTL encoder)	LED status displays
Brake resistor control (brake chopper integrated)	Keypad language selection German, English
DC-bus connection (400V devices)	Network
Application functions	CANopen
Process controller	Modbus
Process controller - idle state and rinse function	PROFIBUS
Freely assignable favorite menu	EtherCAT
Parameter change-over	EtherNet/IP
S-shaped ramps for smooth acceleration	PROFINET
Motor potentiometer	Safety functions
Flexible I/O configuration	STO (Safe torque off)
Access protection	
Automatic restart	
OEM parameter set	

### Motor control types

The following table contains the possible control types with Lenze motors.

Motors	V/f characteristic control VFCplus	Sensorless vector control SLVC	ASM servo control SC ASM
Three-phase AC motors			
MD	•	•	•
MF	•	•	•
mH	•	•	•
m500	•	•	•



## Features

### Motor setting range

#### Rated point 120 Hz



Only possible with Lenze MF motors.

The rated motor torque is available up to 120 Hz.

Compared to the 50-Hz operation, the setting range increases by 2.5 times.

It is quite simply not possible for a drive to be operated any more efficiently in a machine.

#### V/f at 120 Hz

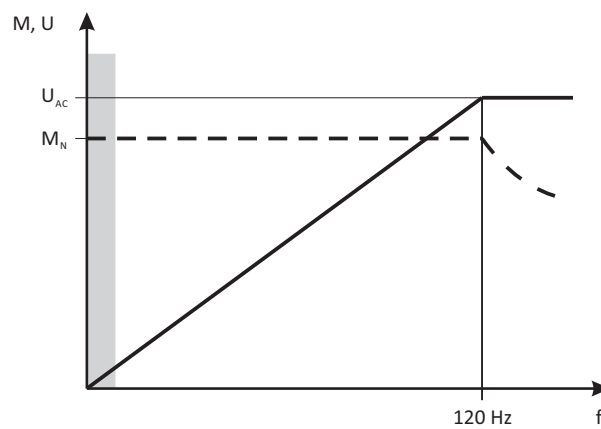

V Voltage  
M Torque  
f Frequency

$U_{AC}$  Mains voltage  
 $M_{rated}$  Rated torque

# Inverter

Product information  
Features



## Rated point 87 Hz

The rated motor torque is available up to 87 Hz.

Compared to the 50-Hz operation, the setting range increases by 1.4 times.

For this purpose, a motor with 230/400 V in star connection is driven by a 400-V inverter.

The inverter must be dimensioned for a rated motor current of 230 V.

### V/f at 87 Hz

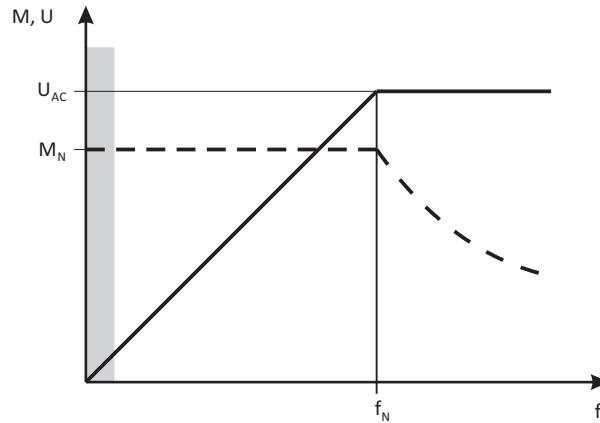

V Voltage  
M Torque  
f Frequency

$U_{AC}$  Mains voltage  
 $M_{rated}$  Rated torque  
 $f_{rated}$  Rated frequency

## Rated point 50 Hz

The rated motor torque is available up to 50 Hz.

### V/f at 50 Hz

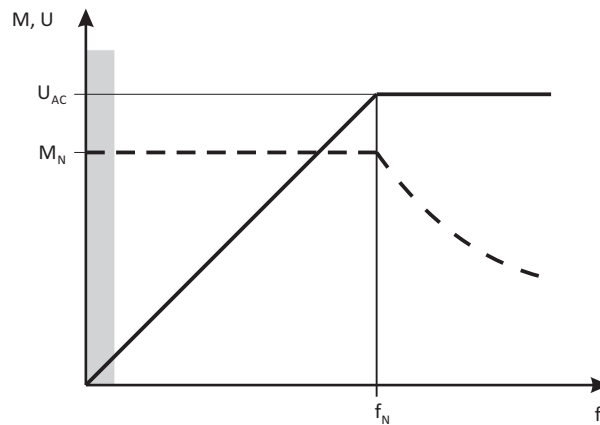

V Voltage  
M Torque  
f Frequency

$U_{AC}$  Mains voltage  
 $M_{rated}$  Rated torque  
 $f_{rated}$  Rated frequency



**The name of the product**

When the technical data of the different versions were listed, the product name was entered because it is easier to read than the individual type code of the product. The product name is also used for the accessories. The assignment of product name and order code can be found in the Order chapter.

The simple naming makes the selection of the products easier.

The product name contains the power in kW, mains voltage class 230 V/ 400 V and the number of phases.

The 1/3-phase inverters are marked at the end with "-2".

"C" marks the "Cabinet" version = inverter for the installation into the control cabinet.

Inverter series	Version	Rated power	Rated mains voltage	Number of phases	Inverter
		kW	V		
i550	C	0.25	230	1	i550-C0.25/230-1
		0.37			i550-C0.37/230-1
		0.55			i550-C0.55/230-1
		0.75			i550-C0.75/230-1
		1.1			i550-C1.1/230-1
		1.5			i550-C1.5/230-1
		2.2			i550-C2.2/230-1
		0.25	230/240	1/3	i550-C0.25/230-2
		0.37			i550-C0.37/230-2
		0.55			i550-C0.55/230-2
		0.75			i550-C0.75/230-2
		1.1			i550-C1.1/230-2
		1.5			i550-C1.5/230-2
		2.2			i550-C2.2/230-2
		0.37	400/480	3	i550-C0.37/400-3
		0.55			i550-C0.55/400-3
		0.75			i550-C0.75/400-3
		1.1			i550-C1.1/400-3
		1.5			i550-C1.5/400-3
		2.2			i550-C2.2/400-3
		3			i550-C3.0/400-3
		4			i550-C4.0/400-3
		5.5			i550-C5.5/400-3
		7.5			i550-C7.5/400-3
		11			i550-C11/400-3
		15			i550-C15/400-3
		18.5			i550-C18/400-3
22	i550-C22/400-3				
30	i550-C30/400-3				
37	i550-C37/400-3				
45	i550-C45/400-3				

# Inverter

Project planning  
Procedure of an inverter configuration process



## Project planning

### Procedure of an inverter configuration process

#### Dimensioning

##### 3 methods for dimensioning

**Fast:** Selection of the inverter based on the motor data of a 4-pole asynchronous motor.

**Detailed:** In order to optimise the selection of the inverter and all drive components, it is worth to execute the detailed system dimensioning based on the physical requirements of the application. For this purpose, Lenze provides the «Drive Solution Designer» (DSD) design program.

**Manual:** The following chapter guides you step by step to the selection of a drive system.

#### Workflow of a configuration process

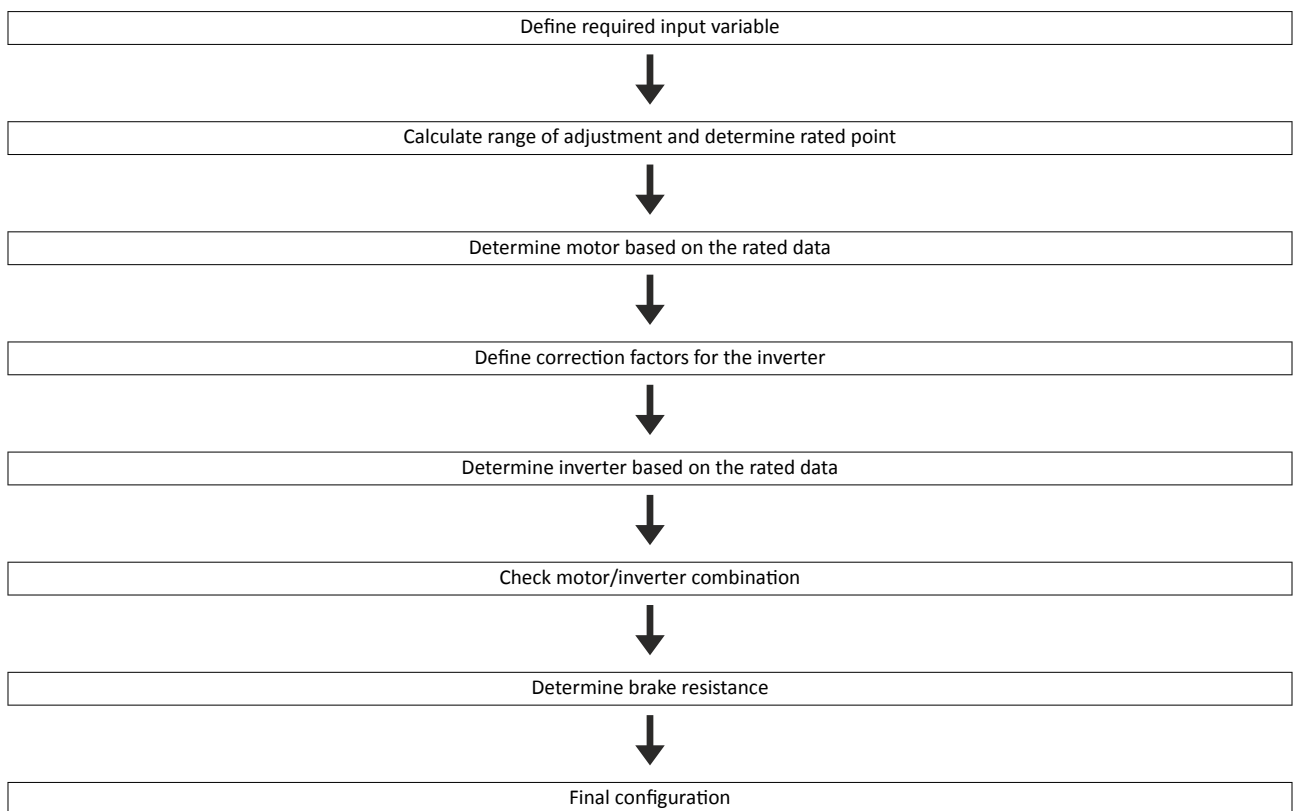

#### Define required input variables

Operating mode			S1 or S6
Max. load torque	$M_{L,max}$	Nm	
Max. load speed	$n_{L,max}$	rpm	
Min. load speed	$n_{L,min}$	rpm	
Site altitude	H	m	
Temperature in the control cabinet	$T_U$	°C	



### Calculate range of adjustment and determine rated point

	Calculation
Setting range	$V = \frac{n_{L,max}}{n_{L,min}}$

	Setting range	Rated point
Motor with integral fan	≤ 2.50 (20 - 50 Hz)	50 Hz
	≤ 4.35 (20 - 87Hz)	87 Hz
	≤ 6 (20 - 120Hz)	120 Hz
Motor with blower	≤ 10.0 (5 - 50 Hz)	50 Hz
Motor with integral fan (reduced torque)	≤ 17.4 (5 - 87Hz)	87 Hz
	≤ 24 (5 - 120Hz)	120 Hz

### Determine motor based on the rated data

			Check
Rated torque			
Operating mode S1	$M_{rated}$	Nm	$M_N \geq \frac{M_{L,max}}{T_{H,Mot} \times T_{U,Mot}}$
Operating mode S6	$M_{rated}$	Nm	$M_N \geq \frac{M_{L,max}}{2 \times T_{H,Mot} \times T_{U,Mot}}$
Rated speed	$n_{rated}$	rpm	$n_{rated} \geq n_{L,max}$  $\frac{n_n}{V} \leq n_{L,min}$

			Note
Rated torque	$M_{rated}$	Nm	→ Rated motor data
Rated speed	$n_{rated}$	rpm	
Rated point at		Hz	→ setting range
Power factor	$\cos \varphi$		→ Rated motor data
Rated current	$I_{N,MOT}$	A	
Rated power	$P_{rated}$	kW	
Correction factor - site altitude	$T_{H,MOT}$		→ Technical motor data
Correction factor - ambient temperature	$T_{U,MOT}$		
Select motor			

# Inverter

Project planning  
 Procedure of an inverter configuration process



## Correction factors for the inverter

Site altitude Amsl					
H	[m]	≤ 1000	≤ 2000	≤ 3000	≤ 4000
$k_{H,INV}$		1	0,95	0,90	0,80

Temperature in the control cabinet					
$T_U$	[°C]	≤ 45	≤ 50	≤ 55	
$k_{TU,INV}$		1	0,875	0,750	

## Determine inverter based on the rated data

Output current				Check
Continuous operation	$I_{out}$	A		$I_{out} \geq I_{N,Mot} / (k_{H,INV} \times k_{TU,INV})$
Overcurrent operation cycle 15 s	$I_{out}$	A		$I_{out} \geq I_{N,Mot} \times 2 / (k_{H,INV} \times k_{TU,INV})$
Overcurrent operation cycle 180 s	$I_{out}$	A		$I_{out} \geq I_{N,Mot} \times 1.5 / (k_{H,INV} \times k_{TU,INV})$

## Check motor/inverter combination

			Calculation
Motor torque	M	Nm	$M = \sqrt{\left(\frac{I_{out,INV}}{I_{N,MOT}}\right)^2 - (1 - \cos^2\varphi)} \times \frac{M_N}{\cos\varphi}$

			Check
Overload capacity of the inverter			$\frac{M_{L,max}}{M} \leq 1.5$





### Braking operation without additional measures

To decelerate small masses, the "DC injection brake DCB" function can be parameterised. DC-injection braking enables a quick deceleration of the drive to standstill without the need for an external brake resistor.

- A code can be used to select the braking current.
- The maximum braking torque to be realised by the DC braking current amounts to approx. 20 ... 30 % of the rated motor torque. It is lower compared to braking action in generator mode with external brake resistor.
- Automatic DC-injection braking (Auto-DCB) improves the starting performance of the motor when the operation mode without speed feedback is used.

### Braking operation with external brake resistor

To decelerate greater moments of inertia or with a longer operation in generator mode an external brake resistor is required. It converts braking energy into heat.

The brake resistor is connected if the DC-bus voltage exceeds the switching threshold. überschreitet. This prevents the controller from setting pulse inhibit through the "Overvoltage" fault and the drive from coasting. The external brake resistor serves to control the braking process at any time.

The brake chopper integrated in the controller connects the external brake resistor.

### Determine brake resistance

			Application	
			With active load	With passive load
Rated power	$P_{\text{rated}}$	kW	$P_N \geq P_{\text{max}} \times \eta_e \times \eta_m \times \frac{t_1}{t_z}$	$P_N \geq \frac{P_{\text{max}} \times \eta_e \times \eta_m \times t_1}{2} \times \frac{1}{t_z}$
Thermal capacity	$C_{\text{th}}$	kWs	$C_{\text{th}} \geq P_{\text{max}} \times \eta_e \times \eta_m \times t_1$	$C_{\text{th}} \geq \frac{P_{\text{max}} \times \eta_e \times \eta_m \times t_1}{2}$
Rated resistance	$R_{\text{rated}}$	$\Omega$	$R_N \geq \frac{U_{\text{DC}}^2}{P_{\text{max}} \times \eta_e \times \eta_m}$	

- Active load      Can start to move independent of the drive (e.g. unwinder)
- Passive load    Can stop independent of the drive (e.g. horizontal travelling drives, centrifuges, fans)
- $U_{\text{DC}}$  [V]      Switching threshold - brake chopper
- $P_{\text{max}}$  [W]      Maximum occurring braking power
- $\eta_e$               Electrical efficiency
- $\eta_m$               Mechanical efficiency
- $t_1$  [s]           Braking time
- $t_z$  [s]           Cycle time = time between two successive braking processes ( $t_1$  + dead time)

### Final configuration

Product extensions and accessories can be found here:

- [Product extensions](#) 📄 72
- [Accessories](#) 📄 90

# Inverter

Project planning

Procedure of an inverter configuration process



---

## Operation in motor and generator mode

The energy analysis differs between operation in motor mode and generator mode.

During operation in motor mode, the energy flows from the supplying mains via the inverter to the motor which converts electrical energy into mechanical energy (e. g. for lifting a load).

During operation in generator mode, the energy flows back from the motor to the inverter. The motor converts the mechanical energy into electrical energy - it acts as a generator (e. g. when lowering a load).

The drive brakes the load in a controlled manner.

The energy recovery causes a rise in the DC-bus voltage. If this voltage exceeds an upper limit, the output stage of the inverter will be blocked to prevent the device from being destroyed.

The drive coasts until the DC-bus voltage reaches the permissible value range again.

In order that the excessive energy can be dissipated, a brake resistor or a regenerative module is required.



**Overcurrent operation**

The inverters can be driven at higher amperages beyond the rated current if the duration of this overcurrent operation is time limited.

Two utilisation cycles of 15 s and 180 s are defined. Within these utilisation cycles, an overcurrent is possible for a certain time if afterwards an accordingly long recovery phase takes place.

**Cycle 15 s**

During this operation, the inverter may be loaded for 3 s with 200 % of the rated current if afterwards a recovery time of 12 s with max. 75 % of the rated current is observed. A cycle corresponds to 15 s.

**Cycle 180 s**

During this operation, the inverter may be loaded for 60 s with 150 % of the rated current if afterwards a recovery time of 120 s with max. 75 % of the rated current is observed. A cycle corresponds to 180 s.

The monitoring of the device utilisation (Ixt) causes the set error response if one of the two utilisation values exceeds the threshold of 100 %.



The maximum output currents correspond to the switching frequencies and the overload behaviour of the inverters are given in the rated data.

In case of speed frequencies < 10 Hz, the overload behaviour may be reduced.

The graphics shows a cycle. The basic conditions given in the table (graphics field highlighted in grey) have to be complied with in order that the inverter will not be overloaded. Both cycles can be combined with each other.

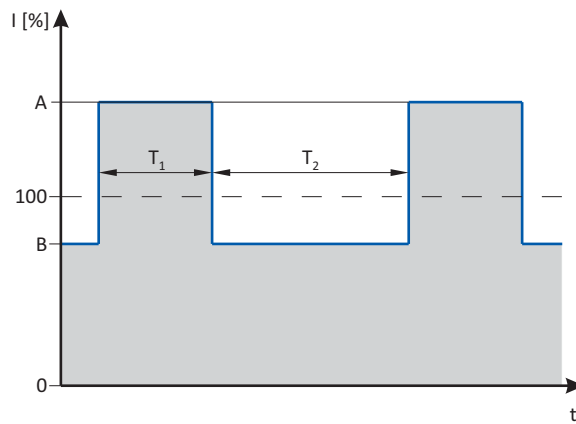

	<b>Max. output current</b>	<b>Max. overload time</b>	<b>Max. output current during the recovery time</b>	<b>Min. recovery time</b>
	<b>A</b>	<b>T<sub>1</sub></b>	<b>B</b>	<b>T<sub>2</sub></b>
	%	s	%	s
Cycle 15 s	200	3	75	12
Cycle 180 s	150	60	75	120

# Inverter

Project planning  
General safety instructions



---

## General safety instructions

### Application as directed

- The product must only be operated under the operating conditions prescribed in this documentation.
- The product meets the protection requirements of 2014/35/EU: Low-Voltage Directive.
- The product is not a machine in terms of 2006/42/EC: Machinery Directive.
- Commissioning or starting the operation as directed of a machine with the product is not permitted until it has been ensured that the machine meets the regulations of the EC Directive 2006/42/EC: Machinery Directive; observe EN 60204-1.
- Commissioning or starting the operation as directed is only allowed when there is compliance with the EMC Directive 2014/30/EU.
- The harmonised standard EN 61800-5-1 is used for the inverters.
- The product is not a household appliance, but is only designed as component for commercial or professional use in terms of EN 61000-3-2.
- In accordance with EN 61800-3, the product can be used in drive systems that have to comply with the categories given in the technical data.

In residential areas, the product may cause EMC interferences. The operator is responsible for taking interference suppression measures.



## Handling

### Transport, storage

Observe the notes regarding transport, storage and correct handling. Ensure proper handling and avoid mechanical stress. Do not bend any components and do not change any insulation distances during transport or handling. Do not touch any electronic components and contacts. Inverters contain electrostatically sensitive components which can easily be damaged by inappropriate handling. Do not damage or destroy any electrical components since thereby your health could be endangered!

### Installation

The technical data and supply conditions can be obtained from the nameplate and the documentation. They must be strictly observed.

The inverters have to be installed and cooled according to the regulations given in the corresponding documentation. Observe the climatic conditions according to the technical data. The ambient air must not exceed the degree of pollution 2 according to EN 61800-5-1.

### Electrical connection

When working on live inverters, observe the applicable national regulations for the prevention of accidents.

The electrical installation must be carried out according to the appropriate regulations (e. g. cable cross-sections, fuses, PE connection). Additional information can be obtained from the documentation.

This documentation contains information on installation in compliance with EMC (shielding, earthing, filter, and cables). These notes must also be observed for CE-marked inverters. The manufacturer of the system is responsible for compliance with the limit values demanded by EMC legislation. The inverters must be installed in housings (e. g. control cabinets) to meet the limit values for radio interferences valid at the site of installation. The housings must enable an EMC-compliant installation. Observe in particular that e. g. the control cabinet doors have a circumferential metal connection to the housing. Reduce housing openings and cutouts to a minimum.

Inverters may cause a DC current in the PE conductor. If a residual current device (RCD) is used for protection against direct or indirect contact for an inverter with three-phase supply, only a residual current device (RCD) of type B is permissible on the supply side of the inverter. If the inverter has a single-phase supply, a residual current device (RCD) of type A is also permissible. Apart from using a residual current device (RCD), other protective measures can be taken as well, e. g. electrical isolation by double or reinforced insulation or isolation from the supply system by means of a transformer.

### Operation

If necessary, systems including inverters must be equipped with additional monitoring and protection devices according to the valid safety regulations.

After the inverter has been disconnected from the supply voltage, all live components and power terminals must not be touched immediately because capacitors can still be charged. Please observe the corresponding stickers on the inverter.

All protection covers and doors must be shut during operation.

You may adapt the inverters to your application by parameter setting within the limits available. For this, observe the notes in the documentation.

# Inverter

Project planning  
General safety instructions



## Safety functions

Certain inverter versions support safety functions (e. g. "safe torque off", formerly "safe standstill") according to the requirements of the EC Machinery Directive 2006/42/EC. The notes on the integrated safety provided in this documentation must be observed.

## Maintenance and servicing

The inverters do not require any maintenance if the prescribed operating conditions are observed.

## Disposal

In accordance with the current provisions, inverters and accessories have to be disposed of by means of professional recycling. Inverters contain recyclable raw material such as metal, plastics and electronic components.

## Residual hazards

Even if given notes are observed and protective measures are taken, there may be residual risks. Thus, observe the summarised measures.

## Protection of persons

Before working on the inverter, check if no voltage is applied to the power terminals.

- Depending on the device, the power terminals U, V, W, +UG, -UG, Rb1 and Rb2 remain live for up to 3 ... 20 minutes.
- The power terminals L1, L2, L3, U, V, W, +UG, -UG, Rb1 and Rb2 remain live even when the motor is stopped.

## Device protection

- Connect/disconnect all pluggable terminals only in deenergised condition.
- Detach the inverters from the installation, e. g. from the rear panel of the control cabinet, only in deenergised condition.

## Motor protection

With some settings of the inverter, the connected motor can be overheated.

- E. g. by longer operation of self-ventilated motors at low speed.
- E. g. by longer operation of the DC-injection brake.

## Protection of the machine/system

Drives can reach dangerous overspeeds.

- E. g. by setting high output frequencies in connection with motors and machines not suitable for this purpose.
- The inverters do not provide protection against such operating conditions. For this purpose, use additional components.

Switch contactors in the motor cable only if the controller is inhibited.

- Switching while the inverter is enabled is only permissible if no monitoring functions are activated.

## Parameter set transfer

During the parameter set transfer, control terminals of the inverters can adopt undefined states.

- Thus, the control terminal of the digital input signals have to be removed before the transfer.
- This ensures that the inverter is inhibited. The control terminals are in a defined state.



## Control cabinet structure

### Control cabinet requirements

- Support of conductive mounting plates
- Support of the structure with mounting rails
- Division into power and control areas
- Protection against contact with dangerous voltages
- Protection against electromagnetic interferences
- Protection against dust and water
- Protection against overheating
- Protection against special ambient conditions
- Possibility for direct side-by-side mounting of more control cabinets for extensive installations

### Mounting plate requirements

- The mounting plate must be electrically conductive.
  - Use zinc-coated mounting plates or mounting plates made of V2A.
  - Varnished mounting plates are unsuitable, even if the varnish is removed from the contact surfaces.
- When using several mounting plates, make a conductive connection over a large surface (e. g. using grounding strips).

### Arrangement of components

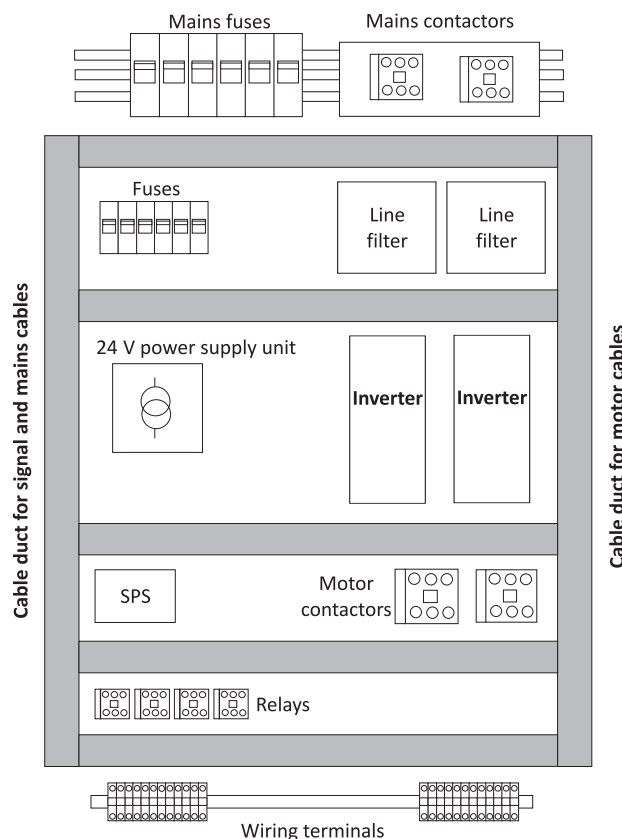

*Fig. 1: Example for the ideal arrangement of components in the control cabinet*

### Shielding

The structure in the control cabinet must support the EMC-compliant wiring with shielded cables.

- Please use highly conductive shield connections.
- Connect the housing with shielding effect to the grounded mounting plate with a surface as large as possible, e. g. of inverters and RFI filters.
- Use central earthing points.

# Inverter

Project planning  
Control cabinet structure



## EMC-compliant wiring

EMC-compliant installation or structure of a CE-typical drive system

Observing the following explanations will make the planning of an EMC-compliant installation easier for you.

### Cable types

- You must observe the regulations for minimum cross-sections of PE conductors. The cross-section of the PE conductor must be at least as large as the cross-section of the power connections.
- The cables used must correspond to the required approvals at the location (e. g. UL).

### Mains connection, DC supply

- Inverters, mains chokes, or mains filters may only be connected to the mains via unshielded single cores or unshielded cables.
- When a mains filter or RFI filter is used, shield the cable between mains filter or RFI filter and inverter if its length exceeds 300 mm. Unshielded cores must be twisted.
- In DC-bus operation or DC supply, use shielded cables.
- The cable cross-section must be dimensioned for the assigned fusing. Observe national and regional regulations.

### Motor cable

- Only use shielded motor cables with braids made of tinned or nickel-plated copper. Shields made of steel braids are not suitable.
  - The overlap rate of the braid must be at least 70 % with an overlap angle of 90 °.
- The cables used must correspond to the requirements at the location (e. g. EN 60204-1).
- Shield the cable for motor temperature monitoring (PTC or thermal contact) and install it separately from the motor cable.
  - In Lenze system cables, the cable for brake control is integrated into the motor cable. If this cable is not required for brake control, it can also be used to connect the motor temperature monitoring up to a length of 50 m.
- Connect the shield with a large surface and fix it with metal cable binders or conductive clamp. The following is suitable for the connection of the shield:
  - The mounting plate
  - A central grounding rail
  - A device shield sheet, optional where necessary
- This is optimal:
  - The motor cable is separated from the mains cables and control cables.
  - The motor cable only crosses mains cables and control cables at right angles.
  - The motor cable is not interrupted.
- If the motor cable must be opened all the same (e. g. by chokes, contactors, or terminals):
  - The unshielded cable ends must not be longer than 100 mm (depending on the cable cross-section).
  - Install chokes, contactors, terminals etc. spatially separated from other components (with a minimum distance of 100 mm).
  - Install the shield of the motor cable directly before and behind the point of separation to the mounting plate with a large surface.
- Connect the shield with a large surface to PE in the terminal box of the motor at the motor housing.
  - Metal EMC cable glands at the motor terminal box ensure a large surface connection of the shield with the motor housing.





## Control cables

- Control cables for digital signals with a maximum length of 5 m do not need to be shielded. The formation of induction-sensitive loops must be excluded.
- Control cables for digital signals with a minimum length of 5 m up to a maximum length of 30 m do not need to be shielded but may be twisted.
- Control cables for digital signals with a minimum length of 30 m must always be shielded.
  - In case of cables for digital cables, connect the shield on both sides.
- Control cables must be always shielded to minimise interference injections.
  - In case of cables for analog signals, connect the shield on one side of the inverter.
- The shield connections of the control cables must be at least 50 mm away from the shield connections of the motor cables and DC cables.

## Network cables

Cables have to comply with the specifications and requirements of the used network or the used fieldbus. In typical systems, a standard shielding of the cables is sufficient for an EMC-compliant wiring.

In environments with very strong interferences, the EMC immunity can be improved by an additional earthing of the shielding on both sides.

Please note the following:

1. Remove the plastic coating of the cable over a length of 2 cm.
2. Connect the shielding to the shield support of the standard device.

Matching accessories makes effective shielding easier.

- Shield connecting sheets
- Shield clips/shield clamps
- Metallic cable ties

## Earthing concept

- The earthing system should be configured with a star-topology.
- Connect all components (inverters, filters, chokes) to a central earthing point (PE rail).
- Comply with the corresponding minimum cross-sections of the cables.
- When using several mounting plates, make a conductive connection over a large surface (e. g. using grounding strips).

# Inverter

Project planning  
Control cabinet structure



---

## Cable duct route

### Cable guide

#### Wiring on the supply side

- Inverters, mains chokes or RFI filters may be connected to the mains via single cores or unshielded cables.
- When a mains filter or RFI filter is used, shield the cable between mains filter or RFI filter and inverter if its length exceeds 300 mm. Unshielded cores must be twisted.
- The cable cross-section must be dimensioned for the assigned fusing.

#### Wiring of DC supply

- In DC-bus operation or DC supply, use shielded cables.
- The cable cross-section must be dimensioned for the assigned fusing (observe national and regional regulations).

#### Wiring on the motor side

- Exclusively use shielded and low-capacitance motor cables.
- Do not integrate any further cable into the motor cable (e. g. for blowers etc.).
- Shield the supply cable for temperature monitoring of the motor (PTC or thermostat) and install it separately from the motor cable.
- In Lenze system cables, you can integrate the supply cable for temperature monitoring of the motor into the motor cable.

#### Considering the following during the planning and execution phase

- Always install cables close to the mounting plate (reference potential), as freely suspended cables act like aerials.
- Use separated cable channels for motor cables and control cables. Do not mix up different cable types in one cable channel.
- The motor cables are optimally installed if they are separated from the mains cables and control cables.
- The motor cable is optimally installed if it crosses mains cables and control cables at right angles.
- Lead the cables to the terminals in a straight line (avoid tangles of cables).
- Minimise coupling capacities and coupling inductances by avoiding unnecessary cable lengths and reserve loops.
- Short-circuit unused cores to the reference potential.
- Install the cables of a 24 V DC supply (positive and negative cable) close to each other over the entire length to avoid loops.

#### Installation of cables outside the control cabinet

- In the case of greater cable lengths, a greater cable distance between the cables is required.
- In the case of parallel routing (cable trays) of cables with different types of signals, the degree of interference can be minimised by using a metallic cable separator or isolated cable ducts.



## Technical data

### Standards and operating conditions

Conformities		
CE	2014/35/EU	Low-Voltage Directive
	2014/30/EU	EMC Directive (reference: CE-typical drive system)
EAC	TR TC 004/2011	Eurasian conformity: safety of low voltage equipment
	TP TC 020/2011	Eurasian conformity: electromagnetic compatibility of technical means
RoHS 2	2011/65/EU	Restrictions for the use of specific hazardous materials in electric and electronic devices
Approvals		
UL	UL 61800-5-1	for USA and Canada (requirements of the CSA 22.2 No. 274)
		0.25 kW ... 22 kW (30 kW ... 45 kW in preparation)
Energy efficiency		
Class IE2	EN 50598-2	Reference: Lenze setting (switching frequency 8 kHz variable)
Degree of protection		
IP20	EN 60529	
Type 1	NEMA 250	Protection against contact
Open type		only in UL-approved systems
Insulation resistance		
Overvoltage category III	EN 61800-5-1	0 ... 2000 m a.m.s.l.
Overvoltage category II		above 2000 m a.m.s.l.
Control circuit isolation		
Safe mains isolation by double/reinforced insulation	EN 61800-5-1	
Protective measures against		
Short circuit		
Earth fault		Earth fault strength depends on the operating status
Overvoltage		
Motor stalling		
Motor overtemperature		PTC or thermal contact, I <sup>2</sup> t monitoring
Leakage current		
> 3.5 mA AC, > 10 mA DC	EN 61800-5-1	Observe regulations and safety instructions!
Mains switching		
3-time mains switching in 1 min		Cyclic, without any restrictions
Starting current		
≤ 3 x rated mains current		
Mains systems		
TT		Voltage to earth/ground: max. 300 V
TN		
IT		Apply the measures described for IT systems!
		IT systems are not relevant for UL-approved systems
Operation on public supply systems		
Implement measures to limit the radio interference to be expected:		The machine or plant manufacturer is responsible for compliance with the requirements for the machine/plant!
< 1 kW: with mains choke	EN 61000-3-2	
> 1 kW at mains current ≤ 16 A: without additional measures		
Mains current > 16 A: with mains choke or mains filter, with dimensioning for rated power. R <sub>sce</sub> ≥ 120 is to be met.	EN 61000-3-12	R <sub>sce</sub> : short-circuit power ratio at the connection point of the machine/plant to the public network.
Requirements to the shielded motor cable		
Capacitance per unit length		
C-core-core/C-core-shield < 75/150 pF/m		≤ 2.5 mm <sup>2</sup> / AWG 14
C-core-core/C-core-shield < 150/300 pF/m		≥ 4 mm <sup>2</sup> / AWG 12
Electric strength		

# Inverter

Technical data

Standards and operating conditions



U <sub>0</sub> /U = 0.6/1.0 kV		U <sub>0</sub> = r.m.s. value external conductor to PE
U ≥ 600 V	UL	U = r.m.s. value external conductor/external conductor
Climate		
1K3 (-25 ... +60 °C)	EN 60721-3-1	Storage
2K3 (-25 ... +70 °C)	EN 60721-3-2	Transport
3K3 (-10 ... +55 °C)	EN 60721-3-3	Operation
		Operation at a switching frequency of 2 or 4 kHz: above +45°C, reduce rated output current by 2.5 %/°C
		Operation at a switching frequency of 8 or 16 kHz: above +40°C, reduce rated output current by 2.5 %/°C
Site altitude		
0 ... 1000 m a.m.s.l.		
1000 ... 4000 m a.m.s.l.		Reduce rated output current by 5 %/1000 m
Pollution		
Degree of pollution 2	EN 61800-5-1	
Vibration resistance		
Transport		
2M2 (sine, shock)	EN 60721-3-2	
Operation		
Amplitude 1 mm	Germanischer Lloyd	5 ... 13.2 Hz
Acceleration resistant up to 0.7 g		13.2 ... 100 Hz
Amplitude 0.075 mm	EN 61800-5-1	10 ... 57 Hz
Acceleration resistant up to 1 g		57 ... 150 Hz
Noise emission		
Category C1	EN 61800-3	Type-dependent, for motor cable lengths see rated data
Category C2		
Noise immunity		
Meets requirement in compliance with	EN 61800-3	

## Electrical supply conditions

The connection to different supply forms enables a worldwide application of the inverters.

The following is supported:

- [1-phase mains connection 230 V](#) 37
- [1/3-phase mains connection 230/240 V](#) 41
- [3-phase mains connection 400 V](#) 45
- [3-phase mains connection 480 V](#) 55



**1-phase mains connection 230 V**

**Rated data**

The output currents apply to these operating conditions:

- At a switching frequency of 2 kHz or 4 kHz: Max. ambient temperature 45°C.
- At a switching frequency of 8 kHz or 16 kHz: Max. ambient temperature 40 °C.

Inverter		i550-C0.25/230-1	i550-C0.37/230-1	i550-C0.55/230-1	i550-C0.75/230-1
<b>Rated power</b>	<b>kW</b>	<b>0.25</b>	<b>0.37</b>	<b>0.55</b>	<b>0.75</b>
Mains voltage range		1/N/PE AC 170 V ... 264 V, 45 Hz ... 65 Hz			
Rated mains current					
without mains choke	A	4	5.7	7.6	10
with mains choke	A	3.6	4.8	7.1	8.8
Output current					
2 kHz	A	-	-	3.2	4.2
4 kHz	A	1.7	2.4	3.2	4.2
8 kHz	A	1.7	2.4	3.2	4.2
16 kHz	A	1.1	1.6	2.1	2.8
Power loss	W	15	20	25	33
Overcurrent cycle 180 s					
Max. output current	A	2.55	3.6	4.8	6.3
Overload time	s	60	60	60	60
Recovery time	s	120	120	120	120
Max. output current during the recovery time	A	1.28	1.8	2.4	3.15
Overcurrent cycle 15 s					
Max. output current	A	3.4	4.8	6.4	8.4
Overload time	s	3	3	3	3
Recovery time	s	12	12	12	12
Max. output current during the recovery time	A	1.28	1.8	2.4	3.15
Brake chopper					
Max. output current	A	2.17	2.17	3.9	3.9
Min. brake resistance	Ω	180	180	100	100
Motor cable length					
geschirmt, ohne EMV	m	50			
C1 residential area (2 kHz, 4 kHz, 8 kHz)	m	3			
C2 residential area / industrial premises	m	15		20	
Weight	kg	0.8		1	

# Inverter

Technical data

1-phase mains connection 230 V



Inverter		i550-C1.1/230-1	i550-C1.5/230-1	i550-C2.2/230-1
<b>Rated power</b>	<b>kW</b>	<b>1.1</b>	<b>1.5</b>	<b>2.2</b>
Mains voltage range		1/N/PE AC 170 V ... 264 V, 45 Hz ... 65 Hz		
Rated mains current				
without mains choke	A	14.3	16.7	22.5
with mains choke	A	11.9	13.9	16.9
Output current				
2 kHz	A	6	7	9.6
4 kHz	A	6	7	9.6
8 kHz	A	6	7	9.6
16 kHz	A	4	4.7	6.4
Power loss	W	42	50	70
Overcurrent cycle 180 s				
Max. output current	A	9	10.5	14.4
Overload time	s	60	60	60
Recovery time	s	120	120	120
Max. output current during the recovery time	A	4.5	5.25	7.2
Overcurrent cycle 15 s				
Max. output current	A	12	14	19.2
Overload time	s	3	3	3
Recovery time	s	12	12	12
Max. output current during the recovery time	A	4.5	5.25	7.2
Brake chopper				
Max. output current	A	11.82	11.82	11.82
Min. brake resistance	Ω	33	33	33
Motor cable length				
geschirmt, ohne EMV	m	50		
C1 residential area (2 kHz, 4 kHz, 8 kHz)	m	3		
C2 residential area / industrial premises	m	20		
Weight	kg	1.35		



# Inverter

Technical data  
1-phase mains connection 230 V

## Fusing and terminal data

Inverter		i550-C0.25/230-1	i550-C0.37/230-1	i550-C0.55/230-1	i550-C0.75/230-1
Cable installation in compliance with		EN 60204-1			
Laying system		B2			
Operation		without mains choke			
Fuse					
Fusing characteristics		gG/gL or gRL			
Max. rated fuse current	A	10	10	16	16
Circuit breaker					
Fusing characteristics		B			
Max. rated fuse current	A	10	10	16	16
Operation		with mains choke			
Fuse					
Fusing characteristics		gG/gL or gRL			
Max. rated fuse current	A	10	10	16	16
Circuit breaker					
Fusing characteristics		B			
Max. rated fuse current	A	10	10	16	16
Earth-leakage circuit breaker		≥ 30 mA, type A or B			
Mains connection					
Connection		X100			
Connection type		Screw terminal			
Min. cable cross-section	mm <sup>2</sup>	1			
Max. cable cross-section	mm <sup>2</sup>	2.5			
Stripping length	mm	8			
Tightening torque	Nm	0.5			
Required tool		0.5 x 3.0			
Motor connection					
Connection		X105			
Connection type		Screw terminal			
Min. cable cross-section	mm <sup>2</sup>	1			
Max. cable cross-section	mm <sup>2</sup>	2.5			
Stripping length	mm	8			
Tightening torque	Nm	0.5			
Required tool		0.5 x 3.0			
PE connection					
Connection		PE			
Connection type		PE screw			
Min. cable cross-section	mm <sup>2</sup>	1			
Max. cable cross-section	mm <sup>2</sup>	6			
Stripping length	mm	10			
Tightening torque	Nm	1.2			
Required tool		0.8 x 5.5			

# Inverter

Technical data

1-phase mains connection 230 V



Inverter		i550-C1.1/230-1	i550-C1.5/230-1	i550-C2.2/230-1
Cable installation in compliance with		EN 60204-1		
Laying system		B2		
Operation		without mains choke		
Fuse		gG/gL or gRL		
Fusing characteristics		gG/gL or gRL		
Max. rated fuse current	A	25	25	25
Circuit breaker		B		
Fusing characteristics		B		
Max. rated fuse current	A	25	25	25
Operation		with mains choke		
Fuse		gG/gL or gRL		
Fusing characteristics		gG/gL or gRL		
Max. rated fuse current	A	25	25	25
Circuit breaker		B		
Fusing characteristics		B		
Max. rated fuse current	A	25	25	25
Earth-leakage circuit breaker		≥ 30 mA, type A or B		
Mains connection		X100		
Connection		X100		
Connection type		Screw terminal		
Min. cable cross-section	mm <sup>2</sup>	1		
Max. cable cross-section	mm <sup>2</sup>	6		
Stripping length	mm	8		
Tightening torque	Nm	0.7		
Required tool		0.6 x 3.5		
Motor connection		X105		
Connection		X105		
Connection type		Screw terminal		
Min. cable cross-section	mm <sup>2</sup>	1		
Max. cable cross-section	mm <sup>2</sup>	2.5		
Stripping length	mm	8		
Tightening torque	Nm	0.5		
Required tool		0.5 x 3.0		
PE connection		PE		
Connection		PE		
Connection type		PE screw		
Min. cable cross-section	mm <sup>2</sup>	1		
Max. cable cross-section	mm <sup>2</sup>	6		
Stripping length	mm	10		
Tightening torque	Nm	1.2		
Required tool		0.8 x 5.5		





**1/3-phase mains connection 230/240 V**

**Rated data**

The output currents apply to these operating conditions:

- At a switching frequency of 2 kHz or 4 kHz: Max. ambient temperature 45°C.
- At a switching frequency of 8 kHz or 16 kHz: Max. ambient temperature 40 °C.

Inverter		i550-C0.25/230-2	i550-C0.37/230-2	i550-C0.55/230-2	i550-C0.75/230-2
<b>Rated power</b>	<b>kW</b>	<b>0.25</b>	<b>0.37</b>	<b>0.55</b>	<b>0.75</b>
Mains voltage range		1/N/PE AC 170 V ... 264 V, 45 Hz ... 65 Hz			
Rated mains current					
without mains choke	A	4	5.7	7.6	10
with mains choke	A	3.6	4.8	7.1	8.8
Mains voltage range		3/PE AC 170 V ... 264 V, 45 Hz ... 65 Hz			
Rated mains current					
without mains choke	A	2.6	3.9	4.8	6.4
with mains choke	A	2	3	3.8	5.1
Output current					
2 kHz	A	-	-	3.2	4.2
4 kHz	A	1.7	2.4	3.2	4.2
8 kHz	A	1.7	2.4	3.2	4.2
16 kHz	A	1.1	1.6	2.1	2.8
Power loss	W	17	22	28	36
Overcurrent cycle 180 s					
Max. output current	A	2.55	3.6	4.8	6.3
Overload time	s	60	60	60	60
Recovery time	s	120	120	120	120
Max. output current during the recovery time	A	1.28	1.8	2.4	3.15
Overcurrent cycle 15 s					
Max. output current	A	3.4	4.8	6.4	8.4
Overload time	s	3	3	3	3
Recovery time	s	12	12	12	12
Max. output current during the recovery time	A	1.28	1.8	2.4	3.15
Motor cable length					
geschirmt, ohne EMV	m	50			
Weight	kg	0.8		1	

# Inverter

Technical data

1/3-phase mains connection 230/240 V



Inverter		i550-C1.1/230-2	i550-C1.5/230-2	i550-C2.2/230-2
<b>Rated power</b>	<b>kW</b>	<b>1.1</b>	<b>1.5</b>	<b>2.2</b>
Mains voltage range		1/N/PE AC 170 V ... 264 V, 45 Hz ... 65 Hz		
Rated mains current				
without mains choke	A	14.3	16.7	22.5
with mains choke	A	11.9	13.9	16.9
Mains voltage range		3/PE AC 170 V ... 264 V, 45 Hz ... 65 Hz		
Rated mains current				
without mains choke	A	7.8	9.5	13.6
with mains choke	A	5.6	6.8	9.8
Output current				
2 kHz	A	6	7	9.6
4 kHz	A	6	7	9.6
8 kHz	A	6	7	9.6
16 kHz	A	4	4.7	6.4
Power loss	W	46	55	77
Overcurrent cycle 180 s				
Max. output current	A	9	10.5	14.4
Overload time	s	60	60	60
Recovery time	s	120	120	120
Max. output current during the recovery time	A	4.5	5.25	7.2
Overcurrent cycle 15 s				
Max. output current	A	12	14	19.2
Overload time	s	3	3	3
Recovery time	s	12	12	12
Max. output current during the recovery time	A	4.5	5.25	7.2
Motor cable length				
geschirmt, ohne EMV	m	50		
Weight	kg	1.35		



# Inverter

Technical data  
1/3-phase mains connection 230/240 V

## Fusing and terminal data

Inverter		i550-C0.25/230-2	i550-C0.37/230-2	i550-C0.55/230-2	i550-C0.75/230-2
Cable installation in compliance with		EN 60204-1			
Laying system		B2			
Operation		without mains choke			
Fuse		gG/gL or gRL			
Fusing characteristics		gG/gL or gRL			
Max. rated fuse current	A	10	10	16	16
Circuit breaker		B			
Fusing characteristics		B			
Max. rated fuse current	A	10	10	16	16
Operation		with mains choke			
Fuse		gG/gL or gRL			
Fusing characteristics		gG/gL or gRL			
Max. rated fuse current	A	10	10	16	16
Circuit breaker		B			
Fusing characteristics		B			
Max. rated fuse current	A	10	10	16	16
Earth-leakage circuit breaker		$\geq 30$ mA, type A or B $\geq 30$ mA, type B			
Mains connection		X100			
Connection		X100			
Connection type		Screw terminal			
Min. cable cross-section	mm <sup>2</sup>	1			
Max. cable cross-section	mm <sup>2</sup>	2.5			
Stripping length	mm	8			
Tightening torque	Nm	0.5			
Required tool		0.5 x 3.0			
Motor connection		X105			
Connection		X105			
Connection type		Screw terminal			
Min. cable cross-section	mm <sup>2</sup>	1			
Max. cable cross-section	mm <sup>2</sup>	2.5			
Stripping length	mm	8			
Tightening torque	Nm	0.5			
Required tool		0.5 x 3.0			
PE connection		PE			
Connection		PE			
Connection type		PE screw			
Min. cable cross-section	mm <sup>2</sup>	1			
Max. cable cross-section	mm <sup>2</sup>	6			
Stripping length	mm	10			
Tightening torque	Nm	1.2			
Required tool		0.8 x 5.5			

# Inverter

Technical data

1/3-phase mains connection 230/240 V



Inverter		i550-C1.1/230-2	i550-C1.5/230-2	i550-C2.2/230-2
Cable installation in compliance with		EN 60204-1		
Laying system		B2		
Operation		without mains choke		
Fuse		gG/gL or gRL		
Fusing characteristics		gG/gL or gRL		
Max. rated fuse current	A	25	25	25
Circuit breaker		B		
Fusing characteristics		B		
Max. rated fuse current	A	25	25	25
Operation		with mains choke		
Fuse		gG/gL or gRL		
Fusing characteristics		gG/gL or gRL		
Max. rated fuse current	A	25	25	25
Circuit breaker		B		
Fusing characteristics		B		
Max. rated fuse current	A	25	25	25
Earth-leakage circuit breaker		≥ 30 mA, type A or B ≥ 30 mA, type B		
Mains connection		X100		
Connection		Screw terminal		
Connection type		Screw terminal		
Min. cable cross-section	mm <sup>2</sup>	1		
Max. cable cross-section	mm <sup>2</sup>	6		
Stripping length	mm	8		
Tightening torque	Nm	0.7		
Required tool		0.6 x 3.5		
Motor connection		X105		
Connection		Screw terminal		
Connection type		Screw terminal		
Min. cable cross-section	mm <sup>2</sup>	1		
Max. cable cross-section	mm <sup>2</sup>	2.5		
Stripping length	mm	8		
Tightening torque	Nm	0.5		
Required tool		0.5 x 3.0		
PE connection		PE		
Connection		PE screw		
Connection type		PE screw		
Min. cable cross-section	mm <sup>2</sup>	1		
Max. cable cross-section	mm <sup>2</sup>	6		
Stripping length	mm	10		
Tightening torque	Nm	1.2		
Required tool		0.8 x 5.5		



### 3-phase mains connection 400 V

#### Rated data

The output currents apply to these operating conditions:

- At a switching frequency of 2 kHz or 4 kHz: Max. ambient temperature 45°C.
- At a switching frequency of 8 kHz or 16 kHz: Max. ambient temperature 40 °C.

Inverter		i550-C0.37/400-3	i550-C0.55/400-3	i550-C0.75/400-3	i550-C1.1/400-3
<b>Rated power</b>	<b>kW</b>	<b>0.37</b>	<b>0.55</b>	<b>0.75</b>	<b>1.1</b>
Mains voltage range		3/PE AC 340 V ... 528 V, 45 Hz ... 65 Hz			
Rated mains current					
without mains choke	A	1.8	2.5	3.3	4.4
with mains choke	A	1.4	2	2.6	3
Output current					
2 kHz	A	-	1.8	2.4	3.2
4 kHz	A	1.3	1.8	2.4	3.2
8 kHz	A	1.3	1.8	2.4	3.2
16 kHz	A	0.9	1.2	1.6	2.1
Power loss	W	24	31	40	51
Overcurrent cycle 180 s					
Max. output current	A	1.95	2.7	3.6	4.8
Overload time	s	60	60	60	60
Recovery time	s	120	120	120	120
Max. output current during the recovery time	A	0.975	1.35	1.8	2.4
Overcurrent cycle 15 s					
Max. output current	A	2.6	3.6	4.8	6.4
Overload time	s	3	3	3	3
Recovery time	s	12	12	12	12
Max. output current during the recovery time	A	0.975	1.35	1.8	2.4
Brake chopper					
Max. output current	A	1.86	1.86	1.86	4.03
Min. brake resistance	Ω	390	390	390	180
Motor cable length					
geschirmt, ohne EMV	m	15	50		
C1 residential area (2 kHz, 4 kHz, 8 kHz)	m	3			-
C2 residential area / industrial premises	m	15	20		
Weight	kg	0.8	1		1.35

# Inverter

Technical data

3-phase mains connection 400 V



Inverter		i550-C1.5/400-3	i550-C2.2/400-3	i550-C3.0/400-3	i550-C4.0/400-3
<b>Rated power</b>	<b>kW</b>	<b>1.5</b>	<b>2.2</b>	<b>3</b>	<b>4</b>
Mains voltage range		3/PE AC 340 V ... 528 V, 45 Hz ... 65 Hz			
Rated mains current					
without mains choke	A	5.4	7.8	9.6	12.5
with mains choke	A	3.7	5.3	6.9	9
Output current					
2 kHz	A	3.9	5.6	7.3	9.5
4 kHz	A	3.9	5.6	7.3	9.5
8 kHz	A	3.9	5.6	7.3	9.5
16 kHz	A	2.6	3.7	4.9	6.3
Power loss	W	61	85	109	140
Overcurrent cycle 180 s					
Max. output current	A	5.85	8.4	11	14.3
Overload time	s	60	60	60	60
Recovery time	s	120	120	120	120
Max. output current during the recovery time	A	2.93	4.2	5.48	7.13
Overcurrent cycle 15 s					
Max. output current	A	7.8	11.2	14.6	19
Overload time	s	3	3	3	3
Recovery time	s	12	12	12	12
Max. output current during the recovery time	A	2.93	4.2	5.48	7.13
Brake chopper					
Max. output current	A	4.03	4.83	8.84	15.43
Min. brake resistance	Ω	180	150	82	47
Motor cable length					
geschirmt, ohne EMV	m	50			
C1 residential area (2 kHz, 4 kHz, 8 kHz)	m	-			
C2 residential area / industrial premises	m	20			
Weight	kg	1.35		2.3	



# Inverter

Technical data  
3-phase mains connection 400 V

Inverter		i550-C5.5/400-3	i550-C7.5/400-3	i550-C11/400-3	i550-C15/400-3
<b>Rated power</b>	<b>kW</b>	<b>5.5</b>	<b>7.5</b>	<b>11</b>	<b>15</b>
Mains voltage range		3/PE AC 340 V ... 528 V, 45 Hz ... 65 Hz			
Rated mains current					
without mains choke	A	17.2	20	28.4	38.7
with mains choke	A	12.4	15.7	22.3	28.8
Output current					
2 kHz	A	13	16.5	23.5	32
4 kHz	A	13	16.5	23.5	32
8 kHz	A	13	16.5	23.5	32
16 kHz	A	8.7	11	15.7	21.3
Power loss	W	189	238	337	457
Overcurrent cycle 180 s					
Max. output current	A	19.5	24.8	35.3	48
Overload time	s	60	60	60	60
Recovery time	s	120	120	120	120
Max. output current during the recovery time	A	9.75	12.4	17.6	24
Overcurrent cycle 15 s					
Max. output current	A	26	33	47	64
Overload time	s	3	3	3	3
Recovery time	s	12	12	12	12
Max. output current during the recovery time	A	9.75	12.4	17.6	24
Brake chopper					
Max. output current	A	15.43	26.85	26.85	40.28
Min. brake resistance	Ω	47	27	27	18
Motor cable length					
geschirmt, ohne EMV	m	50	100		
C1 residential area (2 kHz, 4 kHz, 8 kHz)	m	-			
C2 residential area / industrial premises	m	20			
Weight	kg	2.3	3.7		10.3

# Inverter

Technical data

3-phase mains connection 400 V



Inverter		i550-C18/400-3	i550-C22/400-3	i550-C30/400-3	i550-C37/400-3
<b>Rated power</b>	<b>kW</b>	<b>18.5</b>	<b>22</b>	<b>30</b>	<b>37</b>
Mains voltage range		3/PE AC 340 V ... 528 V, 45 Hz ... 65 Hz			
Rated mains current					
without mains choke	A	48.4	-	-	-
with mains choke	A	36	42.3	54.9	68.4
Output current					
2 kHz	A	40	47	61	76
4 kHz	A	40	47	61	76
8 kHz	A	40	47	61	76
16 kHz	A	26.6	31.3	40.7	50.7
Power loss	W	569	668	885	1095
Overcurrent cycle 180 s					
Max. output current	A	60	70.5	91.5	114
Overload time	s	60	60	60	60
Recovery time	s	120	120	120	120
Max. output current during the recovery time	A	30	35.3	45.8	57
Overcurrent cycle 15 s					
Max. output current	A	80	94	122	152
Overload time	s	3	3	3	3
Recovery time	s	12	12	12	12
Max. output current during the recovery time	A	30	35.3	45.8	57
Brake chopper					
Max. output current	A	48.33	48.33	90.6	90.6
Min. brake resistance	Ω	15	15	8	8
Motor cable length					
geschirmt, ohne EMV	m	100			
C1 residential area (2 kHz, 4 kHz, 8 kHz)	m	-			
C2 residential area / industrial premises	m	20			
Weight	kg	10.3		17.2	





# Inverter

Technical data  
3-phase mains connection 400 V

Inverter		i550-C45/400-3
<b>Rated power</b>	<b>kW</b>	<b>45</b>
Mains voltage range		3/PE AC 340 V ... 528 V, 45 Hz ... 65 Hz
Rated mains current		
without mains choke	A	-
with mains choke	A	80.1
Output current		
2 kHz	A	89
4 kHz	A	89
8 kHz	A	89
16 kHz	A	59.4
Power loss	W	1280
Overcurrent cycle 180 s		
Max. output current	A	134
Overload time	s	60
Recovery time	s	120
Max. output current during the recovery time	A	66.8
Overcurrent cycle 15 s		
Max. output current	A	178
Overload time	s	3
Recovery time	s	12
Max. output current during the recovery time	A	66.8
Brake chopper		
Max. output current	A	90.6
Min. brake resistance	Ω	8
Motor cable length		
geschirmt, ohne EMV	m	100
C1 residential area (2 kHz, 4 kHz, 8 kHz)	m	-
C2 residential area / industrial premises	m	20
Weight	kg	17.2

# Inverter

Technical data  
3-phase mains connection 400 V



## Fusing and terminal data

Inverter		i550-C0.37/400-3	i550-C0.55/400-3	i550-C0.75/400-3	i550-C1.1/400-3
Cable installation in compliance with		EN 60204-1			
Laying system		B2			
Operation		without mains choke			
Fuse		gG/gL or gRL			
Fusing characteristics		gG/gL or gRL			
Max. rated fuse current	A	10	10	10	16
Circuit breaker		B			
Fusing characteristics		B			
Max. rated fuse current	A	10	10	10	16
Operation		with mains choke			
Fuse		gG/gL or gRL			
Fusing characteristics		gG/gL or gRL			
Max. rated fuse current	A	10	10	10	16
Circuit breaker		B			
Fusing characteristics		B			
Max. rated fuse current	A	10	10	10	16
Earth-leakage circuit breaker		≥ 30 mA, type B			
Mains connection		X100			
Connection		X100			
Connection type		Screw terminal			
Min. cable cross-section	mm <sup>2</sup>	1			
Max. cable cross-section	mm <sup>2</sup>	2.5			
Stripping length	mm	8			
Tightening torque	Nm	0.5			
Required tool		0.5 x 3.0			
Motor connection		X105			
Connection		X105			
Connection type		Screw terminal			
Min. cable cross-section	mm <sup>2</sup>	1			
Max. cable cross-section	mm <sup>2</sup>	2.5			
Stripping length	mm	8			
Tightening torque	Nm	0.5			
Required tool		0.5 x 3.0			
PE connection		PE			
Connection		PE			
Connection type		PE screw			
Min. cable cross-section	mm <sup>2</sup>	1			
Max. cable cross-section	mm <sup>2</sup>	6			
Stripping length	mm	10			
Tightening torque	Nm	1.2			
Required tool		0.8 x 5.5			



# Inverter

Technical data  
3-phase mains connection 400 V

Inverter		i550-C1.5/400-3	i550-C2.2/400-3	i550-C3.0/400-3	i550-C4.0/400-3
Cable installation in compliance with		EN 60204-1			
Laying system		B2			
Operation		without mains choke			
Fuse		gG/gL or gRL			
Fusing characteristics		gG/gL or gRL			
Max. rated fuse current	A	16	16	25	25
Circuit breaker		B			
Fusing characteristics		B			
Max. rated fuse current	A	16	16	25	25
Operation		with mains choke			
Fuse		gG/gL or gRL			
Fusing characteristics		gG/gL or gRL			
Max. rated fuse current	A	16	16	25	25
Circuit breaker		B			
Fusing characteristics		B			
Max. rated fuse current	A	16	16	25	25
Earth-leakage circuit breaker		≥ 30 mA, type B		≥ 300 mA, type B	
Mains connection		X100			
Connection		X100			
Connection type		Screw terminal			
Min. cable cross-section	mm <sup>2</sup>	1		1.5	
Max. cable cross-section	mm <sup>2</sup>	2.5		6	
Stripping length	mm	8		9	
Tightening torque	Nm	0.5			
Required tool		0.5 x 3.0		0.6 x 3.5	
Motor connection		X105			
Connection		X105			
Connection type		Screw terminal			
Min. cable cross-section	mm <sup>2</sup>	1		1.5	
Max. cable cross-section	mm <sup>2</sup>	2.5		6	
Stripping length	mm	8		9	
Tightening torque	Nm	0.5			
Required tool		0.5 x 3.0		0.6 x 3.5	
PE connection		PE			
Connection		PE			
Connection type		PE screw			
Min. cable cross-section	mm <sup>2</sup>	1		1.5	
Max. cable cross-section	mm <sup>2</sup>	6			
Stripping length	mm	10			
Tightening torque	Nm	1.2			
Required tool		0.8 x 5.5			

# Inverter

Technical data

3-phase mains connection 400 V



Inverter		i550-C5.5/400-3	i550-C7.5/400-3	i550-C11/400-3	i550-C15/400-3
Cable installation in compliance with		EN 60204-1			
Laying system		B2			
Operation		without mains choke			
Fuse					
Fusing characteristics		gG/gL or gRL			
Max. rated fuse current	A	25	32	32	63
Circuit breaker					
Fusing characteristics		B			
Max. rated fuse current	A	25	32	32	63
Operation		with mains choke			
Fuse					
Fusing characteristics		gG/gL or gRL			
Max. rated fuse current	A	25	32	32	63
Circuit breaker					
Fusing characteristics		B			
Max. rated fuse current	A	25	32	32	63
Earth-leakage circuit breaker		≥ 300 mA, type B			
Mains connection					
Connection		X100			
Connection type		Screw terminal			
Min. cable cross-section	mm <sup>2</sup>	1.5			
Max. cable cross-section	mm <sup>2</sup>	6	16	35	
Stripping length	mm	9	11	18	
Tightening torque	Nm	0.5	1.2	3.8	
Required tool		0.6 x 3.5	0.8 x 4.0	0.8 x 5.5	
Motor connection					
Connection		X105			
Connection type		Screw terminal			
Min. cable cross-section	mm <sup>2</sup>	1.5			
Max. cable cross-section	mm <sup>2</sup>	6	16	35	
Stripping length	mm	9	11	18	
Tightening torque	Nm	0.5	1.2	3.8	
Required tool		0.6 x 3.5	0.8 x 4.0	0.8 x 5.5	
PE connection					
Connection		PE			
Connection type		PE screw			
Min. cable cross-section	mm <sup>2</sup>	1.5			
Max. cable cross-section	mm <sup>2</sup>	6	16	25	
Stripping length	mm	10	11	16	
Tightening torque	Nm	1.2	3.4	4	
Required tool		0.8 x 5.5	P22		



# Inverter

Technical data  
3-phase mains connection 400 V

Inverter		i550-C18/400-3	i550-C22/400-3	i550-C30/400-3	i550-C37/400-3
Cable installation in compliance with		EN 60204-1			
Laying system		B2		C	
Operation		without mains choke	-		
Fuse		-			
Fusing characteristics		gG/gL or gRL		-	
Max. rated fuse current	A	63		-	
Circuit breaker		-			
Fusing characteristics		B		-	
Max. rated fuse current	A	63		-	
Operation		with mains choke			
Fuse		-			
Fusing characteristics		gG/gL or gRL			
Max. rated fuse current	A	63	63	80	100
Circuit breaker		-			
Fusing characteristics		B			
Max. rated fuse current	A	63	63	80	100
Earth-leakage circuit breaker		≥ 300 mA, type B			
Mains connection		-			
Connection		X100			
Connection type		Screw terminal			
Min. cable cross-section	mm <sup>2</sup>	1.5		10	
Max. cable cross-section	mm <sup>2</sup>	35		50	
Stripping length	mm	18		19	
Tightening torque	Nm	3.8		4	
Required tool		0.8 x 5.5		Allen key 4.0	
Motor connection		-			
Connection		X105			
Connection type		Screw terminal			
Min. cable cross-section	mm <sup>2</sup>	1.5		10	
Max. cable cross-section	mm <sup>2</sup>	35		50	
Stripping length	mm	18		19	
Tightening torque	Nm	3.8		4	
Required tool		0.8 x 5.5			
PE connection		-			
Connection		PE			
Connection type		PE screw			
Min. cable cross-section	mm <sup>2</sup>	1.5			
Max. cable cross-section	mm <sup>2</sup>	25			
Stripping length	mm	16			
Tightening torque	Nm	4			
Required tool		PZ2			

# Inverter

Technical data

3-phase mains connection 400 V



Inverter		i550-C45/400-3
Cable installation in compliance with		EN 60204-1
Laying system		C
Operation		-
Fuse		-
Fusing characteristics		-
Max. rated fuse current	A	-
Circuit breaker		-
Fusing characteristics		-
Max. rated fuse current	A	-
Operation		with mains choke
Fuse		
Fusing characteristics		gG/gL or gRL
Max. rated fuse current	A	125
Circuit breaker		
Fusing characteristics		B
Max. rated fuse current	A	125
Earth-leakage circuit breaker		≥ 300 mA, type B
Mains connection		
Connection		X100
Connection type		Screw terminal
Min. cable cross-section	mm <sup>2</sup>	10
Max. cable cross-section	mm <sup>2</sup>	50
Stripping length	mm	19
Tightening torque	Nm	4
Required tool		Allen key 4.0
Motor connection		
Connection		X105
Connection type		Screw terminal
Min. cable cross-section	mm <sup>2</sup>	10
Max. cable cross-section	mm <sup>2</sup>	50
Stripping length	mm	19
Tightening torque	Nm	4
Required tool		0.8 x 5.5
PE connection		
Connection		PE
Connection type		PE screw
Min. cable cross-section	mm <sup>2</sup>	1.5
Max. cable cross-section	mm <sup>2</sup>	25
Stripping length	mm	16
Tightening torque	Nm	4
Required tool		PZ2



### 3-phase mains connection 480 V

#### Rated data

The output currents apply to these operating conditions:

- At a switching frequency of 2 kHz or 4 kHz: Max. ambient temperature 45°C.
- At a switching frequency of 8 kHz or 16 kHz: Max. ambient temperature 40 °C.

Inverter		i550-C0.37/400-3	i550-C0.55/400-3	i550-C0.75/400-3	i550-C1.1/400-3
<b>Rated power</b>	<b>kW</b>	<b>0.37</b>	<b>0.55</b>	<b>0.75</b>	<b>1.1</b>
Mains voltage range		3/PE AC 340 V ... 528 V, 45 Hz ... 65 Hz			
Rated mains current					
without mains choke	A	1.5	2.1	2.8	3.7
with mains choke	A	1.2	1.7	2.2	2.5
Output current					
2 kHz	A	-	1.6	2.1	3
4 kHz	A	1.1	1.6	2.1	3
8 kHz	A	1.1	1.6	2.1	3
16 kHz	A	0.7	1.1	1.4	2
Power loss	W	24	31	40	51
Overcurrent cycle 180 s					
Max. output current	A	1.65	2.4	3.15	4.5
Overload time	s	60	60	60	60
Recovery time	s	120	120	120	120
Max. output current during the recovery time	A	0.825	1.2	1.58	2.25
Overcurrent cycle 15 s					
Max. output current	A	2.2	3.2	4.2	6
Overload time	s	3	3	3	3
Recovery time	s	12	12	12	12
Max. output current during the recovery time	A	0.825	1.2	1.58	2.25
Brake chopper					
Max. output current	A	2	2	2	4.33
Min. brake resistance	Ω	390	390	390	180
Motor cable length					
geschirmt, ohne EMV	m	15	50		
C1 residential area (2 kHz, 4 kHz, 8 kHz)	m	3			-
C2 residential area / industrial premises	m	15	20		
Weight	kg	0.8	1		1.35

# Inverter

Technical data

3-phase mains connection 480 V



Inverter		i550-C1.5/400-3	i550-C2.2/400-3	i550-C3.0/400-3	i550-C4.0/400-3
<b>Rated power</b>	<b>kW</b>	<b>1.5</b>	<b>2.2</b>	<b>3</b>	<b>4</b>
Mains voltage range		3/PE AC 340 V ... 528 V, 45 Hz ... 65 Hz			
Rated mains current					
without mains choke	A	4.5	6.5	8	10.5
with mains choke	A	3.1	4.4	5.8	7.5
Output current					
2 kHz	A	3.5	4.8	6.3	8.2
4 kHz	A	3.5	4.8	6.3	8.2
8 kHz	A	3.5	4.8	6.3	8.2
16 kHz	A	2.3	3.2	4.2	5.5
Power loss	W	61	85	109	140
Overcurrent cycle 180 s					
Max. output current	A	5.25	7.2	9.45	12.3
Overload time	s	60	60	60	60
Recovery time	s	120	120	120	120
Max. output current during the recovery time	A	2.63	3.6	4.73	6.15
Overcurrent cycle 15 s					
Max. output current	A	7	9.6	12.6	16.4
Overload time	s	3	3	3	3
Recovery time	s	12	12	12	12
Max. output current during the recovery time	A	2.63	3.6	4.73	6.15
Brake chopper					
Max. output current	A	4.33	5.2	9.51	16.6
Min. brake resistance	Ω	180	150	82	47
Motor cable length					
geschirmt, ohne EMV	m	50			
C1 residential area (2 kHz, 4 kHz, 8 kHz)	m	-			
C2 residential area / industrial premises	m	20			
Weight	kg	1.35		2.3	





# Inverter

Technical data  
3-phase mains connection 480 V

Inverter		i550-C5.5/400-3	i550-C7.5/400-3	i550-C11/400-3	i550-C15/400-3
<b>Rated power</b>	<b>kW</b>	<b>5.5</b>	<b>7.5</b>	<b>11</b>	<b>15</b>
Mains voltage range		3/PE AC 340 V ... 528 V, 45 Hz ... 65 Hz			
Rated mains current					
without mains choke	A	14.3	16.6	23.7	32.3
with mains choke	A	10.3	13.1	18.6	24
Output current					
2 kHz	A	11	14	21	27
4 kHz	A	11	14	21	27
8 kHz	A	11	14	21	27
16 kHz	A	7.3	9.3	14	18
Power loss	W	189	238	337	457
Overcurrent cycle 180 s					
Max. output current	A	16.5	21	31.5	40.5
Overload time	s	60	60	60	60
Recovery time	s	120	120	120	120
Max. output current during the recovery time	A	8.25	10.5	15.8	20.3
Overcurrent cycle 15 s					
Max. output current	A	22	28	42	54
Overload time	s	3	3	3	3
Recovery time	s	12	12	12	12
Max. output current during the recovery time	A	8.25	10.5	15.8	20.3
Brake chopper					
Max. output current	A	16.6	28.89	28.89	43.33
Min. brake resistance	Ω	47	27	27	18
Motor cable length					
geschirmt, ohne EMV	m	50	100		
C1 residential area (2 kHz, 4 kHz, 8 kHz)	m	-			
C2 residential area / industrial premises	m	20			
Weight	kg	2.3	3.7		10.3

# Inverter

Technical data

3-phase mains connection 480 V



Inverter		i550-C18/400-3	i550-C22/400-3	i550-C30/400-3	i550-C37/400-3
<b>Rated power</b>	<b>kW</b>	<b>18.5</b>	<b>22</b>	<b>30</b>	<b>37</b>
Mains voltage range		3/PE AC 340 V ... 528 V, 45 Hz ... 65 Hz			
Rated mains current					
without mains choke	A	40.3	47.4	-	-
with mains choke	A	30	35.3	45.7	57
Output current					
2 kHz	A	34	40.4	52	65
4 kHz	A	34	40.4	52	65
8 kHz	A	34	40.4	52	65
16 kHz	A	22.6	26.9	34.7	43.4
Power loss	W	569	668	885	1095
Overcurrent cycle 180 s					
Max. output current	A	51	60.6	78	97.5
Overload time	s	60	60	60	60
Recovery time	s	120	120	120	120
Max. output current during the recovery time	A	25.5	30.3	39	48.8
Overcurrent cycle 15 s					
Max. output current	A	68	80.8	104	130
Overload time	s	3	3	3	3
Recovery time	s	12	12	12	12
Max. output current during the recovery time	A	25.5	30.3	39	48.8
Brake chopper					
Max. output current	A	52	52	97.5	97.5
Min. brake resistance	Ω	15	15	8	8
Motor cable length					
geschirmt, ohne EMV	m	100			
C1 residential area (2 kHz, 4 kHz, 8 kHz)	m	-			
C2 residential area / industrial premises	m	20			
Weight	kg	10.3		17.2	



# Inverter

Technical data  
3-phase mains connection 480 V

Inverter		i550-C45/400-3
<b>Rated power</b>	<b>kW</b>	<b>45</b>
Mains voltage range		3/PE AC 340 V ... 528 V, 45 Hz ... 65 Hz
Rated mains current		
without mains choke	A	-
with mains choke	A	66.7
Output current		
2 kHz	A	77
4 kHz	A	77
8 kHz	A	77
16 kHz	A	51.4
Power loss	W	1280
Overcurrent cycle 180 s		
Max. output current	A	116
Overload time	s	60
Recovery time	s	120
Max. output current during the recovery time	A	57.8
Overcurrent cycle 15 s		
Max. output current	A	154
Overload time	s	3
Recovery time	s	12
Max. output current during the recovery time	A	57.8
Brake chopper		
Max. output current	A	97.5
Min. brake resistance	Ω	8
Motor cable length		
geschirmt, ohne EMV	m	100
C1 residential area (2 kHz, 4 kHz, 8 kHz)	m	-
C2 residential area / industrial premises	m	20
Weight	kg	17.2

# Inverter

Technical data  
3-phase mains connection 480 V



## Fusing and terminal data

Inverter		i550-C0.37/400-3	i550-C0.55/400-3	i550-C0.75/400-3	i550-C1.1/400-3
Cable installation in compliance with		EN 60204-1			
Laying system		B2			
Operation		without mains choke			
Fuse		gG/gL or gRL			
Fusing characteristics		gG/gL or gRL			
Max. rated fuse current	A	10	10	10	16
Circuit breaker		B			
Fusing characteristics		B			
Max. rated fuse current	A	10	10	10	16
Operation		with mains choke			
Fuse		gG/gL or gRL			
Fusing characteristics		gG/gL or gRL			
Max. rated fuse current	A	10	10	10	16
Circuit breaker		B			
Fusing characteristics		B			
Max. rated fuse current	A	10	10	10	16
Earth-leakage circuit breaker		≥ 30 mA, type B			
Mains connection		X100			
Connection		X100			
Connection type		Screw terminal			
Min. cable cross-section	mm <sup>2</sup>	1			
Max. cable cross-section	mm <sup>2</sup>	2.5			
Stripping length	mm	8			
Tightening torque	Nm	0.5			
Required tool		0.5 x 3.0			
Motor connection		X105			
Connection		X105			
Connection type		Screw terminal			
Min. cable cross-section	mm <sup>2</sup>	1			
Max. cable cross-section	mm <sup>2</sup>	2.5			
Stripping length	mm	8			
Tightening torque	Nm	0.5			
Required tool		0.5 x 3.0			
PE connection		PE			
Connection		PE			
Connection type		PE screw			
Min. cable cross-section	mm <sup>2</sup>	1			
Max. cable cross-section	mm <sup>2</sup>	6			
Stripping length	mm	10			
Tightening torque	Nm	1.2			
Required tool		0.8 x 5.5			



# Inverter

Technical data  
3-phase mains connection 480 V

Inverter		i550-C1.5/400-3	i550-C2.2/400-3	i550-C3.0/400-3	i550-C4.0/400-3
Cable installation in compliance with		EN 60204-1			
Laying system		B2			
Operation		without mains choke			
Fuse		gG/gL or gRL			
Fusing characteristics		gG/gL or gRL			
Max. rated fuse current	A	16	16	25	25
Circuit breaker		B			
Fusing characteristics		B			
Max. rated fuse current	A	16	16	25	25
Operation		with mains choke			
Fuse		gG/gL or gRL			
Fusing characteristics		gG/gL or gRL			
Max. rated fuse current	A	16	16	25	25
Circuit breaker		B			
Fusing characteristics		B			
Max. rated fuse current	A	16	16	25	25
Earth-leakage circuit breaker		≥ 30 mA, type B		≥ 300 mA, type B	
Mains connection		X100			
Connection		X100			
Connection type		Screw terminal			
Min. cable cross-section	mm <sup>2</sup>	1		1.5	
Max. cable cross-section	mm <sup>2</sup>	2.5		6	
Stripping length	mm	8		9	
Tightening torque	Nm	0.5			
Required tool		0.5 x 3.0		0.6 x 3.5	
Motor connection		X105			
Connection		X105			
Connection type		Screw terminal			
Min. cable cross-section	mm <sup>2</sup>	1		1.5	
Max. cable cross-section	mm <sup>2</sup>	2.5		6	
Stripping length	mm	8		9	
Tightening torque	Nm	0.5			
Required tool		0.5 x 3.0		0.6 x 3.5	
PE connection		PE			
Connection		PE			
Connection type		PE screw			
Min. cable cross-section	mm <sup>2</sup>	1		1.5	
Max. cable cross-section	mm <sup>2</sup>	6			
Stripping length	mm	10			
Tightening torque	Nm	1.2			
Required tool		0.8 x 5.5			

# Inverter

Technical data

3-phase mains connection 480 V



Inverter		i550-C5.5/400-3	i550-C7.5/400-3	i550-C11/400-3	i550-C15/400-3
Cable installation in compliance with		EN 60204-1			
Laying system		B2			
Operation		without mains choke			
Fuse					
Fusing characteristics		gG/gL or gRL			
Max. rated fuse current	A	25	32	32	63
Circuit breaker					
Fusing characteristics		B			
Max. rated fuse current	A	25	32	32	63
Operation		with mains choke			
Fuse					
Fusing characteristics		gG/gL or gRL			
Max. rated fuse current	A	25	32	32	63
Circuit breaker					
Fusing characteristics		B			
Max. rated fuse current	A	25	32	32	63
Earth-leakage circuit breaker		≥ 300 mA, type B			
Mains connection					
Connection		X100			
Connection type		Screw terminal			
Min. cable cross-section	mm <sup>2</sup>	1.5			
Max. cable cross-section	mm <sup>2</sup>	6	16	35	
Stripping length	mm	9	11	18	
Tightening torque	Nm	0.5	1.2	3.8	
Required tool		0.6 x 3.5	0.8 x 4.0	0.8 x 5.5	
Motor connection					
Connection		X105			
Connection type		Screw terminal			
Min. cable cross-section	mm <sup>2</sup>	1.5			
Max. cable cross-section	mm <sup>2</sup>	6	16	35	
Stripping length	mm	9	11	18	
Tightening torque	Nm	0.5	1.2	3.8	
Required tool		0.6 x 3.5	0.8 x 4.0	0.8 x 5.5	
PE connection					
Connection		PE			
Connection type		PE screw			
Min. cable cross-section	mm <sup>2</sup>	1.5			
Max. cable cross-section	mm <sup>2</sup>	6	16	25	
Stripping length	mm	10	11	16	
Tightening torque	Nm	1.2	3.4	4	
Required tool		0.8 x 5.5	P22		



# Inverter

Technical data  
3-phase mains connection 480 V

Inverter		i550-C18/400-3	i550-C22/400-3	i550-C30/400-3	i550-C37/400-3
Cable installation in compliance with		EN 60204-1			
Laying system		B2		C	
Operation		without mains choke			-
Fuse		-			
Fusing characteristics		gG/gL or gRL			-
Max. rated fuse current	A	63			-
Circuit breaker		-			
Fusing characteristics		B			-
Max. rated fuse current	A	63			-
Operation		with mains choke			
Fuse		-			
Fusing characteristics		gG/gL or gRL			
Max. rated fuse current	A	63	63	80	100
Circuit breaker		-			
Fusing characteristics		B			
Max. rated fuse current	A	63	63	80	100
Earth-leakage circuit breaker		≥ 300 mA, type B			
Mains connection		-			
Connection		X100			
Connection type		Screw terminal			
Min. cable cross-section	mm <sup>2</sup>	1.5		10	
Max. cable cross-section	mm <sup>2</sup>	35		50	
Stripping length	mm	18		19	
Tightening torque	Nm	3.8		4	
Required tool		0.8 x 5.5		Allen key 4.0	
Motor connection		-			
Connection		X105			
Connection type		Screw terminal			
Min. cable cross-section	mm <sup>2</sup>	1.5		10	
Max. cable cross-section	mm <sup>2</sup>	35		50	
Stripping length	mm	18		19	
Tightening torque	Nm	3.8		4	
Required tool		0.8 x 5.5			
PE connection		-			
Connection		PE			
Connection type		PE screw			
Min. cable cross-section	mm <sup>2</sup>	1.5			
Max. cable cross-section	mm <sup>2</sup>	25			
Stripping length	mm	16			
Tightening torque	Nm	4			
Required tool		PZ2			

# Inverter

Technical data

3-phase mains connection 480 V



Inverter		i550-C45/400-3
Cable installation in compliance with		EN 60204-1
Laying system		C
Operation		-
Fuse		-
Fusing characteristics		-
Max. rated fuse current	A	-
Circuit breaker		-
Fusing characteristics		-
Max. rated fuse current	A	-
Operation		with mains choke
Fuse		
Fusing characteristics		gG/gL or gRL
Max. rated fuse current	A	125
Circuit breaker		
Fusing characteristics		B
Max. rated fuse current	A	125
Earth-leakage circuit breaker		≥ 300 mA, type B
Mains connection		
Connection		X100
Connection type		Screw terminal
Min. cable cross-section	mm <sup>2</sup>	10
Max. cable cross-section	mm <sup>2</sup>	50
Stripping length	mm	19
Tightening torque	Nm	4
Required tool		Allen key 4.0
Motor connection		
Connection		X105
Connection type		Screw terminal
Min. cable cross-section	mm <sup>2</sup>	10
Max. cable cross-section	mm <sup>2</sup>	50
Stripping length	mm	19
Tightening torque	Nm	4
Required tool		0.8 x 5.5
PE connection		
Connection		PE
Connection type		PE screw
Min. cable cross-section	mm <sup>2</sup>	1.5
Max. cable cross-section	mm <sup>2</sup>	25
Stripping length	mm	16
Tightening torque	Nm	4
Required tool		PZ2





**Dimensions**

**0.25 kW ... 0.37 kW**

The dimensions in mm apply to:

0.25 kW	0.37 kW
i550-C0.25/230-1	i550-C0.37/230-1
i550-C0.25/230-2	i550-C0.37/230-2
	i550-C0.37/400-3

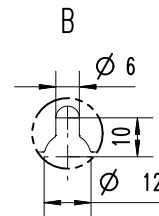
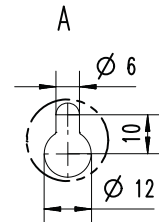
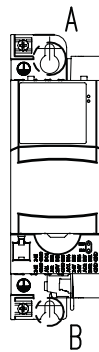
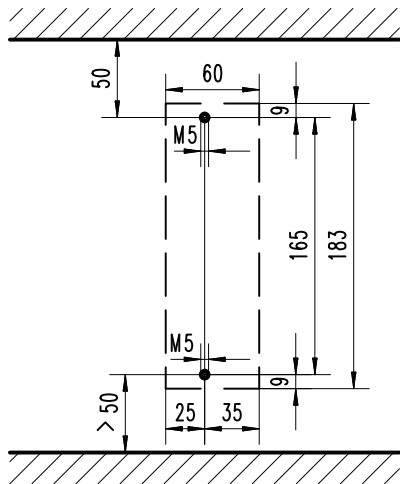
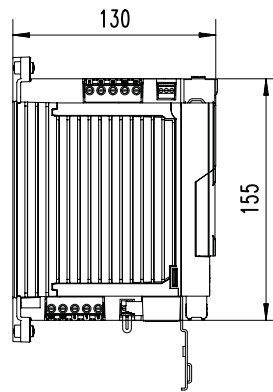
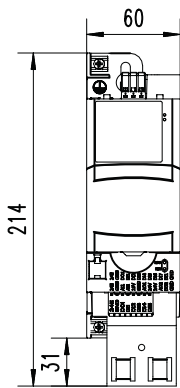

8800263

# Inverter

Technical data  
Dimensions



## 0.55 kW ... 0.75 kW

The dimensions in mm apply to:

0.55 kW

i550-C0.55/230-1

i550-C0.55/230-2

i550-C0.55/400-3

0.75 kW

i550-C0.75/230-1

i550-C0.75/230-2

i550-C0.75/400-3

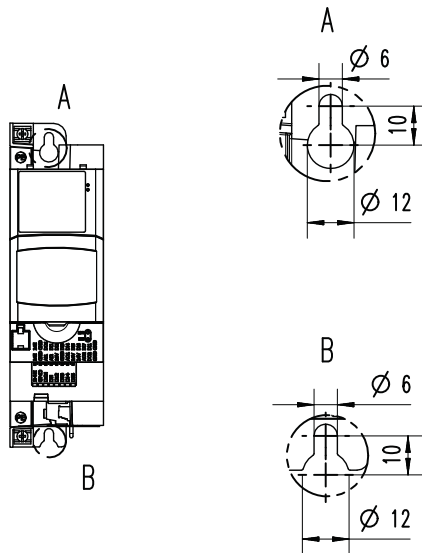
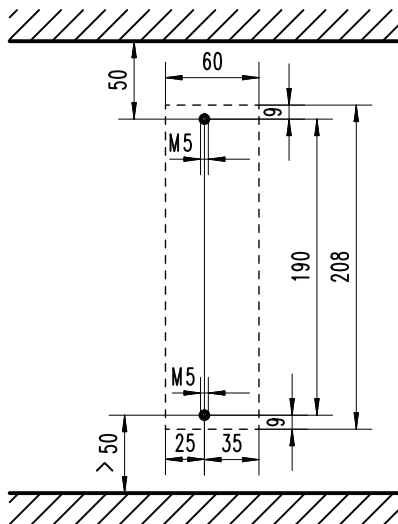
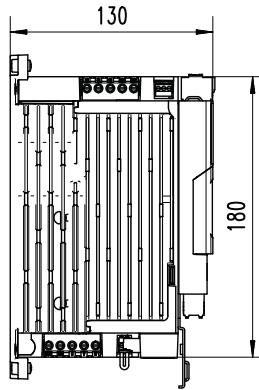
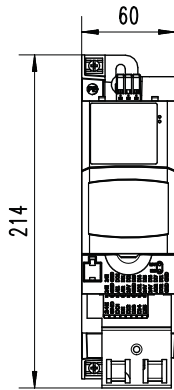

8800264



**1.1 kW ... 2.2 kW**

The dimensions in mm apply to:

1.1 kW

i550-C1.1/230-1

i550-C1.1/230-2

i550-C1.1/400-3

1.5 kW

i550-C1.5/230-1

i550-C1.5/230-2

i550-C1.5/400-3

2.2 kW

i550-C2.2/230-1

i550-C2.2/230-2

i550-C2.2/400-3

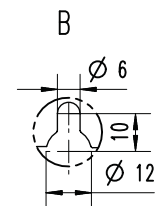
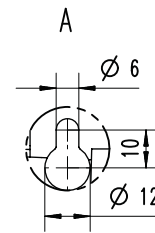
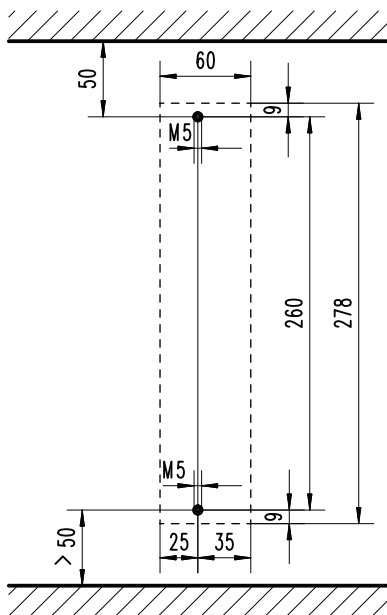
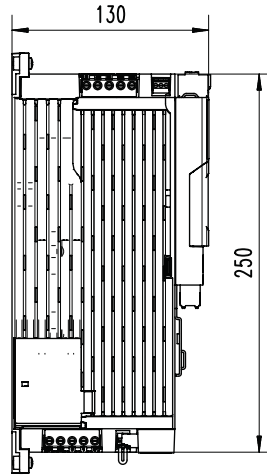
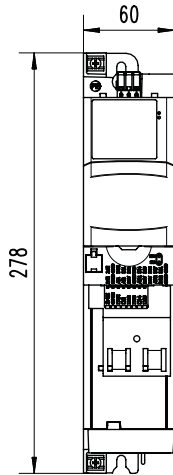

8800265

# Inverter

Technical data  
Dimensions



## 3 kW ... 5.5 kW

The dimensions in mm apply to:

3 kW  
i550-C3/400-3

4 kW  
i550-C4/400-3

5.5 kW  
i550-C5.5/400-3

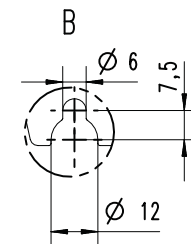
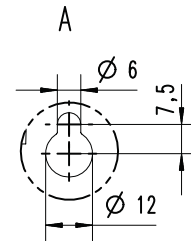
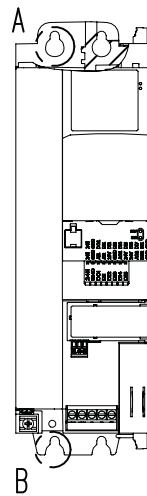
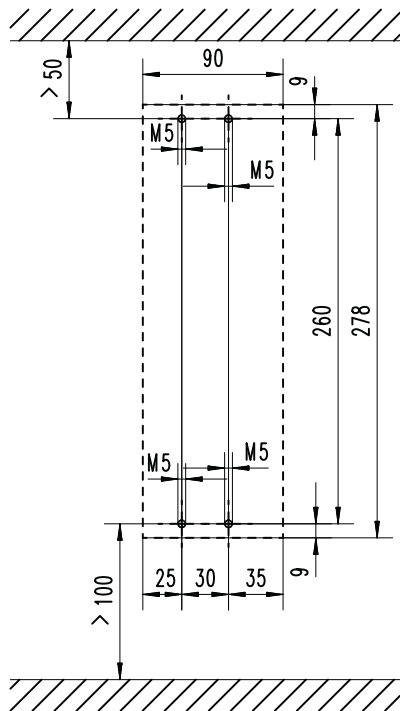
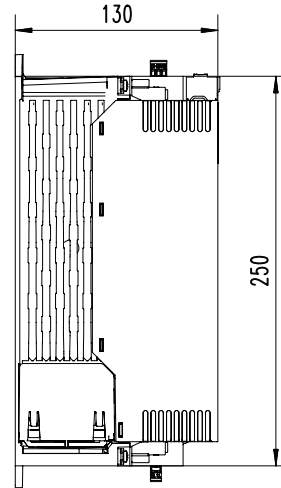
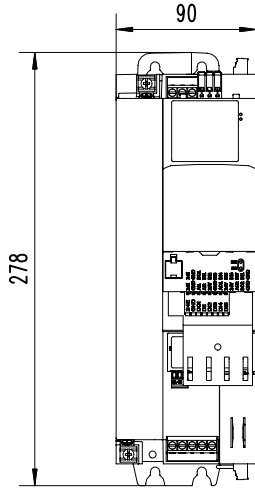

8800288



**7.5 kW ... 11 kW**

The dimensions in mm apply to:

7.5 kW  
 i550-C7.5/400-3

11 kW  
 i550-C11/400-3

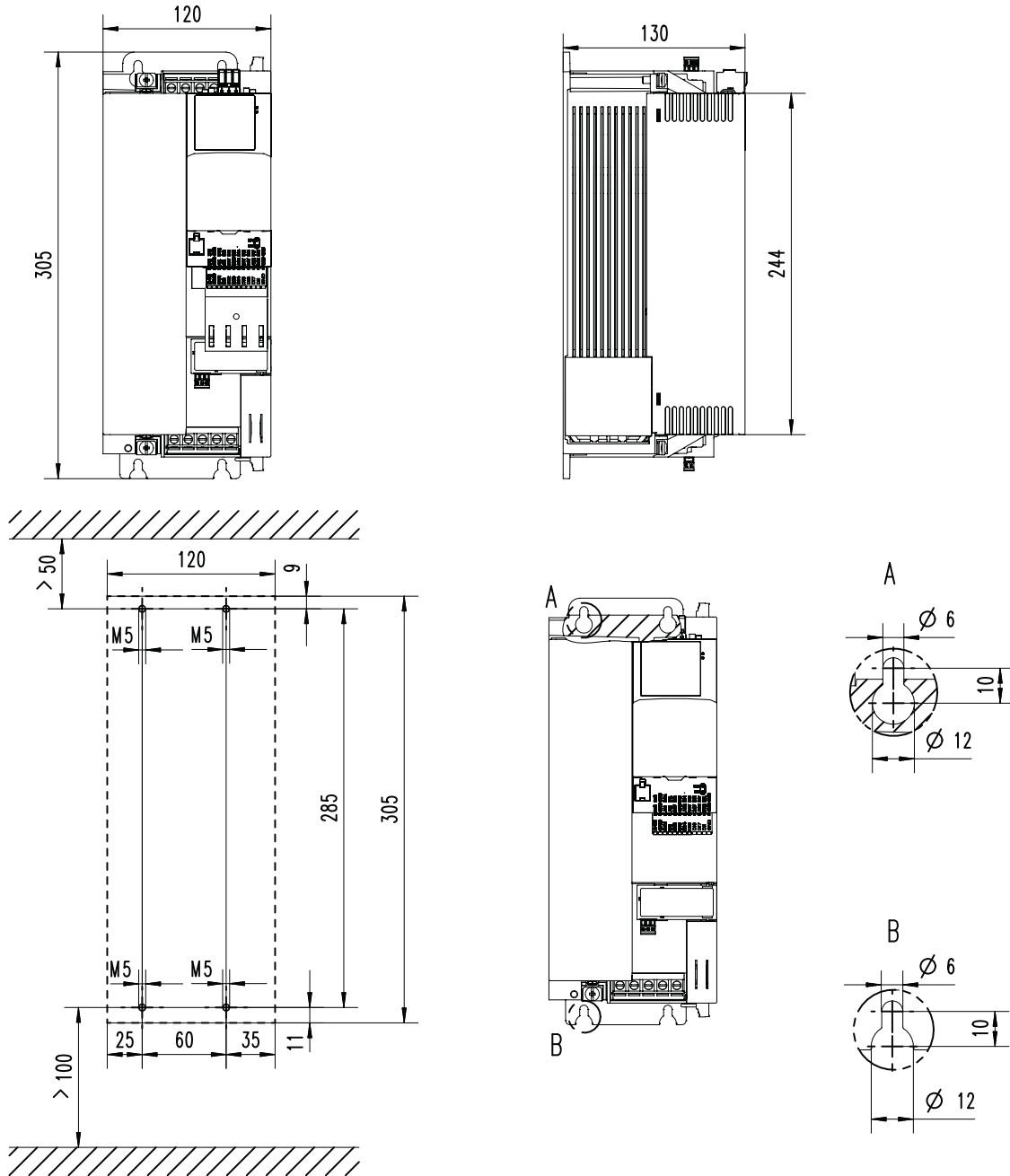

8800296

# Inverter

Technical data  
Dimensions



## 15 kW ... 22 kW

The dimensions in mm apply to:

15 kW  
i550-C15/400-3

18.5 kW  
i550-C18.5/400-3

22 kW  
i550-C22/400-3

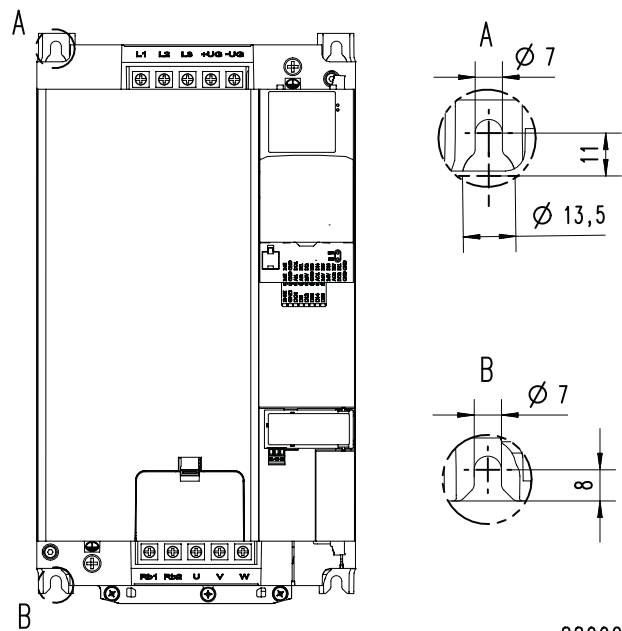
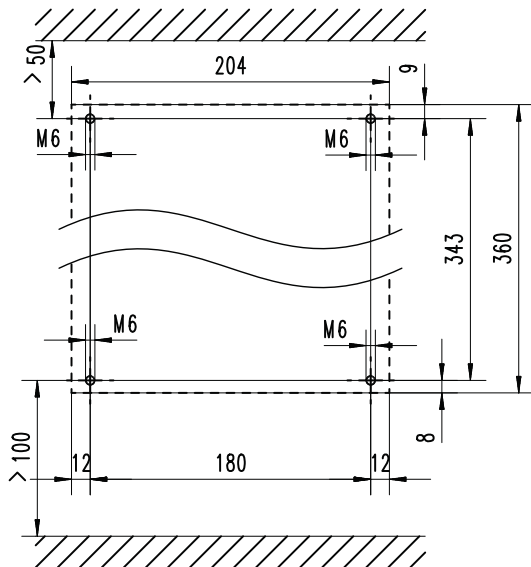
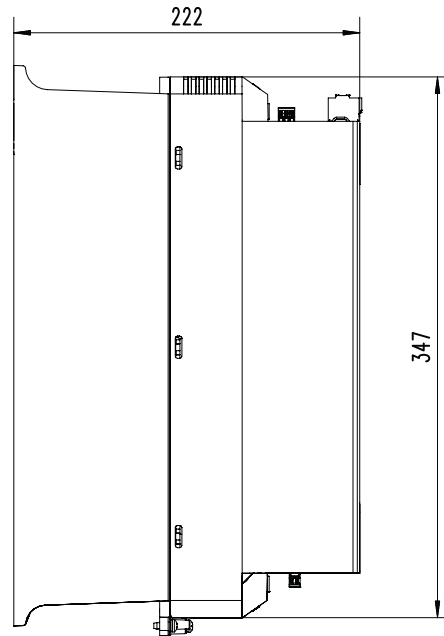
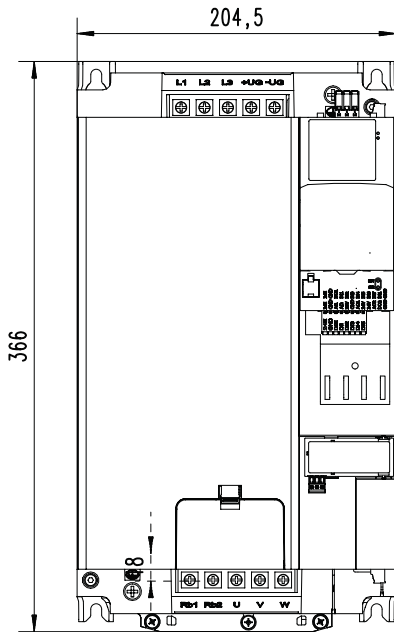

8800297



# Inverter

Technical data  
Dimensions

## 30 kW ... 45 kW

The dimensions in mm apply to:

30 kW  
i550-C30/400-3

37 kW  
i550-C37/400-3

45 kW  
i550-C45/400-3

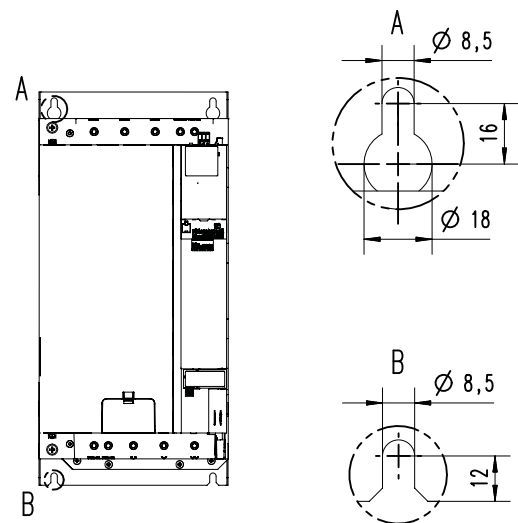
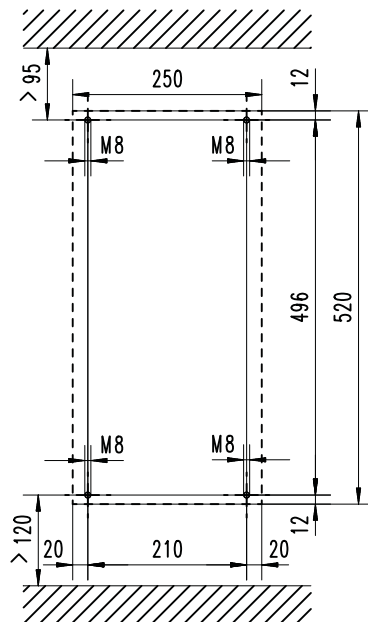
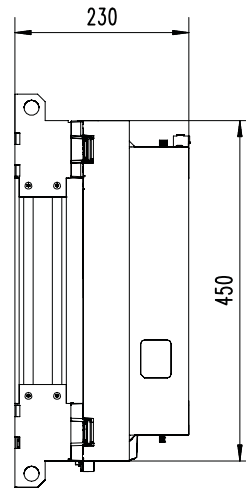
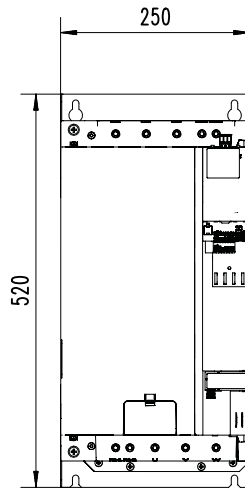

8800313

# Inverter

Product extensions  
Overview



## Product extensions

### Overview

The inverters can be easily integrated into the machine. The scalable product extensions serve to flexibly match the required functions to your application.

The control unit with standard I/O can be extended with different networks.

The control unit with application I/O provides additional inputs and outputs (I/Os). A network component is not available.

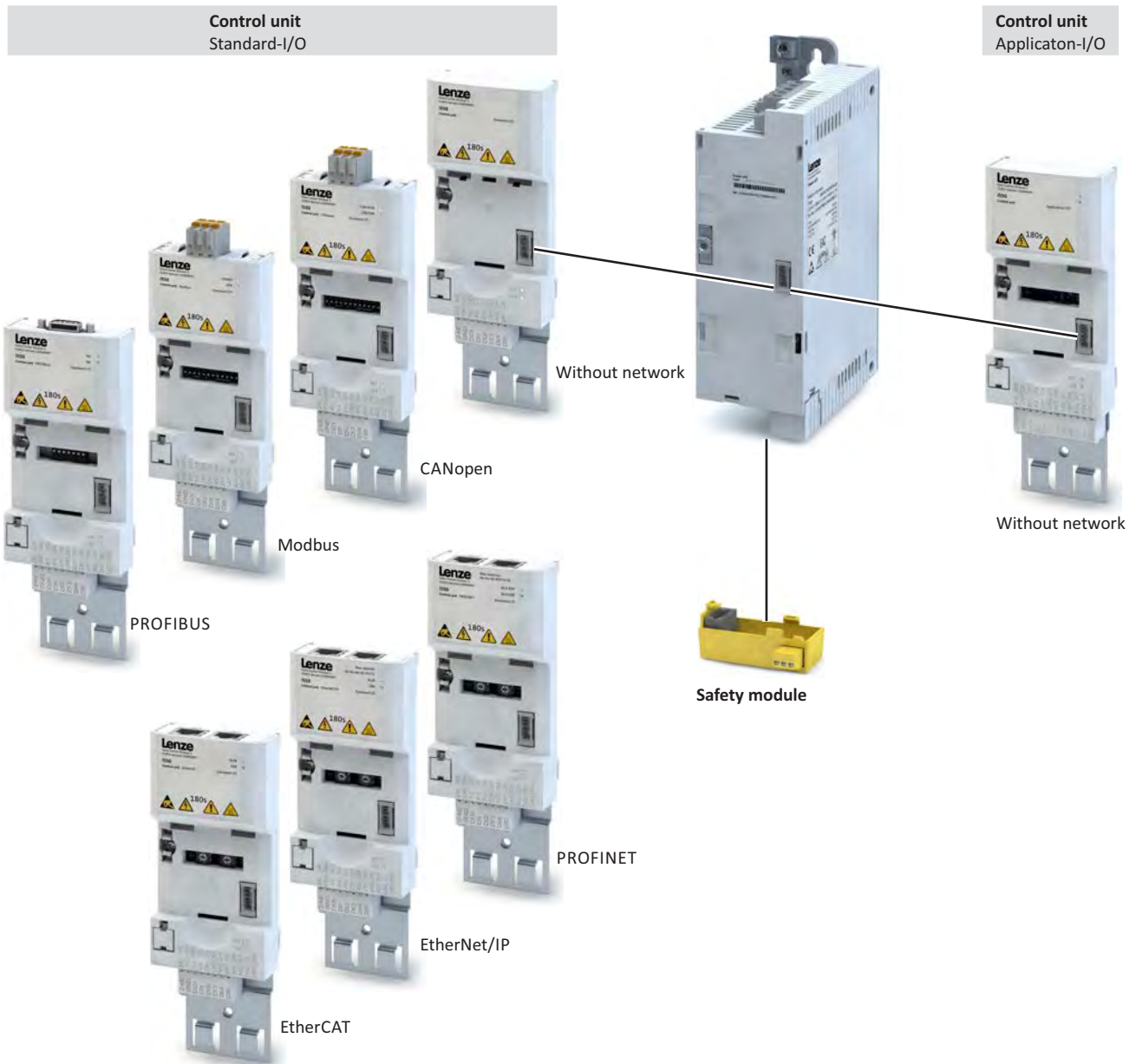





## I/O extensions

### Standard-I/O

The standard I/O provides the inverter with analog and digital inputs and outputs and is designed for standard applications. The standard I/O is available with different networks.

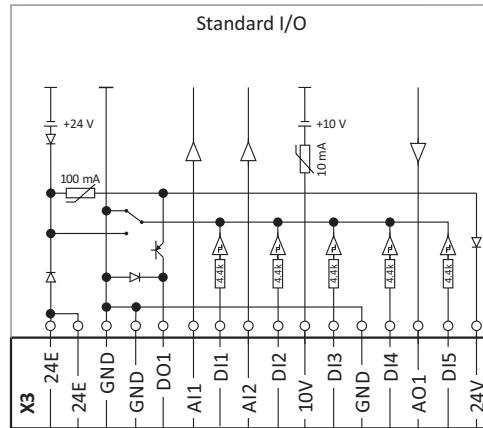

Digital inputs	Terminal X3: DI1, DI2, DI3, DI4, DI5	DI3/DI4 can be optionally used as frequency or encoder input. HIGH active/LOW active switchable
Digital outputs	Terminal X3: DO1	
Analog inputs	Terminal X3: AI1, AI2	can be optionally used as voltage or current input.
Analog outputs	Terminal X3: AO1	Can be optionally used as voltage or current output.
24-V input	Terminal X3: 24E	Mains-independent DC supply of the control electronics (incl. communication)
10-V output	Terminal X3: 10V	Reference voltage or setpoint potentiometer
24-V output	Terminal X3: 24V	
Reference potential	Terminal X3: GND	
Connection system	Pluggable spring terminal	

# Inverter

Product extensions  
I/O extensions



## Application I/O

In addition to the standard I/O, the application I/O provides the inverter with more digital and analog inputs and is intended for individual applications. The combination with network components is not available.

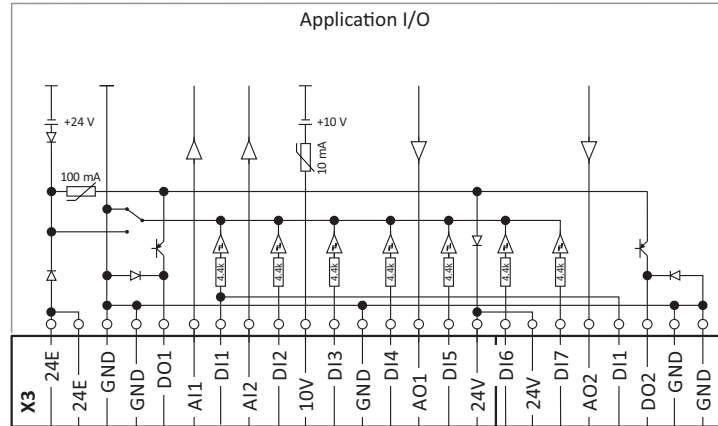

Digital inputs	Terminal X3: DI1, DI2, DI3, DI4, DI5, DI6, DI7	DI3/DI4 can be optionally used as frequency or encoder input. HIGH active/LOW active switchable
Digital outputs	Terminal X3: DO1, DO2	
Analog inputs	Terminal X3: AI1, AI2	can be optionally used as voltage or current input.
Analog outputs	Terminal X3: AO1, AO2	Can be optionally used as voltage or current output.
24-V input	Terminal X3: 24E	Mains-independent DC supply of the control electronics (incl. communication)
10-V output	Terminal X3: 10V	Reference voltage or setpoint potentiometer
24-V output	Terminal X3: 24V	
Reference potential	Terminal X3: GND	
Connection system	pluggable spring terminal	



## Data of control connections

### Digital inputs

Switching type		PNP, NPN	Parameterisable
PNP switching level			
LOW	V	< +5	IEC 61131-2, type 1
HIGH	V	> +15	
NPN switching level			
LOW	V	> +15	
HIGH	V	< +5	
Input resistance	kΩ	4.6	
Cycle time	ms	1	can be changed by software filtering
Electric strength of external voltage	V	± 30	

Frequency input			
Connection		X3/DI3, X3/DI4	
Frequency range	kHz	0 ... 100	

Encoder input			
Type		Incremental HTL encoder	
Two-track connection		X3/DI3 X3/DI4	Track A Track B
Frequency range	kHz	0 ... 100	

### Digital outputs

Switching level			
LOW	V	< +5	IEC 61131-2, type 1
HIGH	V	> +15	
max. output current	mA	100	Total current for DO1 and 24V
Cycle time	ms	1	
Short-circuit strength		Unlimited period	
Electric strength of external voltage	V	± 30	
Polarity reversal protection		Integrated freewheeling diode for switching the inductive load	
Overload behaviour		Reduced voltage or periodic switch-off/on	
Reset or switch-on behaviour		Output is switched off	LOW

# Inverter

Product extensions  
I/O extensions



## Analog inputs

Cycle time	ms	1	
Resolution of A/D converter	Bit	12	
Operation as voltage input			
Connection designation		X3/AI1, X3/AI2	
Input voltage DC	V	-10 ... 10	
Input resistance	kΩ	70	
Accuracy	mV	± 50	Typical
Input voltage in case of open circuit	V	- 0.2 ... 0.2	Display "0"
Electric strength of external voltage	V	± 24	
Operation as current input			
Connection designation		X3/AI1, X3/AI2	
Input current	mA	0 ... 20 4 ... 20	open-circuit monitored
Accuracy	mA	± 0.1	Typical
Input current in case of open circuit	mA	< 0.1	Display "0"
Input resistance	Ω	< 250	
Electric strength of external voltage	V	± 24	

## Analog outputs

Short-circuit strength		Unlimited period	
Electric strength of external voltage	V	+ 24V	
Operation as voltage output			
Resolution of D/A converter	Bit	12	
Output voltage DC	V	0 ... 10	
max. output current	mA	5	
Max. capacitive load	μF	1	
Accuracy	mV	± 100	Typical
Operation as current output			
Output current	mA	0 ... 20 4 ... 20	open-circuit monitored
Accuracy	mA	± 0.2	Typical

## 10-V output

Use		Primarily for the supply of a potentiometer (1 ... 5 kΩ)	
Output voltage DC			
Typical	V	10	
Accuracy	mV	± 100	
Max. output current	mA	10	
Max. capacitive load	μF	1	
Short-circuit strength		Unlimited period	
Electric strength of external voltage	V	+ 24	



### 24-V input

Use		Input for mains-independent DC supply of the control electronics (incl. communication)	
Input voltage DC			
Typical	V	24	IEC 61131-2
Area	V	19.2 ... 28.8	
Input current			
Typical	A	0.150	
Max.	A	1.0	When switching on for 50 ms
Capacity to be charged	μF	440	
Polarity reversal protection		When polarity is reversed: No function and no destruction	
Suppression of voltage pulses		Suppressor diode 30 V, bidirectional	
Power supply unit		SELV/PELV	Externally to create a mains-independent DC supply
Max. current	A	8.0	While looping-through

### 24-V output

Use		Primarily for the supply of digital inputs	
Output voltage DC			
Typical	V	24	
Area	V	16 ... 28	
max. output current	mA	100	Total current for DO... and 24V
Short-circuit strength		Unlimited period	
Electric strength of external voltage	V	+ 30	
Excess current release		Automatically resettable	

Terminal description		Control terminals
Connection		X3
Connection type		Spring terminal
Min. cable cross-section	mm <sup>2</sup>	0.5
Max. cable cross-section	mm <sup>2</sup>	1.5
Stripping length	mm	9
Tightening torque	Nm	-
Required tool		0.4 x 2.5

# Inverter

Product extensions  
More control connections



## More control connections

### Relay output



Relay is not suitable for direct switching of a electromechanical holding brake!

Use a corresponding suppressor circuit in case of an inductive or capacitive load!

Connection		Terminal X9: COM	Centre contact (common)	
		Terminal X9: NC	Normally-closed contact	
		Terminal X9: NO	Normally-open contact	
Minimum DC contact load				
	Voltage	V	10	A correct switching of the relay contacts needs both values to be exceeded simultaneously.
	Current	mA	10	
Switching voltage/switching current				
Maximum	AC 240 V	A	3	According to UL: General Purpose
	DC 24 V	A	2	According to UL: Resistive
	DC 240 V	A	0.16	

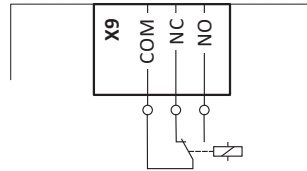

Terminal description		Relay output
Connection		X9
Connection type		Screw terminal
Min. cable cross-section	mm <sup>2</sup>	0.5
Max. cable cross-section	mm <sup>2</sup>	1.5
Stripping length	mm	6
Tightening torque	Nm	0.2
Required tool		0.4 x 2.5



**PTC input**



In the Lenze setting, motor temperature monitoring is activated! In the delivery status, there is a wire jumper between the terminals T1 and T2. Before connecting a thermal sensor, remove the wire jumper.

Use	Connection of PTC or thermal contact
Connection	Terminal X109: T1 Terminal X109: T2
Sensor types	PTC single sensor (DIN 44081) PTC triple sensor (DIN 44082) Thermal contact

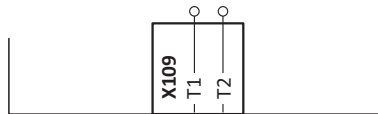

Terminal description		PTC input
Connection		X109
Connection type		Screw terminal
Min. cable cross-section	mm <sup>2</sup>	0.5
Max. cable cross-section	mm <sup>2</sup>	1.5
Stripping length	mm	6
Tightening torque	Nm	0.2
Required tool		0.4 x 2.5

# Inverter

Product extensions  
Networks



## Networks

### CANopen

CANopen is an internationally approved communication protocol which is designed for commercial and industrial automation applications. High data transfer rates in connection with efficient data formatting provide for the coordination of motion control devices in multi-axis applications.

General information			
Version		Optional Integrated in standard I/O	
DC supply of the control electronics and optional fieldbus		internally via the inverter Mains-dependent	
alternative external mains-independent supply	V	24 DC at X3/24E...GND	

Bus-related information			
Name		CANopen CiA 301 V4.2.0	
Communication medium		CAN cable in accordance with ISO 11898-2	
Use		Connection of the inverter to a CANopen network	
Connection system		pluggable double spring terminal	
Status display		2 LEDs	
Connection designation		X216: CH, CL, CG	

Technical data			
Bus terminating resistor	$\Omega$	120	Terminated on both sides
integrated bus terminating resistor		Yes	Activation via DIP switch
Network topology			
without repeater		Line	
with repeater		Line or tree	
Station			
Type		Slave	
Max. number without repeater		127	per bus segment, incl. host system
Address		1 ... 127	Adjustable via code or DIP switch
Baud rate	kbps	20, 50, 125, 250, 500, 800 or 1000	Adjustable via code or DIP switch
Max. bus length	m	2500, 1000, 500, 250, 100, 50 or 25	Total cable length depends on the baud rate
Max. cable length between two nodes		not limited, the max. bus length is decisive	
Process data			
Transmit PDOs		3 TPDOs with 1 ... 8 bytes (adjustable)	
Receive PDOs		3 RPDOs with 1 ... 8 bytes (adjustable)	
Transmission mode for TPDOs			
With change of data		Yes	
Time-controlled, multiple of	ms	10	
After reception		1 ... 240 sync telegrams	
Parameter data			
SDO channels		Max. 2 servers	





Communication time			
Communication time depends on		Processing time in the inverter	Time between the start of a request and arrival of the response
		Telegram runtime (baud rate, telegram length)	
		Nesting depth of the network	
		Bus load	

Processing time of process data			
Update cycle, multiple of	ms	10	In the inverter
Processing time	ms	0 ... 1	
application task runtime of the technology application used (tolerance)	ms	1 ... x	

Other data			
Note		There are no interdependencies between parameter data and process data.	

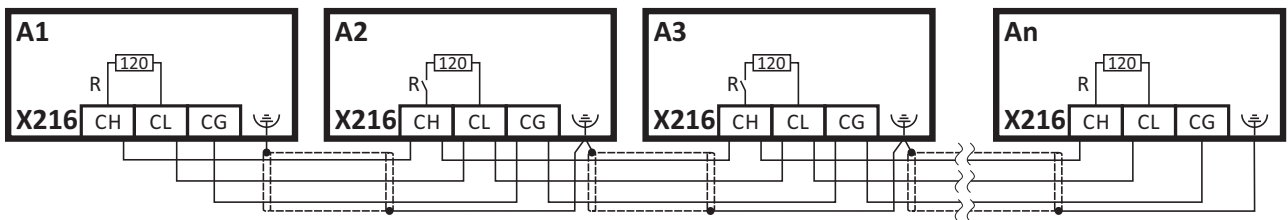

Fig. 2: Wiring example: CANopen network

Terminal description		CANopen
Connection		X216
Connection type		Spring terminal
Min. cable cross-section	mm <sup>2</sup>	0.5
Max. cable cross-section	mm <sup>2</sup>	2.5
Stripping length	mm	10
Tightening torque	Nm	-
Required tool		0.4 x 2.5

# Inverter

Product extensions  
Networks



## Modbus

Modbus is an internationally approved, asynchronous, serial communication protocol, designed for commercial and industrial automation applications.

General information			
Version		Optional Integrated in standard I/O	
DC supply of the control electronics and optional fieldbus		internally via the inverter Mains-dependent	
alternative external mains-independent supply	V	24 DC at X3/24E...GND	

Bus-related information			
Name		Modbus RTU	
Communication medium		RS485 (EIA)	
Use		Connection of the inverter to a Modbus network	
Connection system		pluggable double spring terminal	
Status display		2 LEDs	
Connection designation		X216: TA, TB, COM	

Technical data			
Communication profile		Modbus RTU	
Bus terminating resistor	$\Omega$	120	Terminated on both sides
integrated bus terminating resistor		Yes	Activation via DIP switch
Network topology			
Without repeater		Line	
Station			
Type		Slave	
Max. number without repeater		32	per bus segment, incl. host system
Max. number with repeater		90	
Address		1 ... 247	Adjustable via code or DIP switch
Baud rate	kbps	4.8 ... 115	Adjustable via code or DIP switch, alternatively automatic detection via DIP switch can be activated
Max. cable length	m	12 ... 600	Per bus segment, depending on the baud rate and the used cable type
Max. cable length between two nodes		not limited, the max. bus length is decisive	
Data channel			
SDO channels		Max. 2 servers, with 1 ... 8 bytes	Supported functions: Read Holding Registers Preset Single Register Preset Multiple Registers Read/Write 4 x registers



Communication time			
Communication time depends on		Processing time in the inverter	Time between the start of a request and arrival of the response
		Telegram runtime (baud rate, telegram length)	
		Nesting depth of the network	
		Bus load	

Processing time of process data			
Update cycle, multiple of	ms	10	In the inverter
Processing time	ms	0 ... 1	
application task runtime of the technology application used (tolerance)	ms	1 ... x	

Other data			
Note		There are no interdependencies between parameter data and process data.	

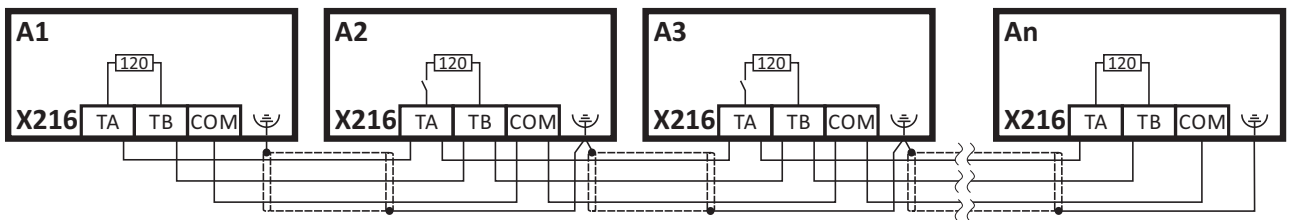

Fig. 3: Wiring example: Modbus network

Terminal description		Modbus
Connection		X216
Connection type		Spring terminal
Min. cable cross-section	mm <sup>2</sup>	0.5
Max. cable cross-section	mm <sup>2</sup>	2.5
Stripping length	mm	10
Tightening torque	Nm	-
Required tool		0.4 x 2.5

# Inverter

Product extensions  
Networks



## PROFIBUS

PROFIBUS is a common fieldbus for the connection of inverters to different control systems in plants.

General information			
Version		Optional Integrated in standard I/O	
DC supply of the control electronics and optional fieldbus		internally via the inverter Mains-dependent	
alternative external mains-independent supply	V	24 DC at X3/24E...GND	

Bus-related information			
Name		PROFIBUS-DP	
Communication medium		RS485	
Use		Connection of the inverter to a PROFIBUS-DP network	
Connection system		9-pole Sub-D socket	
Status display		2 LEDs	
Connection designation		X226: Pin 1 ... 9	

Technical data			
Communication profile		PROFIBUS-DP-V0	DRIVECOM parameter data channel
		PROFIBUS-DP-V1	PROFIdrive parameter data channel
Bus terminating resistor	$\Omega$	120	Terminated on both sides
integrated bus terminating resistor		No	
Network topology			
Without repeater		Line	
With repeater		-	
Station			
Type		Slave	
Max. number without repeater		32	per bus segment, incl. host system
Max. number with repeater		125	
Address		1 ... 127	Adjustable via code or DIP switch
Baud rate	kbps	9.6 ... 12000	Automatic detection for cable type A (EN 50170)
Max. bus length	m	1200	Per bus segment, depending on the baud rate and the used cable type
Max. cable length between two nodes		not limited, the max. bus length is decisive	
Process data			
PZD		1 ... 16 words (16 bits/word) in each direction	
Transmission mode			
Data length, cyclic		1 ... 16 words, process data channel + 4 words of disconnectable parameter data channel	
Identification number		0x0E550	
User data			
Cyclic (DP-V0)		4 bytes	
Acyclic (DP-V1)		Max. 240 bytes	



Communication time			
Communication time depends on		Processing time in the inverter	Time between the start of a request and arrival of the response
		Telegram runtime (baud rate, telegram length)	
		Nesting depth of the network	
		Bus load	

Processing time of process data			
Update cycle, multiple of	ms	10	In the inverter
Processing time	ms	0 ... 1	
application task runtime of the technology application used (tolerance)	ms	1 ... x	

Other data			
Note		There are no interdependencies between parameter data and process data.	

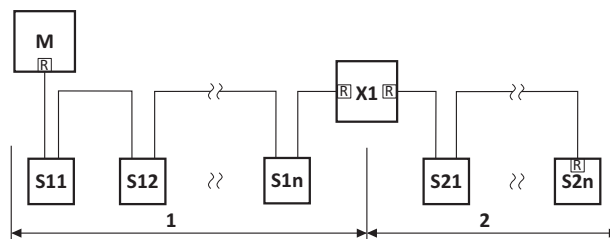

Fig. 4: Wiring example: PROFIBUS network with 2 segments

- |     |        |    |                                    |
|-----|--------|----|------------------------------------|
| M   | Master | X1 | Repeater                           |
| Sxx | Slaves | R  | Activated bus terminating resistor |

**Sub D socket 9-pin - X226**

View	Pin	Assignment	Description
	1	Shield	Additional shield connection
	2	n.c.	
	3	RxD/TxD-P	Data line-B (received data/transmitted data +)
	4	RTS	Request To Send (received data/transmitted data, no differential signal)
	5	M5V2	Reference potential (bus terminating resistor -)
	6	P5V2	5 V DC / 30 mA (bus terminating resistor +, OLM, OLP)
	7	n.c.	
	8	RxD/TxD-N	Data line-A (received data/transmitted data -)
	9	n.c.	

# Inverter

Product extensions  
Networks



## EtherCAT

EtherCAT is a common fieldbus for the connection of inverters to different control systems in plants.

General information			
Version		Optional Integrated in standard I/O	
DC supply of the control electronics and optional fieldbus		internally via the inverter Mains-dependent	
alternative external mains-independent supply	V	24 DC at X3/24E...GND	

Bus-related information			
Name		EtherCAT	
Communication medium		Ethernet 100 Mbps, full duplex	
Use		Connection of the inverter to an EtherCAT network	
Connection system		RJ45	
Status display		2 LEDs	
Connection designation		In: X246 Out: X247	

Technical data			
Communication profile		EtherCAT	
		CANopen over EtherCAT (CoE)	
Bus terminating resistor	$\Omega$	not required	
integrated bus terminating resistor		No	
Network topology			
Without repeater		Line, switch	
With repeater		-	
Station			
Type		EtherCAT slave	
Max. number		65535	In the entire network
Address			Adjustable via parameter
Max. cable length	m	-	Not limited The length between the TNs is decisive.
Max. cable length between two nodes	m	100	
Process data			
Transmit PDOs		16 words	
Receive PDOs		16 words	
Cycle times	ms	integer multiple of 1	



## EtherNet/IP

EtherNET/IP is a common fieldbus for the connection of inverters to different control systems in plants.

General information			
Version		Optional Integrated in standard I/O	
DC supply of the control electronics and optional fieldbus		internally via the inverter Mains-dependent	
alternative external mains-independent supply	V	24 DC at X3/24E...GND	

Bus-related information			
Name		EtherNet/IP	
Communication medium		Ethernet 10 Mbps, 100 Mbps, half duplex, full duplex	
Use		Connection of the inverter to an Ether- Net/IP network	
Connection system		RJ45	
Status display		2 LEDs	
Connection designation		In: X266 Out: X267	

Technical data			
Communication profile		EtherNet/IP	
		AC Drive	
Bus terminating resistor		not required	
integrated bus terminating resistor		No	
Network topology			
Without repeater		Tree, star and line	
With repeater		-	
Station			
Type		Adapter (slave)	
Max. number		254	Per subnetwork
Address		Station name	
Max. cable length	m	-	Not limited The length between the TNs is decisive.
Max. cable length between two nodes	m	100	
Process data			
Transmit PDOs		16 words	
Receive PDOs		16 words	
Cycle time	ms	> 4	
Switching method		Store-and-Forward Cut-Through	
Switch latency	µs	~ 125	At maximum telegram length
Other data		Additional TCP/IP channel	

# Inverter

Product extensions  
Networks



## PROFINET

PROFINET is a common fieldbus for the connection of inverters to different control systems in plants.

General information			
Version		Optional Integrated in standard I/O	
DC supply of the control electronics and optional fieldbus		internally via the inverter Mains-dependent	
alternative external mains-independent supply	V	24 DC at X3/24E...GND	

Bus-related information			
Name		PROFINET RT	
Communication medium		Ethernet 100 Mbps, full duplex	
Use		Connection of the inverter to a PROFINET network	
Connection system		RJ45	
Status display		2 LEDs	
Connection designation		In: X256 Out: X257	

Technical data			
Communication profile		PROFINET RT	
Bus terminating resistor		not required	
integrated bus terminating resistor		No	
Network topology			
Without repeater		Tree, star and line	
With repeater		-	
Station			
Type		I/O device with real time (RT) communication properties	
Max. number		255	Per subnetwork
Address		Station name	
Max. cable length	m	-	Not limited The length between the TNs is decisive.
Max. cable length between two nodes	m	100	
Process data			
Transmit PDOs		16 words	
Receive PDOs		16 words	
Cycle time	ms	2,4,8,16	
Switching method		Store-and-Forward	
Switch latency	µs	~ 125	At maximum telegram length
Other data		Additional TCP/IP channel	





## Functional safety

### Safety module

Integrated safety provides the conditions in the controls and drives to optimise the safety functions. Planning and installation expenditure is reduced. In comparison to the use of standard safety engineering, integrated safety increases machine functionality and availability.

The integrated safety system can be used for the protection of persons working on machines in accordance with the Machinery Directive.

The safety module serves to use the "safe torque off" (STO) safety function.

The motion functions are continued to be executed by the inverter. The integrated safety system monitors the safe compliance with the limit values and provides the safe inputs. If monitored limit values are exceeded, the integrated safety system starts control functions in the inverter according to EN 60204-1 to counteract possible errors.



Further information can be obtained from the "Functional safety" configuration document.



Safety module	
Order code	Version
ISMASA0000000S	STO (Safe torque off) Performance Level d Safety Class SIL 2

Terminal description		Safety STO
Connection		X1
Connection type		Screw terminal
Min. cable cross-section	mm <sup>2</sup>	0.5
Max. cable cross-section	mm <sup>2</sup>	1.5
Stripping length	mm	6
Tightening torque	Nm	0.2
Required tool		0.4 x 2.5

# Inverter

Accessories  
Overview



## Accessories

### Overview

A package of accessories optimally matched to the inverter is available for your applications.

Moreover, the pluggable modules make commissioning and diagnostics easier.

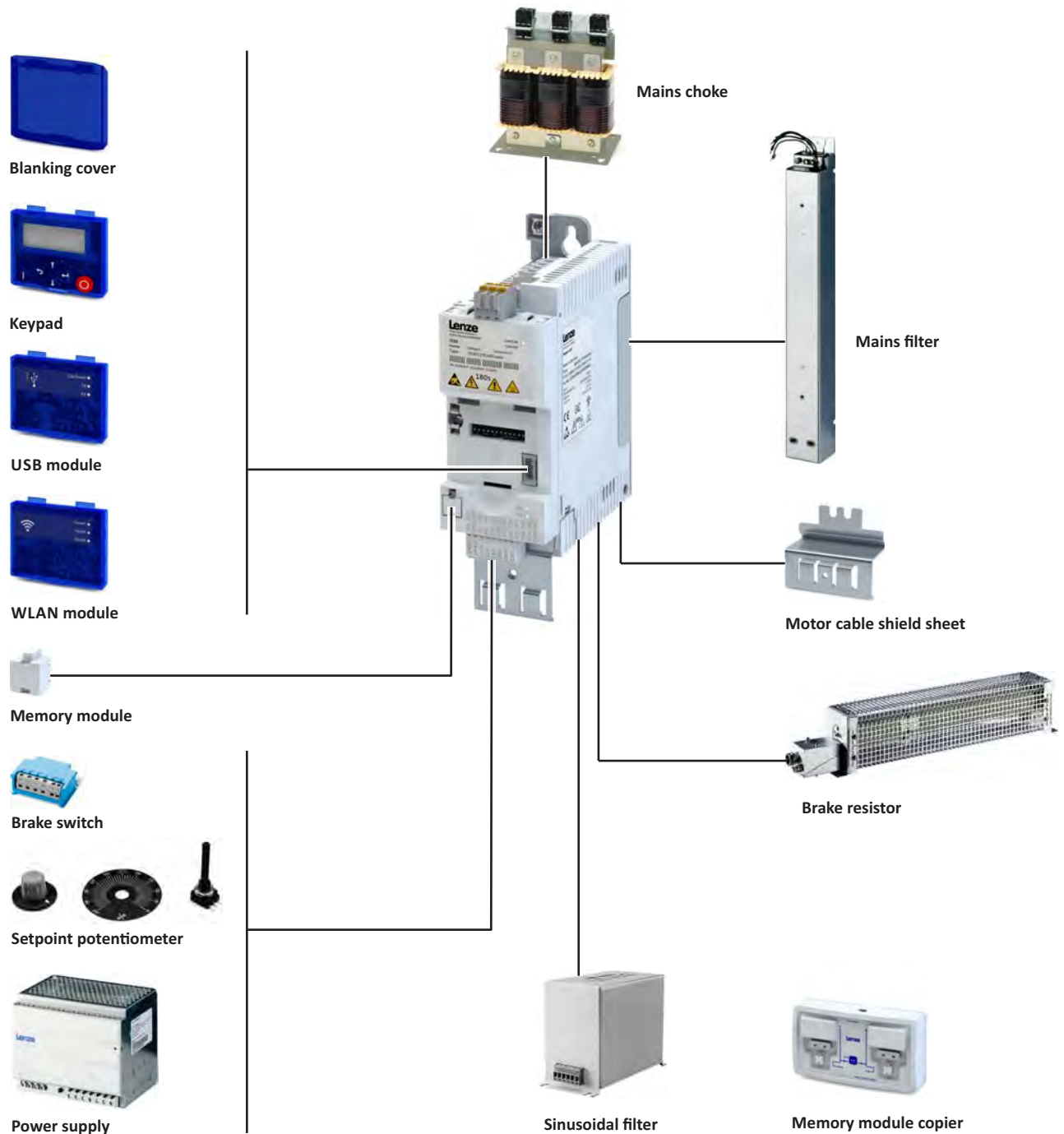

Further accessories: terminal strips and latching terminals for the shield sheet of the control unit.



## Operation and diagnostics

### Keypad

Parameter setting and diagnostics

Thanks to the intuitive operating structure, the navigation keys allow a quick and easy access to the most important parameters, either to configure functions or to query current values. Parameters and actual values are indicated on the easy-to-read display.

The start and stop keys serve to switch on and off the motor via the keypad.



Keypad	
Order code	Version
i5MADK0000000S	16-digit LED display Display in German/English

### USB module

Interface to the PC

The USB 2.0-connecting cable is used to connect the inverter with the "EASY Starter" Lenze Engineering Tool. The "EASY Starter" serves to configure the inverter via graphical interfaces. They create diagnostics with trend functions or monitor parameter values.

Parameterising without supplying the inverter with voltage: If you connect the inverter directly to the PC without a hub, the USB interface of the PC is sufficient for the voltage supply.

You need a USB 2.0-connecting cable (A plug to micro-B plug) to connect the USB module with the PC.



USB module	
Order code	Version
I5MADU0000000S	Parameter setting without voltage supply of the inverter USB 2.0 connecting cable required

Connecting cable	
Order code	Version
EWL0085	2.5 m
EWL0086	5 m

# Inverter

Accessories  
Operation and diagnostics



## WLAN module

The wireless interface

Wireless communication via a computer with the Lenze "EASY Starter" Engineering Tool or the Lenze Smart keypad app for Android smartphones.

The app is recommended for adapting easy applications. The clearly arranged user interface of the app guides you intuitively and safely through all the menus.

The WLAN module is available as of May 2016.



WLAN module	
Order code	Version
IS5MADW0000000S	For computers with the Lenze "EASY Starter" Engineering Tool For Android smartphones Operation is similar to the one of the keypad

The Lenze Smart keypad app can be found in the Google Play Store.



## Blanking cover

Protection and optics

The blanking cover protects the terminals and provides for a uniform optics if no other module is plugged on.



Blanking cover		
Order code	Version	VPE
		Piece
IS2AA0000M	Protection against dust Uniform optics	4



### Setpoint potentiometer

For the external selection of an analog setpoint.

The setpoint selection (e.g. motor speed) can be manually set via the external potentiometer. The setpoint potentiometer is connected to the analog input terminals of the inverter.

The position is displayed on the scale via the rotary knob.

The components have to be ordered separately.



Setpoint potentiometer		
Order code	Name	Version
ERPD0010K0001W	Potentiometer	10 kΩ/1 W
ERZ0001	Rotary knob	Diameter 36 mm
ERZ0002	Scale	Scale 0 ... 100 %, Diameter 62 mm

### Memory modules

For standard set-up, Lenze offers its customers multipacked, unwritten memory modules (EPM). Together with the EPM copier, the EPMs can be duplicated at any place.

A memory module is included in the scope of supply of the inverter.



Memory module		
Order code	Version	VPE
		Piece
I0MAPA0000000M	Easily pluggable Duplicate data set with memory module copier	12

### Memory module copier

For duplicating data on memory modules for a faster standard set-up.

The memory module copier is a copying system for all memory modules from Lenze. With the help of simple optical user guidance, the data of a module is copied quickly and reliably to another memory module.



Memory module copier	
Order code	Version
EZAEDE1001	Data set copier for memory modules

# Inverter

Accessories  
Brake resistors



---

## Brake resistors

To decelerate greater moments of inertia or with a longer operation in generator mode an external brake resistor is required.

While the speed value is reduced by the inverter, the motor operates as generator and supplies energy to the inverter. The brake resistor absorbs the produced brake energy and converts it into heat.





# Inverter

Accessories  
Brake resistors

Inverter	Brake resistor			
	Order code	Rated resistance	Rated power	Thermal capacity
		Ω	W	kWs
i550-C0.25/230-1	ERBM180R050W	180	50	7.5
i550-C0.37/230-1				
i550-C0.55/230-1	ERBM100R100W	100	100	15
i550-C0.75/230-1				
i550-C1.1/230-1	ERBP033R200W	33	200	30
	ERBP033R300W		300	45
i550-C1.5/230-1	ERBP033R200W		200	30
i550-C2.2/230-1	ERBP033R300W		300	45
	ERBP033R200W		200	30
i550-C0.25/230-2	ERBM180R050W		180	50
i550-C0.37/230-2				
i550-C0.55/230-2	ERBM100R100W	100	100	15
i550-C0.75/230-2				
i550-C1.1/230-2	ERBP033R300W	33	300	45
	ERBP033R200W		200	30
i550-C1.5/230-2	ERBP033R300W		300	45
i550-C2.2/230-2	ERBP033R200W		200	30
	ERBP033R300W		300	45
i550-C0.37/400-3	ERBM390R100W		390	100
i550-C0.55/400-3				
i550-C0.75/400-3				
i550-C1.1/400-3	ERBP180R200W	180	200	30
	ERBP180R300W		300	45
i550-C1.5/400-3	ERBP180R200W		200	30
i550-C2.2/400-3	ERBP180R300W		300	45
	ERBP180R200W		200	30
i550-C3.0/400-3	ERBP082R200W		82	200
	ERBS082R780W	780		117
i550-C4.0/400-3	ERBP047R200W	47	200	30
	ERBS047R400W		400	60
	ERBS047R800W		800	120
i550-C5.5/400-3	ERBP047R200W		200	30
	ERBS047R400W		400	60
	ERBS047R800W		800	120
i550-C7.5/400-3	ERBP027R200W	27	200	30
	ERBS027R600W		600	90
	ERBS027R01K2		1200	180
i550-C11/400-3	ERBP027R200W		200	30
	ERBS027R600W		600	90
	ERBS027R01K2		1200	180
i550-C15/400-3	ERBS018R800W	18	800	120
	ERBS018R01K4		1400	210
	ERBS018R02K8		2800	420
	ERBG018R04K3		4300	645
i550-C18/400-3	ERBS015R800W	15	800	120
	ERBS015R01K2		1200	180
	ERBS015R02K4		2400	420
	ERBG015R06K2		6200	930
i550-C22/400-3	ERBS015R800W	15	800	120
	ERBS015R01K2		1200	180
	ERBS015R02K4		2400	420
	ERBG015R06K2		6200	930

# Inverter

Accessories

Brake resistors



Inverter	Brake resistor			
	Order code	Rated resistance $\Omega$	Rated power W	Thermal capacity kWs
i550-C30/400-3	ERBG075D01K9	7.5	1900	285
i550-C37/400-3				
i550-C45/400-3				





---

### Mains chokes

Mains chokes reduce the effects of the inverter on the supplying mains.

The switching operations in the inverter cause high-frequency interferences that will be transmitted unfiltered to the supplying mains. Mains chokes smooth the steep and pulse-like curves coming from the Inverter and make them more sinusoidal. Moreover, the effective mains current is reduced and thus energy is saved.

Mains chokes can be used without restrictions in conjunction with RFI filters.

Please note that the use of a mains choke slightly reduces the mains voltage at the input of the inverter. The typical voltage drop across the mains choke is around 4 %.



---

Inverters from 22 kW must always be used together with mains chokes.

---



# Inverter

Accessories  
Mains chokes



Inverter	Mains choke		
	Order code	Rated current	Inductance
		A	mH
i550-C0.25/230-1	ELN1-0900H005	5	9
i550-C0.37/230-1			
i550-C0.55/230-1	ELN1-0500H009	9	5
i550-C0.75/230-1			
i550-C1.1/230-1	ELN1-0250H018	18	2.5
i550-C1.5/230-1			
i550-C2.2/230-1			
i550-C0.25/230-2	ELN1-0900H005	5	9
	EZAELN3002B153	2	14.7
i550-C0.37/230-2	ELN1-0900H005	5	9
	EZAELN3004B742	4	7.35
i550-C0.55/230-2	ELN1-0500H009	9	5
	EZAELN3004B742	4	7.35
i550-C0.75/230-2	ELN1-0500H009	9	5
	EZAELN3006B492	6	4.9
i550-C1.1/230-2	ELN1-0250H018	18	2.5
	EZAELN3006B492	6	4.9
i550-C1.5/230-2	ELN1-0250H018	18	2.5
	EZAELN3008B372	8	3.68
i550-C2.2/230-2	ELN1-0250H018	18	2.5
	EZAELN3010B292	10	2.94
i550-C0.37/400-3	EZAELN3002B153	2	14.7
i550-C0.55/400-3	EZAELN3004B742	4	7.35
i550-C0.75/400-3			
i550-C1.1/400-3			
i550-C1.5/400-3			
i550-C2.2/400-3	EZAELN3006B492	6	4.9
i550-C3.0/400-3	EZAELN3008B372	8	3.68
i550-C4.0/400-3	EZAELN3010B292	10	2.94
i550-C5.5/400-3	EZAELN3016B182	16	1.84
i550-C7.5/400-3	EZAELN3020B152	20	1.47
i550-C11/400-3	EZAELN3025B122	25	1.18
i550-C15/400-3	EZAELN3035B841	35	0.84
i550-C18/400-3	EZAELN3045B651	45	0.65
i550-C22/400-3	EZAELN3050B591	50	0.59
i550-C30/400-3	EZAELN3063B471	63	0.47
i550-C37/400-3	EZAELN3080B371	80	0.37
i550-C45/400-3	EZAELN3090B331	90	0.33



### RFI filters / Mains filters

RFI and mains filters are used to ensure compliance with the EMC requirements of European Standard EN 61800-3. This standard defines the EMC requirements for electrical drive system in various categories.

#### Category C1

Category C1 is applicable in public networks (residential areas). Category C1 corresponds to Class B with regard to the limit values of Class B in line with EN 55011.

#### Category C2

Category C2 is applicable in industrial premises, use in residential areas is left to the expert and responsible user's discretion. With regard to limit values, the category C2 corresponds to Class A in line with EN 55011.



When working with stricter line-bound noise emission requirements which cannot be met using the radio interference suppression measures integrated in the inverter, external filters can be used. The filters can be installed below or next to the inverter.

If necessary, the internal filters have to be deactivated when external filters are used. For this purpose, remove the IT screws of the inverters.



### Comparison of internal/external RFI filter

RFI filters		Internal	Low Leakage	Short Distance	Long Distance
Version		Standard	For installation in mobile systems.	Optimised for low leakage current.	Optimised for long motor cable Switching frequency 4 kHz and 8 kHz
Noise emission		Cable-guided and radiated	Cable-guided	Cable-guided	Cable-guided
Leakage current		Earth-leakage circuit breaker 300 mA	< 3.5 mA	Earth-leakage circuit breaker 30 mA	Earth-leakage circuit breaker 300 mA
Motor cable length shielded max.					
Category C1	m	3	5	25	50
Category C2	m	20	-	50	100

# Inverter

Accessories  
RFI filters / Mains filters



Mains connection			1-phase, 230 V			
Inverter			i550-C0.25/230-1 i550-C0.37/230-1	i550-C0.55/230-1 i550-C0.75/230-1	i550-C1.1/230-1 i550-C1.5/230-1 i550-C2.2/230-1	
Without RFI filter						
With-out EMC	Shielded motor cable length	m	50	50	50	
	Unshielded motor cable length	m	100	100	200	
With integrated RFI filter						
C1	Shielded motor cable length	m	3	3	3	
C2		m	15	20	20	
	Earth-leakage circuit breaker	mA	30	30	30	
RFI filter Low Leakage						
C1	Shielded motor cable length	m	5	5	5	
	Earth-leakage circuit breaker	mA	30	30	30	
RFI filter Short Distance						
C1	Shielded motor cable length	m	25	25	25	
C2		m	50	50	50	
	Earth-leakage circuit breaker	mA	30	30	30	
RFI filter Long Distance						
C1	Shielded motor cable length	m	50	50	50	
C2		m	50	50	50	
	Earth-leakage circuit breaker	mA	300	300	300	

Mains connection			3-phase, 400 V			
Inverter			i550-C0.37/400-3	i550-C0.55/400-3 i550-C0.75/400-3	i550-C1.1/400-3 i550-C1.5/400-3 i550-C2.2/400-3	i550-C3.0/400-3 i550-C4.0/400-3 i550-C5.5/400-3
Without RFI filter						
With-out EMC	Shielded motor cable length	m	15	50	50	100
	Unshielded motor cable length	m	30	100	200	200
With integrated RFI filter						
C1	Shielded motor cable length	m	3	3	-	-
C2		m	15	20	20	20
	Earth-leakage circuit breaker	mA	30	30	30	300
RFI filter Low Leakage						
C1	Shielded motor cable length	m	-	-	-	-
	Earth-leakage circuit breaker	mA	-	-	-	-
RFI filter Short Distance						
C1	Shielded motor cable length	m	15	25	25	25
C2		m	15	50	50	50
	Earth-leakage circuit breaker	mA	30	30	30	30
RFI filter Long Distance						
C1	Shielded motor cable length	m	15	50	50	50
C2		m	15	50	50	100
	Earth-leakage circuit breaker	mA	300	300	300	300



# Inverter

Accessories  
RFI filters / Mains filters

Mains connection			3-phase, 400 V		
Inverter			i550-C7.5/400-3 i550-C11/400-3	i550-C15/400-3 i550-C18.5/400-3 i550-C22/400-3	i550-C30/400-3 i550-C37/400-3 i550-C45/400-3
Without RFI filter					
With-out EMC	Shielded motor cable length	m	100	100	100
	Unshielded motor cable length	m	200	200	200
With integrated RFI filter					
C1	Shielded motor cable length	m	-	-	-
C2		m	20	20	20
	Earth-leakage circuit breaker	mA	300	300	300
RFI filter Low Leakage					
C1	Shielded motor cable length	m	-	-	-
	Earth-leakage circuit breaker	mA	-	-	-
RFI filter Short Distance					
C1	Shielded motor cable length	m	25	-	-
C2		m	50	-	-
	Earth-leakage circuit breaker	mA	30	-	-
RFI filter Long Distance					
C1	Shielded motor cable length	m	50	50	50
C2		m	100	50	50
	Earth-leakage circuit breaker	mA	300	300	300

## Low Leakage

Inverter	RFI filters	
	Order code	Rated current A
i550-C0.25/230-1	IOFAE175B100L0000S	9
i550-C0.37/230-1		
i550-C0.55/230-1		
i550-C0.75/230-1		
i550-C1.1/230-1	IOFAE222B100L0000S	21.8
i550-C1.5/230-1		
i550-C2.2/230-1		

# Inverter

Accessories  
RFI filters / Mains filters



## Short Distance

Inverter	RFI filters	
	Order code	Rated current A
i550-C0.25/230-1	IOFAE175B100S0000S	9
i550-C0.37/230-1		
i550-C0.55/230-1		
i550-C0.75/230-1		
i550-C1.1/230-1	IOFAE222B100S0000S	21.8
i550-C1.5/230-1		
i550-C2.2/230-1		
i550-C0.37/400-3	IOFAE175F100S0000S	3.3
i550-C0.55/400-3		
i550-C0.75/400-3		
i550-C1.1/400-3	IOFAE222F100S0000S	7.3
i550-C1.5/400-3		
i550-C2.2/400-3		
i550-C3.0/400-3	IOFAE255F100S0000S	18.0
i550-C4.0/400-3		
i550-C5.5/400-3		
i550-C7.5/400-3		
i550-C11/400-3	IOFAE311F100S0000S	29.0

## Long Distance

Inverter	RFI filters	
	Order code	Rated current A
i550-C0.25/230-1	IOFAE175B100D0000S	9.0
i550-C0.37/230-1		
i550-C0.55/230-1		
i550-C0.75/230-1		
i550-C1.1/230-1	IOFAE222B100D0000S	21.8
i550-C1.5/230-1		
i550-C2.2/230-1		
i550-C0.37/400-3	IOFAE175F100D0000S	3.3
i550-C0.55/400-3		
i550-C0.75/400-3		
i550-C1.1/400-3	IOFAE222F100D0000S	7.3
i550-C1.5/400-3		
i550-C2.2/400-3		
i550-C3.0/400-3	IOFAE255F100D0000S	18.0
i550-C4.0/400-3		
i550-C5.5/400-3		
i550-C7.5/400-3		
i550-C11/400-3	IOFAE311F100D0000S	29.0

Inverter	Mains filters	
	Order code	Rated current A
i550-C15/400-3	E84AZESR1834LD	50.4
i550-C18/400-3		
i550-C22/400-3	E84AZESM2234LD	42.0
i550-C30/400-3	E84AZESM3034LD	55.0
i550-C37/400-3	E84AZESM3734LD	68.0
i550-C45/400-3	E84AZESM4534LD	80.0



### Sinusoidal filters

A sinusoidal filter in the motor cable limits the rate of voltage rise and the capacitive charge/discharge currents that occur during inverter operation.



Only use a sinusoidal filter with standard asynchronous motors 0 to 550 V.

Operation only with V/f or square-law V/f characteristic control.

Set the switching frequency permanently to the specified value.

Limit the output frequency of the inverter to the given value.



Inverter		Sinusoidal filters		
	Switching frequency	Order code	Rated inductance	Max. output frequency
	kHz		mH	Hz
i550-C0.37/400-3	4 8	EZS3-004A200	11.0	150
i550-C0.55/400-3				
i550-C0.75/400-3				
i550-C1.1/400-3		EZS3-010A200	5.10	
i550-C1.5/400-3				
i550-C2.2/400-3		EZS3-017A200	3.07	
i550-C3.0/400-3				
i550-C4.0/400-3		EZS3-024A200	2.50	
i550-C5.5/400-3				
i550-C7.5/400-3		EZS3-032A200	2.00	
i550-C11/400-3				
i550-C15/400-3		EZS3-037A200	1.70	
i550-C18/400-3				
i550-C22/400-3		EZS3-048A200	1.20	
		EZS3-061A200	1.00	

# Inverter

Accessories  
Power supply units



## Power supply units

For the external supply of the control electronics of the inverter.

The parameterisation and diagnostics can be executed when the mains input at the inverter is deenergised.



Order code		EZV1200-000	EZV2400-000	EZV4800-000	EZV1200-001	EZV2400-001	EZV4800-001
Rated voltage	V	230			400		
Rated mains current	A	0.8	1.2	2.3	0.3	0.6	1.0
Input voltage	V	AC 85 - 264 DC 90 ...350			AC 320 ... 575 DC 450 ...800		
Output voltage	V	DC 22.5 - 28.5					
Rated output current	A	5.0	10.0	20.0	5.0	10.0	20.0

## Brake switches

For switching an electromechanical brake.

The brake switch consists of a rectifier and an electronic circuit breaker.

It is mounted on the control cabinet plate by means of two screws. Control is performed using a digital output on the inverter.



Brake switches		Half-wave rectifiers	Bridge rectifiers
Order code		E82ZWBRE	E82ZWBRR
Input voltage	V	AC 320 - 550	AC 180 - 317
Output voltage	V	DC 180 (with AC 400) DC 225 (with AC 500)	DC 205 (with AC 230)
Max. brake current	A	0.61	0.54





## Mounting

### Shield mounting kit

If the motor shielding is implemented on an earthing busbar in the control cabinet, no shield sheet is required.

Optionally, the shield of the motor cable can be connected with the shield mounting kit, consisting of shield sheet and fixing clips or wire clamps.



From 15 kW, the shield sheet is integrated.



Inverter	Shield mounting kit			
	Order code	VPE		
		Piece		
i550-C0.25/230-1	EZAMBHXM014/M	5x motor shield sheet 10x fixing clip		
i550-C0.25/230-2				
i550-C0.37/230-1				
i550-C0.37/230-2				
i550-C0.55/230-1				
i550-C0.55/230-2				
i550-C0.75/230-1				
i550-C0.75/230-2				
i550-C1.1/230-1				
550-C1.1/230-2				
i550-C1.5/230-1				
i550-C1.5/230-2				
i550-C2.2/230-1				
i550-C2.2/230-2				
i550-C0.37/400-3				
i550-C0.55/400-3				
i550-C0.75/400-3				
i550-C1.1/400-3				
i550-C1.5/400-3				
i550-C2.2/400-3				
i550-C3.0/400-3	EZAMBHXM015/M	5x motor shield sheet 10x fixing clip		
i550-C4.0/400-3				
i550-C5.5/400-3				
i550-C7.5/400-3	EZAMBHXM016/M	5x motor shield sheet 10x wire clamp (cable diameter 10 ... 20 mm)		
i550-C11/400-3				
i550-C15/400-3	EZAMBHXM004/M	5x wire clamp (cable diameter 15 ... 28 mm)		
i550-C18.5/400-3				
i550-C22/400-3				
i550-C30/400-3			EZAMBHXM005/M	5x wire clamp (cable diameter 20 ... 37 mm)
i550-C37/400-3				
i550-C45/400-3				

# Inverter

Accessories  
Mounting



## Shield mounting for the control unit



In case of the control unit, the shield sheet is integrated.

Usually, the shields of the control cables are fixed with cable ties. Optionally, fixing clips are available.

Shield mounting kit	
Order code	VPE
	Piece
EZAMBHXM007/M	20x fixing clip

## Terminal strips

For connecting the inverter, all connections are equipped with pluggable connectors. These pluggable connectors are available separately for service purposes or if cable harnesses need to be physically separated.

Inverter	Terminal strips Mains connection X100		Terminal strips Motor connection X105	
	Order code	VPE	Order code	VPE
		Piece		Piece
i550-C0.25/230-1	EZA EVE032/M	10	EZA EVE039/M	5
i550-C0.25/230-2				
i550-C0.37/230-1				
i550-C0.37/230-2				
i550-C0.55/230-1				
i550-C0.55/230-2				
i550-C0.75/230-1				
i550-C0.75/230-2				
i550-C1.1/230-1	EZA EVE033/M	10		
i550-C1.1/230-2				
i550-C1.5/230-1				
i550-C1.5/230-2				
i550-C2.2/230-1	EZA EVE037/M	5		
i550-C2.2/230-2				
i550-C0.37/400-3				
i550-C0.55/400-3				
i550-C0.75/400-3				
i550-C1.1/400-3				
i550-C1.5/400-3				
i550-C2.2/400-3				

Terminal strips	Order code	VPE	Terminal strips	Order code	VPE
		Piece			Piece
Safety (STO) X1	EZA EVE029/M	10	Standard I/O X3	EZA EVE040/M	5
Relay X9	EZA EVE030/M	10	Application I/O X3	EZA EVE041/M	5
Motor PTC X109	EZA EVE031/M	10	CANopen / Modbus X216	EZA EVE042/M	10



## Mounting/ installation

More data and information for the mechanical and electrical installation can be found here:

- [Control cabinet structure](#) 31
- [EMC-compliant wiring](#) 32
- [Standards and operating conditions](#) 35
- [Dimensions](#) 65



The scope of supply of the inverter comprises mounting instructions. They describe technical data and information on mechanical and electrical installation.

### DANGER!

Dangerous electrical voltage

Depending on the device, all power connections may be live up to 3 minutes after switching off the supply.

Possible consequences: Death or severe injuries when touching the power terminals.

- ▶ Wait for at least 3 minutes before you start working on the power terminals.
- ▶ Make sure that all power terminals are deenergised.

### DANGER!

Dangerous electrical voltage

The leakage current against earth (PE) is  $> 3.5$  mA AC or  $> 10$  mA DC.

Possible consequences: Death or severe injuries when touching the device in the event of an error.

- ▶ Implement the measures required in EN 61800-5-1, especially:
- ▶ Fixed installation
- ▶ The PE connection must comply with the standards (PE conductor diameter  $\geq 10$  mm<sup>2</sup> or use a double PE conductor)

### NOTICE!

No device protection against too high mains voltage

The mains input is not fused internally.

Possible consequences: Destruction of the device at too high mains voltage.

- ▶ Please observe the maximum permissible mains voltage.
- ▶ Fuse the device professionally on the supply side against mains fluctuations and voltage peaks.

### DANGER!

Use of the inverter on a phase earthed mains with a rated mains voltage  $\geq 400$  V

The protection against accidental contact is not ensured without external measures.

- ▶ If protection against accidental contact according to EN 61800-5-1 is required for the control terminals of the inverters and the connections of the plugged device modules, ...
- ▶ an additional basic insulation has to be provided.
- ▶ the components to be connected have to come with a second basic insulation.

# Inverter

Mounting/ installation  
Mounting



## **i NOTICE!**

Overvoltage at devices with 230-V mains connection

An impermissible overvoltage may occur if the central supply of the N conductor is interrupted if the devices are connected to a TN three-phase system.

Possible consequences: Destruction of the device

- ▶ Provide for the use of isolating transformers.

## **i NOTICE!**

The product contains electrostatic sensitive devices.

Possible consequences: Destruction of the device

- ▶ Before working in the connection area, the staff must ensure to be free of electrostatic charge.

## **i NOTICE!**

Pluggable terminal strips or plug connections

Plugging or removing the terminal strips or plug connections during operation may cause high voltages and arcing.

Possible consequences: Damage of the devices

- ▶ Switch off device.
- ▶ Only plug or remove the terminal strips or plug connections in deenergised status.

## **i NOTICE!**

Use of mains filters and RFI filters in IT systems

Mains filters and RFI filters from Lenze contain components that are interconnected against PE.

Possible consequences: The filters may be destroyed when an earth fault occurs.

Possible consequences: Monitoring of the IT system may be triggered.

- ▶ Do not use mains filters and RFI filters from Lenze in IT systems.
- ▶ Before using the inverter in the IT system, remove the IT screws.

## **i NOTICE!**

Overvoltage at components

In case of an earth fault in IT systems, intolerable overvoltages may occur in the plant.

Possible consequences: Destruction of the device.

- ▶ Before using the inverter in the IT system, remove the contact screws. The description of the positions and number depends on the respective device and has to be observed.



Ensure a trouble-free operation:

Carry out the total wiring so that the separation of the separate potential areas is preserved.



## Inverter

Mounting/ installation  
Mounting

---



When implementing machines and systems for the use in the UL/CSA scope, you have to observe especially issued notes.

These notes and further information on the UL/CSA subject are summarised in separated documents.

---



You have to install the devices into housings (e. g. control cabinets) to comply with valid regulations.

Stickers with warning notes must be displayed prominently and close to the device.

---

# Inverter

Mounting/ installation  
Mounting



---

## Mounting position

- Vertical alignment - all mains connections are at the top and the motor connections at the bottom.

## Free spaces

- Maintain the specified free spaces above and below to the other installations.

## Mechanical installation

- The mounting location and material must ensure a durable mechanical connection.
- Do not mount onto DIN rails!
- In case of continuous vibrations or shocks use vibration dampers.

## How to mount the inverters onto the mounting plate

1. Prepare mounting plate with corresponding threaded holes and equip them with screws and, if required, washers.
  - a) Use screw and washer assemblies or hexagon socket screws with washers.
  - b) Do not yet tighten the screws.
2. Mount the inverter on the prepared mounting plate via keyhole suspension.
3. Only tighten the screws hand-tight.
4. If required, pre-assemble further units.
5. Adjust the units.
6. Screw the units onto the mounting plate.

*The inverters are ready for wiring.*

Screw and washer assemblies or hexagon socket screws with washers are recommended..

M5 x  $\geq$  10 mm for devices up to and including 2.2 kW

M5 x  $\geq$  12 mm for devices up to and including 11 kW

M6 x  $\geq$  16 mm for devices up to and including 22 kW

M8 x  $\geq$  16 mm for devices up to and including 45 kW

## Measures for cooling during operation

- Ensure unimpeded ventilation of cooling air and outlet of exhaust air.
- If the cooling air is polluted (fluff, (conductive) dust, soot, aggressive gases), take adequate countermeasures.
  - Install filters.
  - Arrange for regular cleaning of the filters.
- If required, implement a separate air guide.



### Detecting and eliminating EMC interferences

Trouble	Cause	Remedy
Interferences of analog setpoints of your own or other devices and measuring systems	Unshielded motor cable has been used	Use shielded motor cable
	Shield contact is not extensive enough	Carry out optimal shielding as specified
	Shield of the motor cable is interrupted, e. g. by terminal strips, switches etc.	<ul style="list-style-type: none"> <li>Separate components from other component parts with a minimum distance of 100 mm</li> <li>Use motor chokes or motor filters</li> </ul>
	Additional unshielded cables inside the motor cable have been installed, e. g. for motor temperature monitoring	Install and shield additional cables separately
	Too long and unshielded cable ends of the motor cable	Shorten unshielded cable ends to maximally 40 mm
Conducted interference level is exceeded on the supply side	Terminal strips for the motor cable are directly located next to the mains terminals	Spatially separate the terminal strips for the motor cable from mains terminals and other control terminals with a minimum distance of 100 mm
	Mounting plate varnished	Optimise PE connection: <ul style="list-style-type: none"> <li>Remove varnish</li> <li>Use zinc-coated mounting plate</li> </ul>
	HF short circuit	Check cable routing

A good shield connection at the transitions of the different areas reduce possible interferences caused by problems with the EMC.

#### Example of an EMC-compliant cable gland

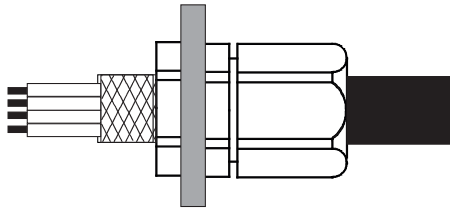

*Fig. 5: EMC cable gland with a high degree of protection*

# Inverter

Mounting/ installation  
Mains connection



---

## Mains connection

The following should be considered for the mains connection of inverters:

Single inverters are either directly connected to the **AC system** or via upstream filters. RFI filters are already integrated in many inverters. Depending on the requirements, mains chokes or mains filters can be used.

Inverter groups are connected to the **DC system** with the DC bus. For this purpose, the inverters have to be provided with a connection for the DC bus, e. g. terminals +UG/-UG.

This enables the energy exchange in phases with operation in generator and motor mode of several drives in the network.

The DC system can be provided by power supply modules (AC/DC converters) or inverters with a power reserve.

The technical data informs about the possible applications in the given groups. In the dimensioning, data and further notes have to be observed.





# Inverter

Mounting/ installation  
Mains connection

## 1-phase mains connection 230 V

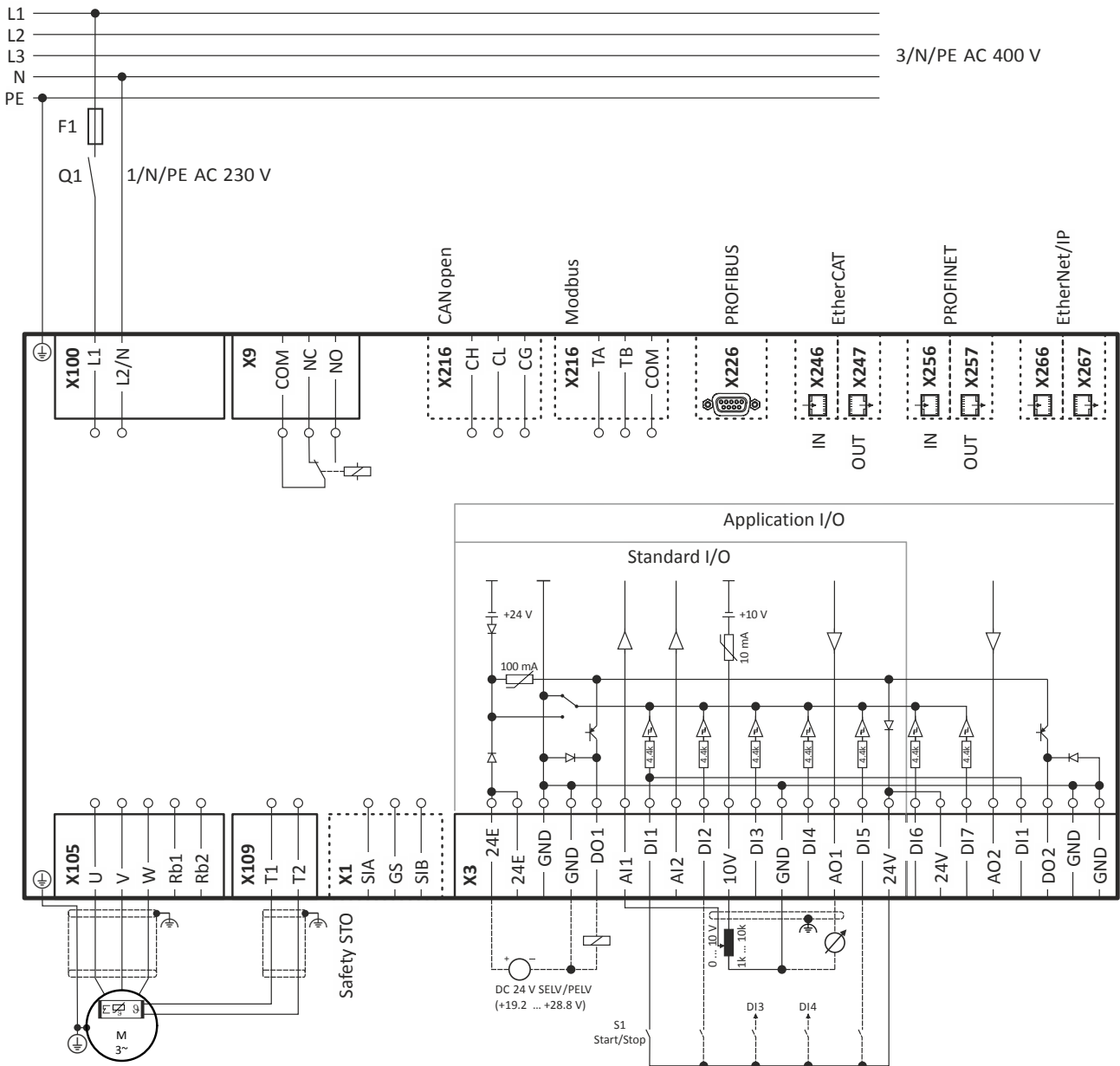

Fig. 6: Wiring example

S1 Start/stop

--- Dashed line = options

# Inverter

Mounting/ installation  
Mains connection



## 1/3-phase mains connection 230/240 V

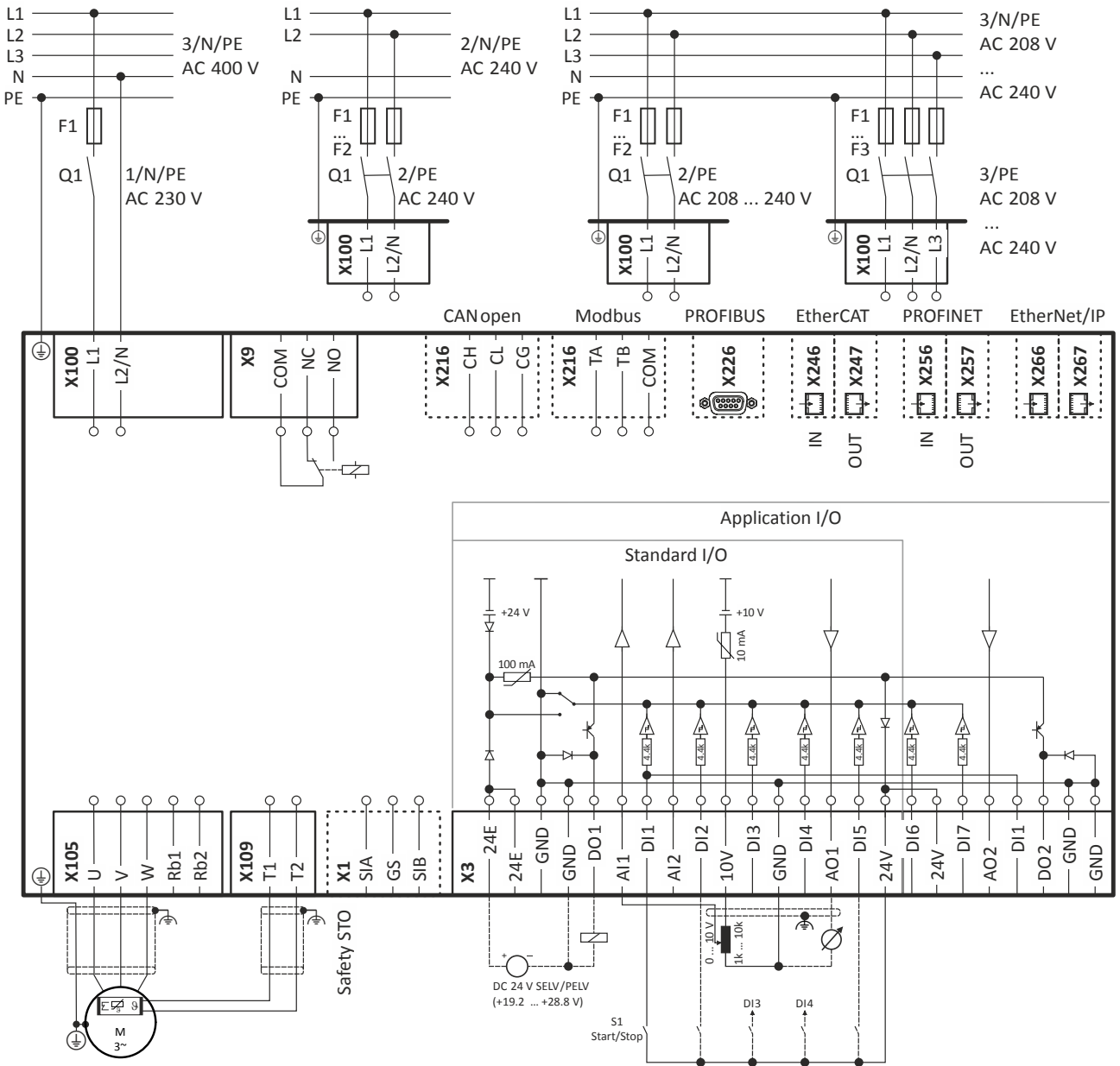

Fig. 7: Wiring example

S1 Start/stop

--- Dashed line = options



# Inverter

Mounting/ installation  
Mains connection

## 3-phase mains connection 400 V

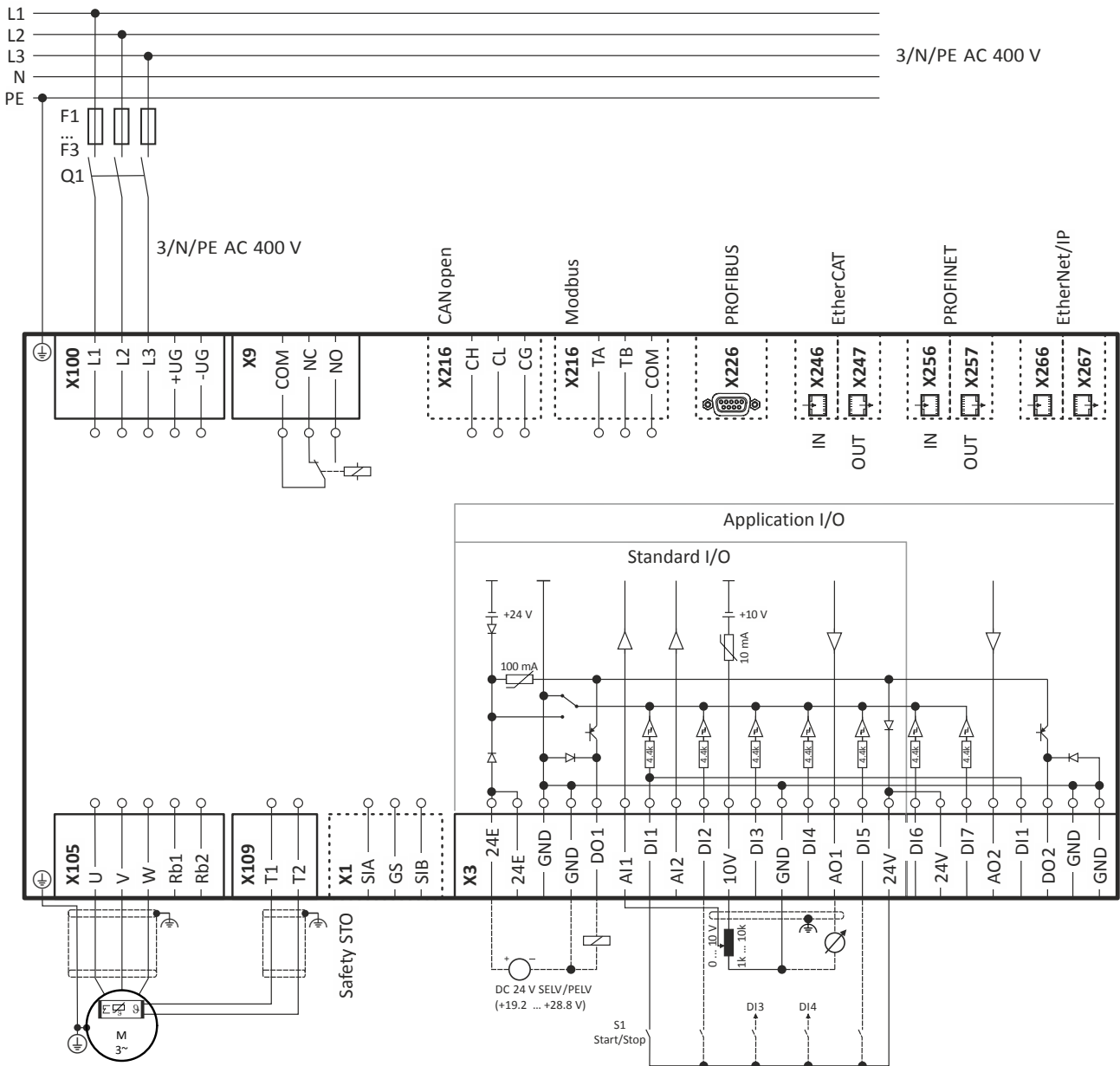

Fig. 8: Wiring example

S1 Start/stop

--- Dashed line = options

# Inverter

Mounting/ installation  
Mains connection



## 3-phase mains connection 480 V

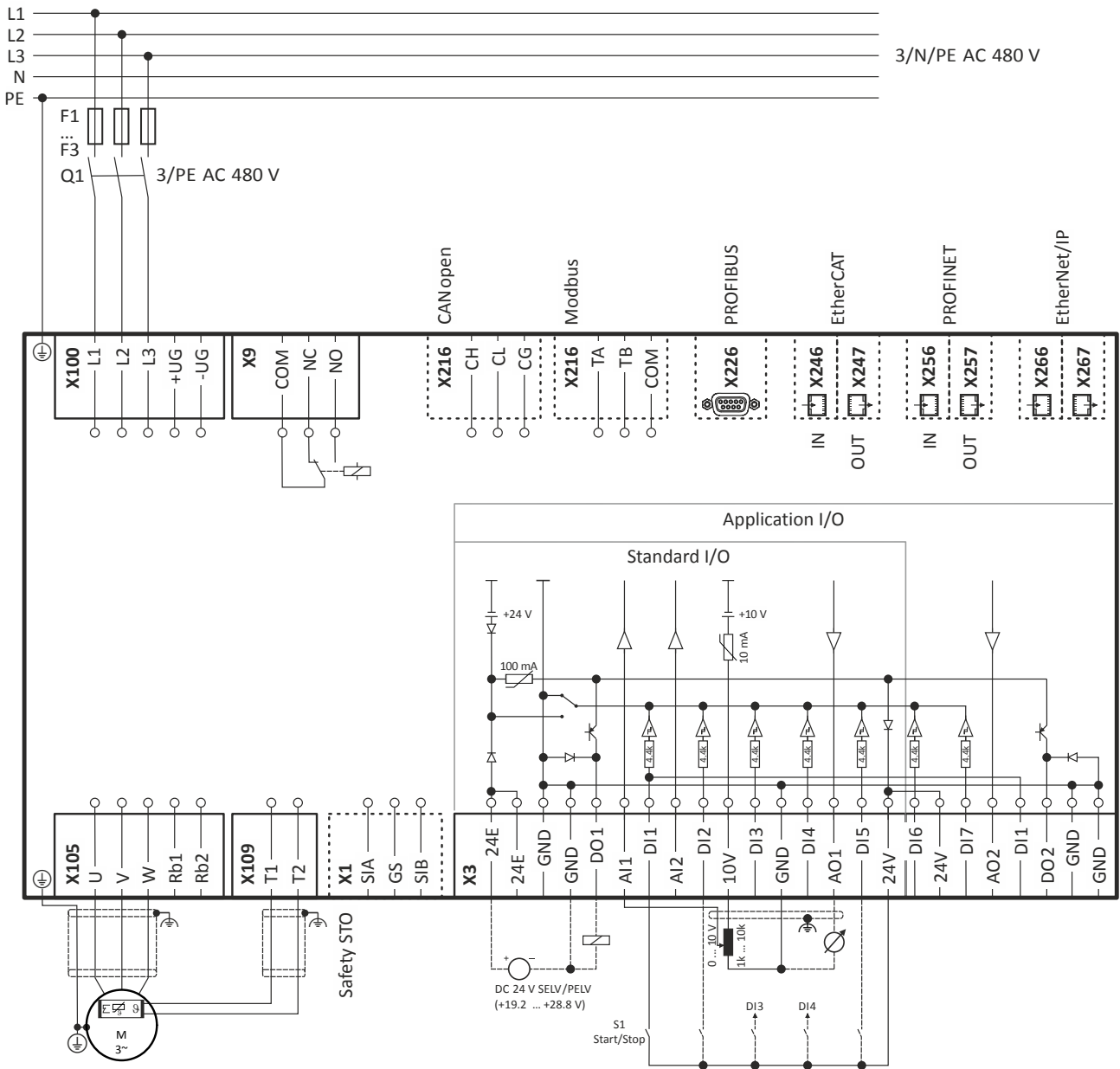

Fig. 9: Wiring example

S1 Start/Stop

--- Shown by dashed lines = options



## Motor connection

A good shield connection and short cable lengths reduce possible interferences caused by problems with the EMC.

### Example for preparing the EMC-compliant wiring or the motor cable

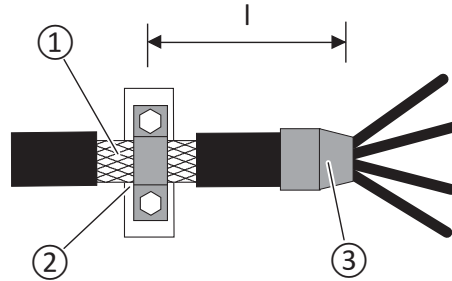

Fig. 10: Shield connection

- |   |                        |
|---|------------------------|
| ① Braid                                 | ③ Heat-shrinkable tube |
| ② large surface contacting of the braid | l maximally 500 mm     |

## Switching in the motor cable



Switching on the motor side of the inverter is permissible:

For safety shutdown (emergency stop).

In case several motors are driven by one inverter (only in V/f operating mode).

Please note the following:

The switching elements on the motor side must be dimensioned for with the maximum occurring load.

## Connection of motor temperature monitoring



If the terminal X109 is used, e. g. to connect an external PTC thermistor (PTC) or a thermal contact, ensure at least one basic insulation to the potentials of motor, mains and control terminals to not restrict the protective separation of the control terminals.

# Inverter

Mounting/ installation  
Brake resistor connection



## Brake resistor connection

If wiring of the brake resistor can be kept short, it is sufficient to twist the cables. Up to 0.5 m of cable length, this applies to the cable of the brake resistor and the cable of temperature monitoring. This procedure reduces interferences caused by problems with the EMC.

### Cables for a brake resistor - short version

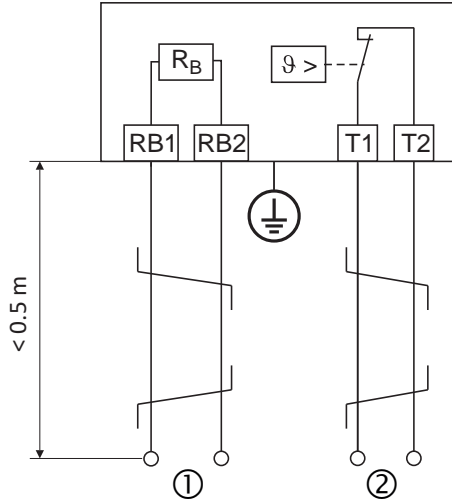

Fig. 11: Connection plan - brake resistor with a cable length of up to 0.5 m

- ① For the connection of the "brake resistor" to the inverter or another component with brake chopper
- ② For a control contact, e.g. digital input that is set to the monitoring mode of the thermal contact

If wiring of the brake resistor cannot be kept short, a shielded cable is required. The cable of the brake resistor shall not exceed a length of 5 m.

For the cable of temperature monitoring, twisting is sufficient. This procedure reduces interferences caused by problems with the EMC.

### Cables for a brake resistor - long version

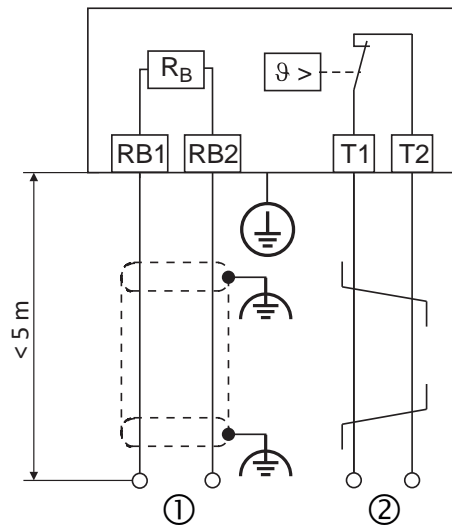

Fig. 12: Connection plan - brake resistor with a cable length of up to 5 m

- ① For the connection of the "brake resistor" to the inverter or another component with brake chopper
- ② For a control contact, e.g. digital input that is set to the monitoring mode of the thermal contact



---

### Control connections



In order to achieve an optimum shielding effect (in case of very long cables, with high interference), one shield end of analog input and output cables can be connected to PE potential via a capacitor (e. g. 10 nF/250 V).

---

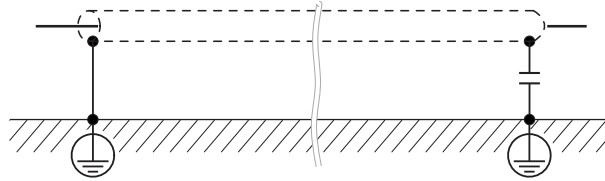

# Inverter

Purchase order  
Notes on ordering





## Purchase order

### Notes on ordering

There are two ways to order an inverter.

As a complete inverter or as single components consisting of power unit, control unit and safety module.

Complete inverter	Inverter consisting of components
	 <p>Power unit</p> <p>Control unit</p> <p>Safety module</p>





---

**Order code**

**Delivery as complete inverter**

If always the same inverter is used in the machine the inverter can be ordered "out of the box".

Order data: Order code of the complete device.

**Order example**

Selection	Order code
3-phase mains connection 400 V	i55AE222F1A010002S
Power 2.2 kW (i550-C2.2/400-3)	
Safety function STO	
Global - type 50 Hz/metric	
Standard I/O with CANopen	

# Inverter

Purchase order  
Order code



Power		Inverter	Order code				
kW	hp						
1-phase mains connection 230 V							
0.25	0.33	i550-C0.25/230-1	i55AE125B1				
0.37	0.5	i550-C0.37/230-1	i55AE137B1				
0.55	0.75	i550-C0.55/230-1	i55AE155B1				
0.75	1	i550-C0.75/230-1	i55AE175B1				
1.1	1.5	i550-C1.1/230-1	i55AE211B1				
1.5	2	i550-C1.5/230-1	i55AE215B1				
2.2	3	i550-C2.2/230-1	i55AE222B1				
1/3-phase mains connection 230/240 V							
0.25	0.33	i550-C0.25/230-2	i55AE125D1				
0.37	0.5	i550-C0.37/230-2	i55AE137D1				
0.55	0.75	i550-C0.55/230-2	i55AE155D1				
0.75	1	i550-C0.75/230-2	i55AE175D1				
1.1	1.5	i550-C1.1/230-2	i55AE211D1				
1.5	2	i550-C1.5/230-2	i55AE215D1				
2.2	3	i550-C2.2/230-2	i55AE222D1				
3-phase mains connection 400/480 V							
0.37	0.5	i550-C0.37/400-3	i55AE137F1		01		
0.55	0.75	i550-C0.55/400-3	i55AE155F1				
0.75	1	i550-C0.75/400-3	i55AE175F1				
1.1	1.5	i550-C1.1/400-3	i55AE211F1				
1.5	2	i550-C1.5/400-3	i55AE215F1				
2.2	3	i550-C2.2/400-3	i55AE222F1				
3	4	i550-C3/400-3	i55AE230F1				
4	5	i550-C4/400-3	i55AE240F1				
5.5	7.5	i550-C5.5/400-3	i55AE255F1				
7.5	10	i550-C7.5/400-3	i55AE275F1				
11	15	i550-C11/400-3	i55AE311F1				
15	20	i550-C15/400-3	i55AE315F1				
18.5	25	i550-C18.5/400-3	i55AE318F1				
22	30	i550-C22/400-3	i55AE322F1				
30	40	i550-C30/400-3	i55AE330F1				
37	50	i550-C37/400-3	i55AE337F1				
45	60	i550-C45/400-3	i55AE345F1				
Safety engineering							
Without safety engineering					0		
Safety function STO					A		
Control code							
Global - type 50 Hz/metric						0	
Local - type 60 Hz/Imperial						1	
Control unit type							
Standard I/O without network							000S
Application I/O without network							001S
Standard I/O with CANopen							002S
Standard I/O with Modbus							003S
Standard I/O with PROFIBUS							004S
Standard I/O with EtherCAT							00KS
Standard I/O with PROFINET							00LS
Standard I/O with EtherNet/IP							00MS

## Delivery of individual components

If different product versions are required in the machine, the various components can be ordered individually. Depending on the application, the components can be plugged together easily without any further tools.



Order data: Order codes of the individual components.

**Order example**

Selection	Order code
3-phase mains connection 400/480 V Power 2.2 kW (i550-C2.2/400-3)	I5DAE222F10010000S
Safety function STO	I5MASA00000000S
Control unit (type 50 Hz) Standard I/O with CANopen	I5CA5C020000A0000S

Power unit			Order code
Power		Inverter	
kW	HP		
1-phase mains connection 230 V			
0.25	0.33	i550-C0.25/230-1	I5DAE125B10010000S
0.37	0.5	i550-C0.37/230-1	I5DAE137B10010000S
0.55	0.75	i550-C0.55/230-1	I5DAE155B10010000S
0.75	1	i550-C0.75/230-1	I5DAE175B10010000S
1.1	1.5	i550-C1.1/230-1	I5DAE211B10010000S
1.5	2	i550-C1.5/230-1	I5DAE215B10010000S
2.2	3	i550-C2.2/230-1	I5DAE222B10010000S
1/3-phase mains connection 230/240 V			
0.25	0.33	i550-C0.25/230-2	I5DAE125D10010000S
0.37	0.5	i550-C0.37/230-2	I5DAE137D10010000S
0.55	0.75	i550-C0.55/230-2	I5DAE155D10010000S
0.75	1	i550-C0.75/230-2	I5DAE175D10010000S
1.1	1.5	i550-C1.1/230-2	I5DAE211D10010000S
1.5	2	i550-C1.5/230-2	I5DAE215D10010000S
2.2	3	i550-C2.2/230-2	I5DAE222D10010000S
3-phase mains connection 400/480 V			
0.37	0.5	i550-C0.37/400-3	I5DAE137F10010000S
0.55	0.75	i550-C0.55/400-3	I5DAE155F10010000S
0.75	1	i550-C0.75/400-3	I5DAE175F10010000S
1.1	1.5	i550-C1.1/400-3	I5DAE211F10010000S
1.5	2	i550-C1.5/400-3	I5DAE215F10010000S
2.2	3	i550-C2.2/400-3	I5DAE222F10010000S
3	4	i550-C3/400-3	I5DAE230F10010000S
4	5	i550-C4/400-3	I5DAE240F10010000S
5.5	7.5	i550-C5.5/400-3	I5DAE255F10010000S
7.5	10	i550-C7.5/400-3	I5DAE275F10010000S
11	15	i550-C11/400-3	I5DAE311F10010000S
15	20	i550-C15/400-3	I5DAE315F10010000S
18.5	25	i550-C18.5/400-3	I5DAE318F10010000S
22	30	i550-C22/400-3	I5DAE322F10010000S
30	40	i550-C30/400-3	I5DAE330F10010000S
37	50	i550-C37/400-3	I5DAE337F10010000S
45	60	i550-C45/400-3	I5DAE345F10010000S

Safety module	Order code
Safety function STO	I5MASA00000000S

# Inverter

Purchase order  
Order code



Control unit	Order code	
	Type 50 Hz	Type 60 Hz
Standard I/O without network	I5CA50020000A0000S	I5CA50020000A1000S
Application I/O without network	I5CA50030000A0000S	I5CA50030000A1000S
Standard I/O with CANopen	I5CA5C020000A0000S	I5CA5C020000A1000S
Standard I/O with Modbus	I5CA5W020000A0000S	I5CA5W020000A1000S
Standard I/O with PROFIBUS	I5CA5P020000A0000S	I5CA5P020000A1000S
Standard I/O with EtherCAT	I5CA5T020000A0000S	I5CA5T020000A1000S
Standard I/O with PROFINET	I5CA5R020000A0000S	I5CA5R020000A1000S
Standard I/O with EtherNet/IP	I5CA5G020000A0000S	I5CA5G020000A1000S



## Appendix

### Good to know

#### Approvals/directives

CCC	China Compulsory Certification documents the compliance with the legal product safety requirements of the PR of China - GB standards.
c <sub>CSA</sub> <sub>US</sub>	CSA certificate, tested according to US and Canada standards
CE	Communauté Européenne documents the declaration of the manufacturer that EC Directives are complied with.
CEL	China Energy Label documents the compliance with the legal energy efficiency requirements for motors, tested according to PR of China standards
CSA	Canadian Standards Association CSA certificate, tested according to Canada standards
UL <sup>Energy</sup> <sub>US CA</sub>	Energy Verified Certificate Determining the energy efficiency according to CSA C390 for products within the scope of energy efficiency requirements in the USA and Canada
c <sub>UL</sub> <sub>US</sub>	UL certificate for products, tested according to US and Canada standards
c <sub>UR</sub> <sub>US</sub>	UL certificate for components, tested according to US and Canada standards
EAC	Customs union Russia / Belarus / Kazakhstan certificate documents the declaration of the manufacturer that the specifications for the Eurasian conformity (EAC) required for placing electronic and electromechanical products on the market of the entire territory of the Customs Union (Russia, Belarus, Kazakhstan) are complied with.
UL	Underwriters Laboratory Listed Product
UR	UL certificate for components, tested according to US standards

# Appendix

Good to know  
Operating modes of the motor



## Operating modes of the motor

Operating modes S1 ... S10 as specified by EN 60034-1 describe the basic stress of an electrical machine.

In continuous operation a motor reaches its permissible temperature limit if it outputs the rated power dimensioned for continuous operation. However, if the motor is only subjected to load for a short time, the power output by the motor may be greater without the motor reaching its permissible temperature limit. This behaviour is referred to as overload capacity.

Depending on the duration of the load and the resulting temperature rise, the required motor can be selected reduced by the overload capacity.

### The most important operating modes

Continuous operation S1	Short-time operation S2
<p>Operation with a constant load until the motor reaches the thermal steady state. The motor may be actuated continuously with its rated power.</p>	<p>Operation with constant load; however, the motor does not reach the thermal steady state. During the following standstill, the motor winding cools down to the ambient temperature again. The increase in power depends on the load duration.</p>
Intermittent operation S3	Non-intermittent periodic operation S6
<p>Sequence of identical duty cycles comprising operation with a constant load and subsequent standstill. Start-up and braking processes do not have an impact on the winding temperature. The steady-state is not reached. The guide values apply to a cycle duration of 10 minutes. The power increase depends on the cycle duration and on the load period/downtime ratio.</p>	<p>Sequence of identical duty cycles comprising operation with a constant load and subsequent no-load operation. The motor cools down during the no-load phase. Start-up and braking processes do not have an impact on the winding temperature. The steady-state is not reached. The guide values apply to a cycle duration of 10 minutes. The power increase depends on the cycle duration and on the load period/idle time ratio.</p>

P Power  
t Time  
 $t_L$  Idle time  
 $\vartheta$  Temperature

$P_V$  Power loss  
 $t_B$  Load period  
 $t_S$  Cycle duration



## Motor control types

The inverter provides various motor control types.

### Linear V/f characteristic control

The output voltage is increased proportionately to the output frequency.

In case of low output frequencies, the motor voltage can be increased to ensure a minimum current for the breakaway torque. In the field weakening range, the output voltage of the inverter is constant (mains voltage) and the frequency can be further increased depending on the load. The maximum torque of the motor is reduced squared to the frequency increase. the maximum output power of the motor being constant.

Application areas are for instance: Single drives with constant load.

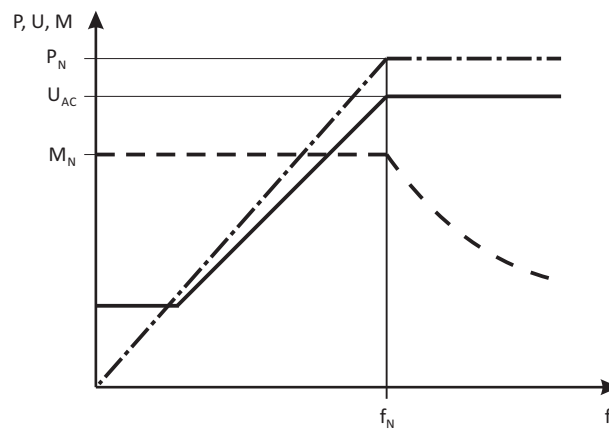

P Power  
V Voltage  
M Torque  
f Frequency

$M_{rated}$  Rated torque  
 $f_{rated}$  Rated frequency  
 $M_{rated}$  Rated torque  
 $f_{rated}$  Rated frequency



### Square-law V/f characteristic control

The output voltage is increased squared to the output frequency.

In case of low output frequencies, the motor voltage can be increased to ensure a minimum current for the breakaway torque. In the field weakening range, the output voltage of the inverter is constant (mains voltage) and the frequency can be further increased depending on the load. The maximum torque of the motor is reduced squared to the frequency increase. the maximum output power of the motor being constant.

Application areas are for instance:

- Pumps
- Fans
- Fan

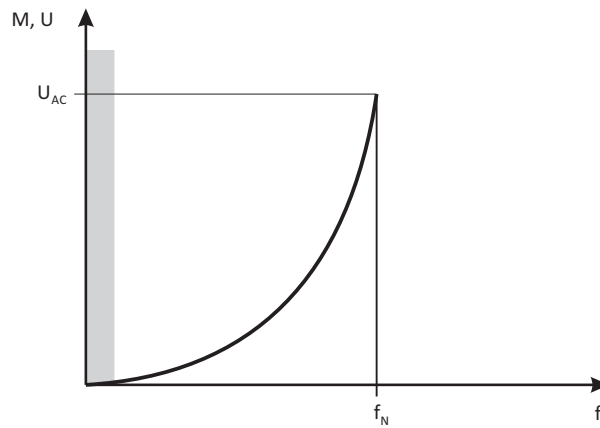

V Voltage  
f Frequency  
M Torque

$U_{AC}$  Mains voltage  
 $f_{rated}$  Rated frequency





**VFCeco**

The VFCeco mode has a special effect in the partial load operational range. Usually, three-phase AC motors are supplied there with a higher magnetising current than required by the operating conditions. The VFCeco mode reduces the losses in the partial load operational range so that savings up to 30 % are possible.

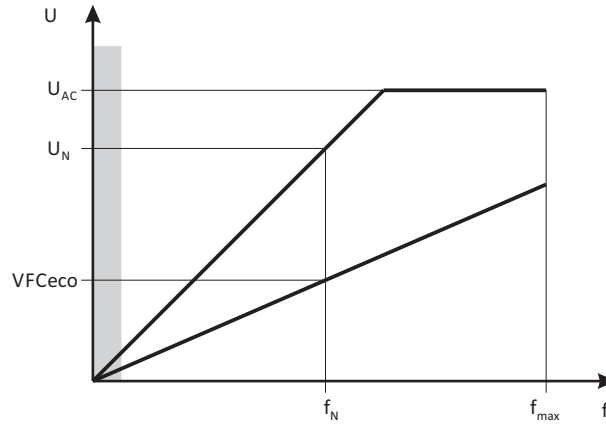

V	Voltage	f	Frequency
$U_{AC}$	Mains voltage	$f_{rated}$	Rated frequency
$U_{rated}$	Rated voltage	$f_{max}$	Max. frequency



**Sensorless vector control (SLVC)**

In vector control, an inverted voltage model is used for calculation. The parameters are detected via a parameter identification. The inverter determines the angle between current and voltage. This imposes a current on the motor”.

Compared to the V/f characteristic control, the vector control serves to achieve improved drive characteristics thanks to:

- higher torque throughout the entire speed range
- higher speed accuracy and higher concentricity factor
- higher efficiency

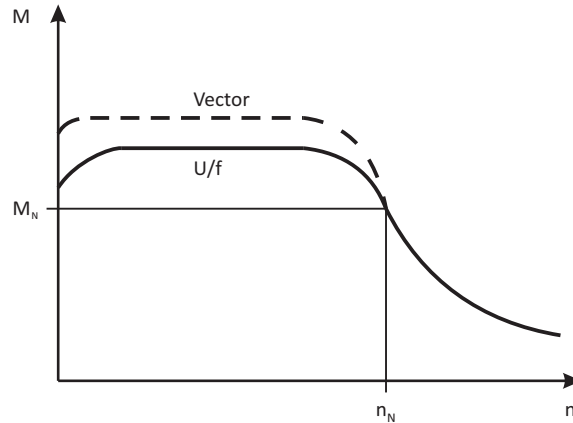

M Torque M<sub>rated</sub> Rated torque  
 n Speed n<sub>rated</sub> Rated speed

Application areas are for instance:

- Single drives with changing loads
- Single drives with high starting duty
- Sensorless speed control of three-phase AC motors

**Switching frequencies**

On an inverter, the term "switching frequency" is understood to mean the frequency with which the input and outputs of the output module (inverter) are switched. On an inverter, the switching frequency can generally be set to values between 2 and 16 kHz, whereby the selection is based on the respective power output

As switching the modules cause heat losses, the inverter can provide higher output currents at low switching frequencies than at high frequencies. Additionally, it is distinguished between the operation at a permanently set switching frequency and a variably set switching frequency. Here, the switching frequency is automatically reduced as a function of the output current.

At a higher switching frequency, the noise generation is less.

Features	Versions
Switching frequencies	<ul style="list-style-type: none"> <li>• 2 kHz</li> <li>• 4 kHz</li> <li>• 8 kHz</li> <li>• 16 kHz</li> <li>• variable (automatic adjustment)</li> </ul>



## Enclosures

The degree of protection indicates the suitability of a motor for specific ambient conditions with regard to humidity as well as the protection against contact and the ingress of foreign particles. The degrees of protection are classified by EN 60529.

The first code number after the code letters IP indicates the protection against the ingress of foreign particles and dust. The second code number refers to the protection against the ingress of humidity.

Code number 1	Degree of protection	Code number 2	Degree of protection
0	No protection	0	No protection
1	Protection against the ingress of foreign particles $d > 50$ mm. No protection in case of deliberate access.	1	Protection against vertically dripping water (dripping water).
2	Protection against medium-sized foreign particles, $d > 12$ mm, keeping away fingers or similar.	2	Protection against diagonally falling water (dripping water), $15^\circ$ compared to normal service position.
3	Protection against small foreign particles $d > 2.5$ mm. Keeping away tools, wires or similar.	3	Protection against spraying water, up to $60^\circ$ to the vertical
4	Protection against granular foreign particles, $d > 1$ mm, keeping away tools, wire or similar.	4	Protection against spraying water from all directions.
5	Protection against dust deposits (dust-protected), complete protection against contact.	5	Protection against water jets from all directions.
6	Protection against the ingress of dust (dust-proof), complete protection against contact.	6	Protection against choppy seas or heavy water jets (flood protection).

🏢 Lenze Drives GmbH  
Postfach 10 13 52, D-31763 Hameln  
Breslauer Straße 3, D-32699 Extertal  
Germany  
HR Lemgo B 6478  
☎ +49 5154 82-0  
📠 +49 5154 82-2800  
@ lenze@lenze.com  
🌐 www.lenze.com

✂ Lenze Service GmbH  
Breslauer Straße 3, D-32699 Extertal  
Germany  
☎ 0080002446877 (24 h helpline)  
📠 +49 5154 82-1112  
@ service.de@lenze.com

TD 20151204