

KRT18BM

Multicolor contrast sensor

en 01-2016/06 50133231

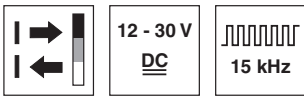

13mm

- Easy to adjust through display of the signal strength on the device
- Simple sensitivity adjustment with multiturn potentiometer
- RGB transmitter with selectable detection color
- Removable rotary operating knob enables comfortable, tool-free adjustment
- Maximum packing quality through short response time
- Remote control via control cable
- Blocking of all operational controls via control cable
- Analog output for signal evaluations in the control

We reserve the right to make changes • DS_KRT18BM_2_en_50133231.fm



Accessories:

(available separately)

- Mounting systems (BTU 200M..., BT 95)
- Mounting adapter for standard design (80 mm x 53 mm x 30 mm) BTX 018M
- Cable with M12 connector (K-D M12...)

Dimensioned drawing

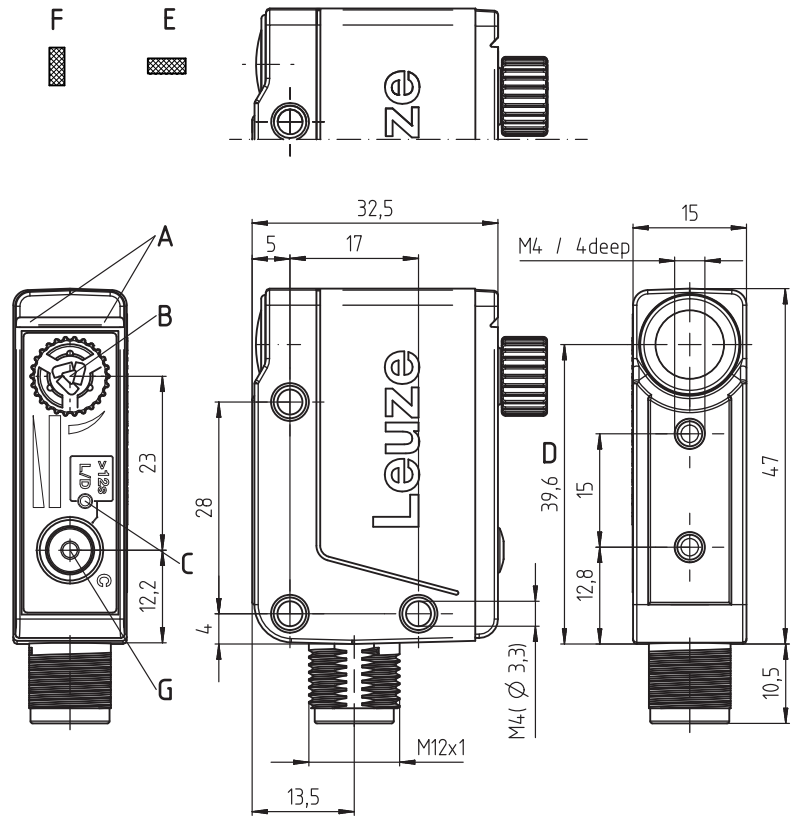

- A** Indicator diodes
- B** Knurled knob for sensitivity adjustment (removable)
- C** Display of the special functions
- D** Optical axis
- E** Horizontal light spot orientation (transverse)
- F** Light spot orientation vertical (lengthwise)
- G** Toggle switch for detection color

Electrical connection

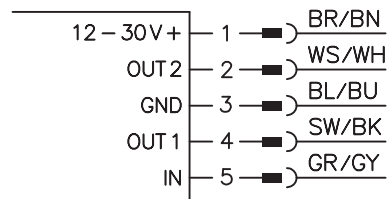

Technical data

Optical data

Scanning range	13mm ± 3mm
Light source ¹⁾	LEDs (red, green, blue)
Light spot dimensions	1mm x 4mm (at a distance of 13 mm)
Light spot orientation	vertical (lengthwise) or horizontal (transverse)

Timing

Switching frequency	switching outputs: 15kHz
Response time	switching outputs: 33µs analog output: 100µs
Readiness delay	< 300ms

Electrical data

Operating voltage U_B ²⁾	12 ... 30VDC (incl. residual ripple)
Residual ripple	≤ 15% of U_B
Open-circuit current	25mA (at 24V)
Switching outputs/functions	OUT1 push-pull, PNP dark switching (dark on), NPN light switching (light on), changeover-capable
Only KRT18B.../G6T...:	OUT2 push-pull, PNP light switching (light on), NPN dark switching (dark on), changeover-capable
Signal voltage high/low	≥ ($U_B - 2V$) / ≤ 2V
Output current	max. 100mA
Input	IN configuration input and blocking of the operational controls
Analog output	OUT2 middle position of analog range for white target (90% rem.)
KRT18B.../GCT...:	current: 4 ... 20mA, R_L ≤ 500Ohm
KRT18B.../GC1T...:	current: 0.3 ... 10mA, R_L ≤ 500Ohm
KRT18B.../GV1T...:	voltage: 0 ... 5V, R_L ≥ 2kOhm

Indicators

Green LED continuous light	ready
Yellow LED continuous light	switching signal - dark switching (dark on)
Bar graph	reception signal strength, 13-level
Yellow LEDs - special functions	light/dark switching

Mechanical data

Housing	diecast zinc, chemically nickel-plated
Connector	diecast zinc, chemically nickel-plated
Optics	PMMA
Operation	multiturn potentiometer for sensitivity adjustment, button for changing the detection color (C)
Weight	60g
Connection type	M12 connector, 5-pin

Environmental data

Ambient temp. (operation/storage)	-40°C ... +60°C / -40°C ... +70°C
Protective circuit ³⁾	2, 3
VDE safety class ⁴⁾	III
Degree of protection	IP67, IP 69K
Light source	exempt group (in acc. with EN 62471)
Standards applied	IEC 60947-5-2
Certifications	UL 508, C22.2 No.14-13 ^{2) 5)}
Chemical resistance	tested in accordance with ECOLAB

Additional functions

Full control of the application	13-level bar graph signal display on the device
Light/dark switching (L/D)	can be activated via control button
Change of detection color	can be activated via control button

- 1) Average life expectancy 100,000h at an ambient temperature of 25°C
- 2) For UL applications: use is permitted exclusively in Class 2 circuits according to NEC
- 3) 2=polarity reversal protection, 3=short circuit protection for all transistor outputs
- 4) Rating voltage 50V
- 5) These proximity switches shall be used with UL Listed Cable assemblies rated 30V, 0.24A min, in the field installation, or equivalent (categories: CYJV/CYJV7 or PVVA/PVVA7)

Notes

Observe intended use!

- ☞ This product is not a safety sensor and is not intended as personnel protection.
- ☞ The product may only be put into operation by competent persons.
- ☞ Only use the product in accordance with its intended use.

- **Glossy objects:**
With glossy objects, the sensor is to be fastened at an inclination of approx. 10° ... 15° relative to the object surface.

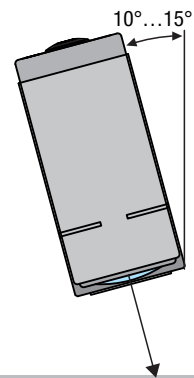

- **Alignment aid:**
An alignment aid is included in the scope of delivery of each sensor. This facilitates simple alignment of the sensor to the working distance of 13 mm without needing to perform electrical commissioning.

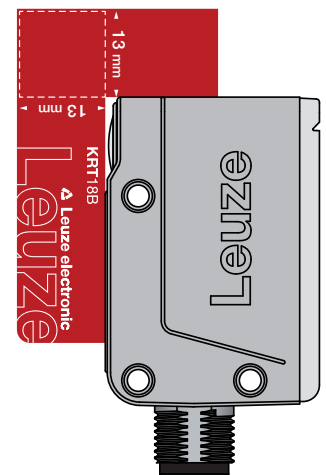

KRT18BM

Multicolor contrast sensor

Part number code

K	R	T	1	8	B	M	.	H	2	/	G	6	T	-	M	1	2
---	---	---	---	---	---	---	---	---	---	---	---	---	---	---	---	---	---

Operating principle

KRT Contrast sensor

Series

18B 18B series

Light source

M Multicolor RGB

Light spot orientation

H Horizontal (transverse)

V Vertical (lengthwise)

Setting

2 Multiturn potentiometer with bar graph signal display, RGB changeover via button

Pin assignment of connector pin 4 / black cable wire (OUT1)

G Push-pull switching output, PNP dark switching (dark on), NPN light switching (light on)

Pin assignment of connector pin 2 / white cable wire (OUT2)

6 Push-pull switching output, PNP light switching (light on), NPN dark switching (dark on)

C Analog current output 4 ... 20 mA

C1 Analog current output 0.3 ... 10 mA

V1 Analog voltage output 0 ... 5V

Pin assignment of connector pin 5 / gray cable wire (IN)

T Input for changing the detection color, light/dark switching and locking of the operational controls

Connection technology

M12 M12 connector, 5-pin

Order guide

The sensors listed here are preferred types; current information at www.leuze.com

Order code	Part no.	Features
KRT18BM.V2/G6T-M12	50131246	Light spot orientation vertical (lengthwise), antivalent push-pull outputs Selectable additional function: light/dark switching
KRT18BM.H2/G6T-M12	50131247	Light spot orientation horizontal (transverse), antivalent push-pull outputs Selectable additional function: light/dark switching
KRT18BM.V2/GCT-M12	50132572	Light spot orientation vertical (lengthwise), analog output (4 ... 20mA) Selectable additional function: light/dark switching
KRT18BM.H2/GCT-M12	50132612	Light spot orientation horizontal (transverse), analog output (4 ... 20mA) Selectable additional function: light/dark switching
KRT18BM.V2/GC1T-M12	50132613	Light spot orientation vertical (lengthwise), analog output (0.3 ... 10mA) Selectable additional function: light/dark switching
KRT18BM.V2/GV1T-M12	50132614	Light spot orientation vertical (lengthwise), analog output (0 ... 5mA) Selectable additional function: light/dark switching
Accessories		
BTX 018M	50133412	Mounting adapter for mounting on mounting devices for sensors in the standard design (80 mm x 53 mm x 30 mm)

Mounting adapter BTX 018M

With the help of mounting adapter BTX 018M (part no. 50133412), contrast sensors KRT18B... can be mounted on existing mounting devices for contrast sensors in the standard design (80mm x 53mm x 30mm).

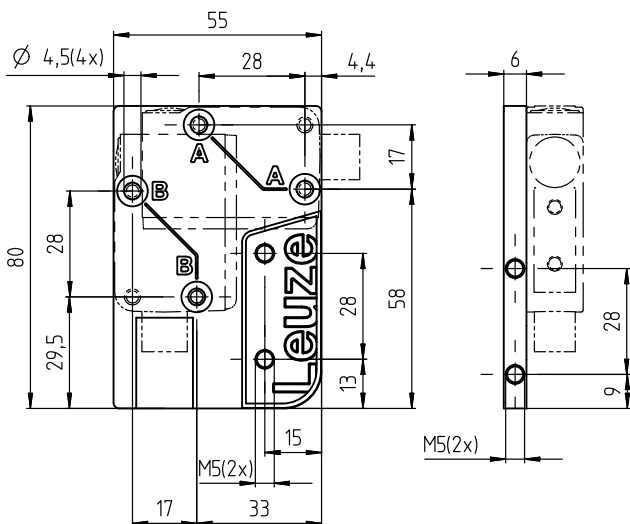

Adjusting the switching threshold

The sensitivity of contrast sensor KRT18B is set via the multiturn potentiometer.

Turning the spindle **clockwise increases the sensitivity** of the sensor. The signal on the bar graph is increased.

Turning the spindle **counterclockwise reduces the sensitivity** of the sensor. The signal on the bar graph is reduced.

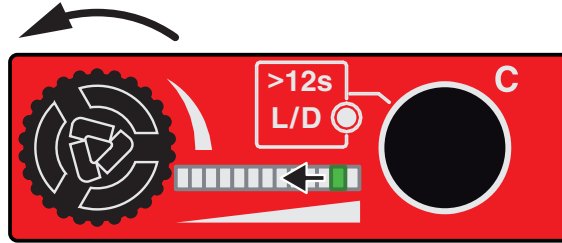
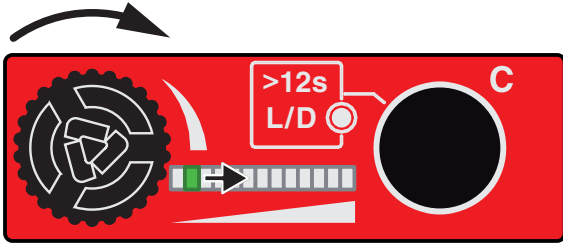

Adjustment procedure

The description is provided using the example of a dark mark on a light background. For the case of a light mark on a dark background, the terms mark and background simply need to be exchanged.

1. Positioning the background under the light spot.

If the bar graph indicator is to the left of the middle position, turn the multiturn potentiometer clockwise until the sensor switches off (yellow indicator LED **Q1** off). Several full turns may be necessary here.

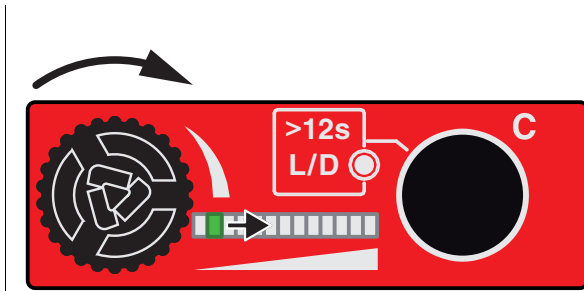

LED Q1 off:



2. Positioning the mark under the light spot.

If the bar graph indicator is to the right of the middle position, turn the multiturn potentiometer counterclockwise until the sensor switches on (yellow indicator LED **Q1** on). Several full turns may be necessary here.

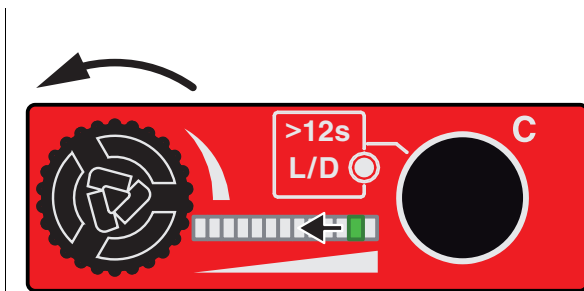

LED Q1 on:



3. Switch between mark and background and watch the bar graph while doing so. Turn the multiturn potentiometer until the deflection between the mark and the background is symmetric about the middle of the bar graph.

4. If you are not able to find a setting that enables reliable detection, repeat the process with a different detection color.

Multiturn potentiometer

A removable operating button is plugged into the multiturn potentiometer at the factory. The setting of the contrast sensor can thereby be performed manually without the need for a tool. If this is not desired, the operating button can be pulled off. A screwdriver is then needed for the setting.

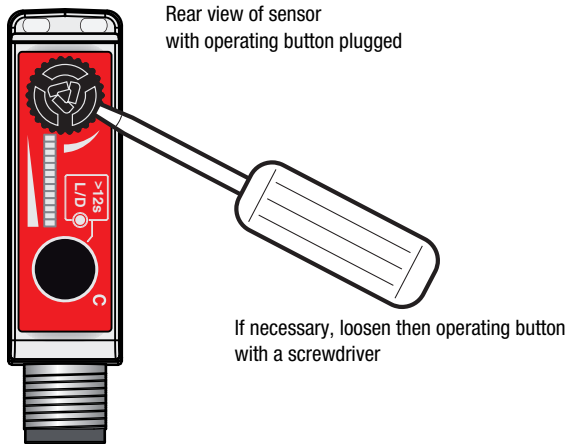

Color changeover

Contrast sensor KRT18B enables simple changeover of the detection color on the device. This is necessary if the contrast between the mark and the background is not sufficient for reliable detection with the set color.

Examples for optimum detection colors:

Color of the mark	Color of the background	Optimum detection color
Black	White	Any
Red	White	Green
Yellow	White	Blue
Green	White	Red
Black	Red	Red
Black	Green	Green
Black	Blue	Blue

In general, the optimum detection color can also be found by selecting the color for the which the largest signal difference is displayed between mark and background on the bar graph.

Press button **C** (Color) for 2 ... 7s (LEDs flash in sync with a frequency of 2Hz) and release.

Upon release of the button, the detection color changes to the next color (order: green, blue, red).

L/D – Light/dark switching

Press the C button longer than 12s.

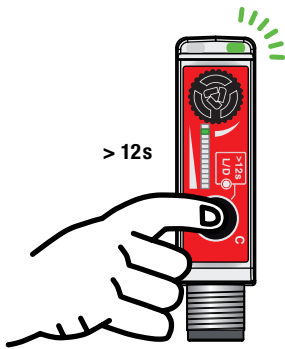

Only the green LED flashes.

Release the button.



LED on =

OUT1 (Pin 4): PNP light switching,
NPN dark switching

OUT2 (Pin 2) ¹⁾: PNP dark switching,
NPN light switching



LED off =

OUT1 (Pin 4): PNP dark switching,
NPN light switching

OUT2 (Pin 2) ¹⁾: PNP light switching,
NPN dark switching

1) Only for devices without analog output

To change the setting again, push the button again for longer than 12 s and release.

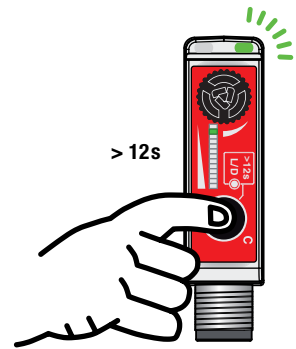

Sensor adjustments via the IN input (Pin 5)

i Signal level LOW $\leq 2V$
Signal level HIGH $\geq (U_B - 2V)$

Setting the detection color

Transmitter color RED

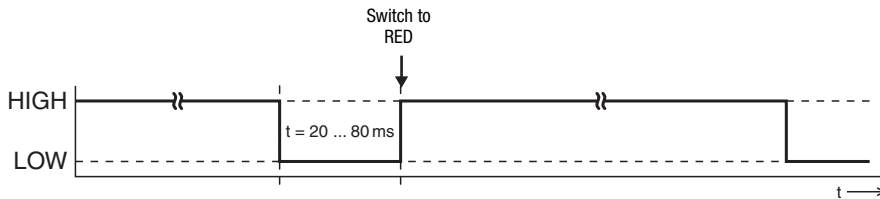

Transmitter color GREEN

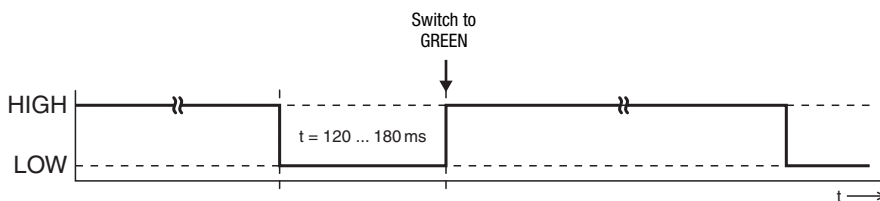

Transmitter color BLUE

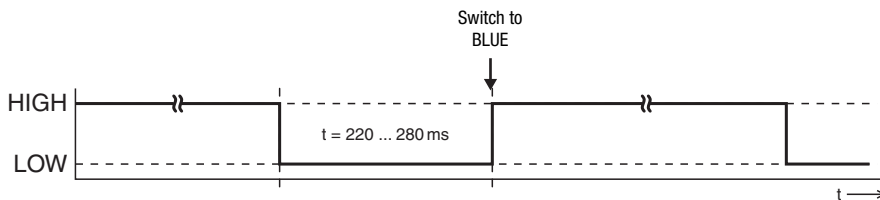

Light/dark switching

PNP light switching / light on, NPN dark switching / dark on (OUT1)

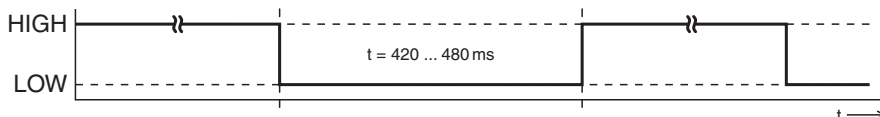

PNP dark switching / dark on, NPN light switching / light on (OUT1)

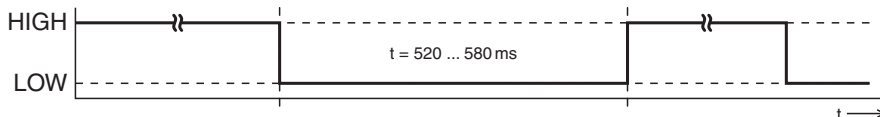

Locking all operational controls via the IN input (Pin 5)

i A static HIGH signal ($\geq 20ms$) at the IN input (Pin 5) locks all operational controls on the sensor if required, such that no manual operation is possible (e.g., protection from erroneous operation or manipulation).
If the input is not connected or if a static LOW signal is being applied, all operational controls are unlocked and can be operated freely.

